

# Casablanca Infinity B 2016

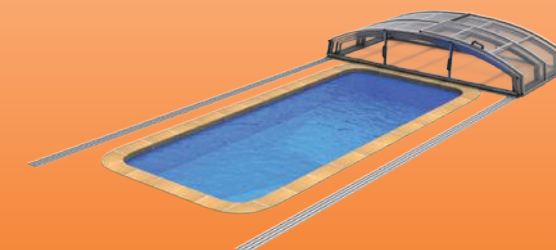

REVIZE: 2. 11. 2016

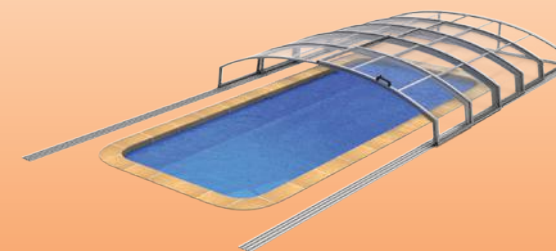
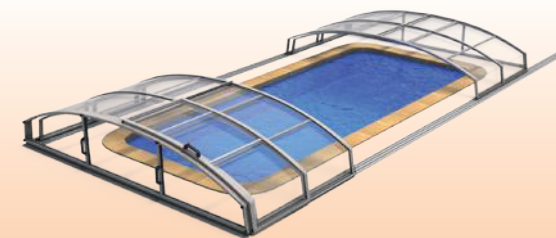
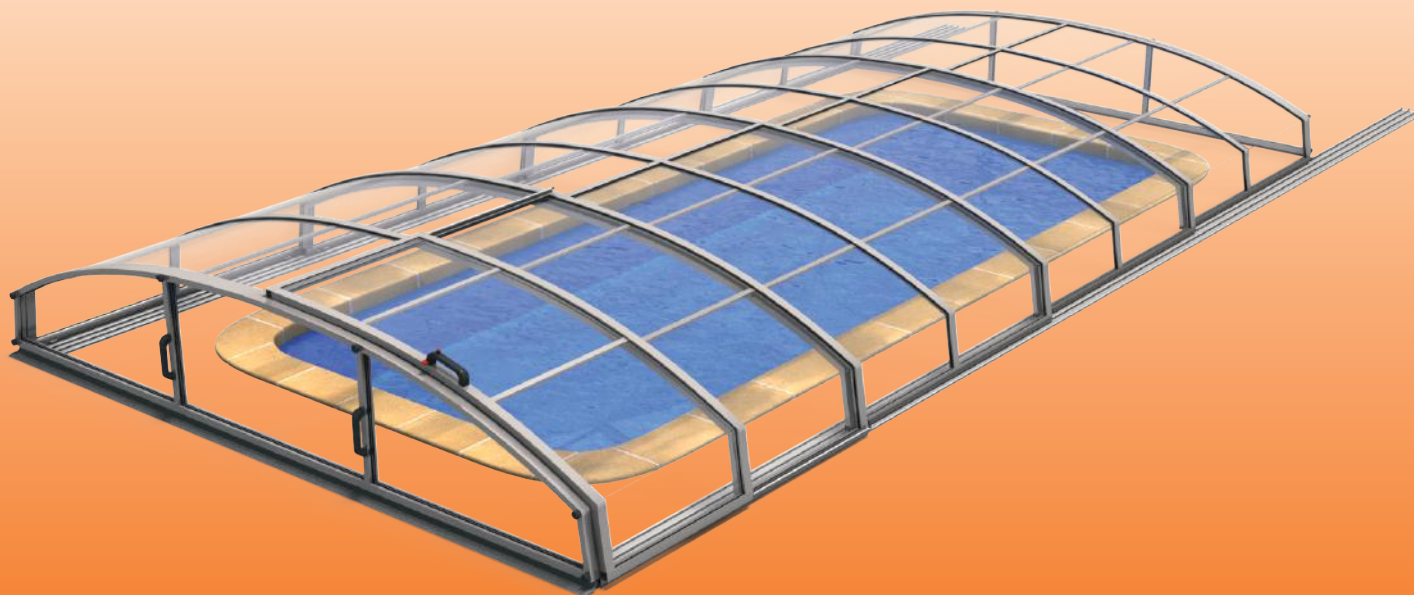
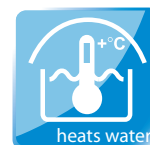

**BG**  
 Тръгването на Casablanca Infinity B 2016 е разрешено в България.  
 За повече информацията за условията на продажбата и гаранцията, моля да се свържете с дилъра.

**DE**  
 Verkauf und Installation von Casablanca Infinity B 2016 ist in Deutschland erlaubt.  
 Für weitere Informationen zu den Verkaufsbedingungen und der Garantie, wenden Sie sich bitte an den Händler.

**ES**  
 Casablanca Infinity B 2016 está autorizado para venderse e instalarse en España.  
 Para más información sobre las condiciones de venta y la garantía, póngase en contacto con el distribuidor.

**FR**  
 La vente et l'installation de Casablanca Infinity B 2016 sont autorisées en France.  
 Pour plus d'informations sur les conditions de vente et la garantie, contactez votre distributeur.

**HU**  
 A Casablanca Infinity B 2016 eladását és telepítését engedélyezik Magyarországon.  
 További információkért forduljon a kereskedőhöz.

**CN**  
 Casablanca Infinity B 2016 获准在中国大陆销售和安装。  
 欲了解有关销售条件和保修的更多信息，请联系经销商。

**LT**  
 Casablanca Infinity B 2016 yra leidžiama parduoti ir instaliuoti Lietuvoje.  
 Dėl papildomos informacijos apie pardavimo sąlygas ir garantiją, kreipkitės į pardavėją.

**PL**  
 Sprzedaż i instalacja Casablanca Infinity B 2016 jest dozwolona w Polsce.  
 Więcej informacji o warunkach sprzedaży i gwarancji, prosimy o kontakt z dystrybucyjnym punktem sprzedaży.

**RU**  
 Продажа и установка Casablanca Infinity B 2016 разрешены в России.  
 Для получения дополнительной информации о условиях продажи и гарантии, пожалуйста, обратитесь к дилеру.

**SL**  
 Prodaja in namestitava Casablanca Infinity B 2016 sta dovoljena v Sloveniji.  
 Za več informacij o pogoje prodaje in garancije, se obrnite na prodajalca.

**CZ**  
 Prodej a instalace Casablanca Infinity B 2016 je povolena v České republice.  
 Pro více informací o podmínkách prodeje a záruce, obraťte se na prodejce.

**DK**  
 Casablanca Infinity B 2016 er tilladt til salg og installation i Danmark.  
 For yderligere oplysninger om salgsbetingelser og garanti, bedes du kontakte din forhandler.

**EE**  
 Casablanca Infinity B 2016 on lubatud müüa ja paigaldada Eestis.  
 Täpsemate informatsioonide saamiseks palun võtta ühendust müüjaga.

**GB**  
 The swimming pool enclosure may be sold and installed in the United Kingdom.  
 For more information on the terms of sale and warranty, please contact your retailer.

**HR**  
 Prodaja i instalacija Casablanca Infinity B 2016 dozvoljena je u Hrvatskoj.  
 Za više informacija o uvjetima prodaje i garanciji, obratite se trgovcu.

**IT**  
 La vendita e l'installazione di Casablanca Infinity B 2016 sono autorizzate in Italia.  
 Per maggiori informazioni sulle condizioni di vendita e la garanzia, rivolgetevi al rivenditore.

**LV**  
 Casablanca Infinity B 2016 ir atļauts pārdot un uzstādīt Latvijā.  
 Par papildu informāciju par pārdošanas nosaukumiem un garantiju, lūdzam sazināties ar pārdevēju.

**RO**  
 Vânzarea și instalarea Casablanca Infinity B 2016 este autorizată în România.  
 Pentru mai multe informații despre condițiile de vânzare și garanție, vă rugăm să contactați vânzătorul.

**SE**  
 Casablanca Infinity B 2016 är tillåtet att sälja och installera i Sverige.  
 För ytterligare information om försäljningsvillkor och garanti, vänligen kontakta din återförsäljare.

**SK**  
 Prodej a instalace Casablanca Infinity B 2016 je povolena v Slovenskej republice.  
 Pro viac informacii o podmienkach predaja a záruky, obratite sa na predavcu.

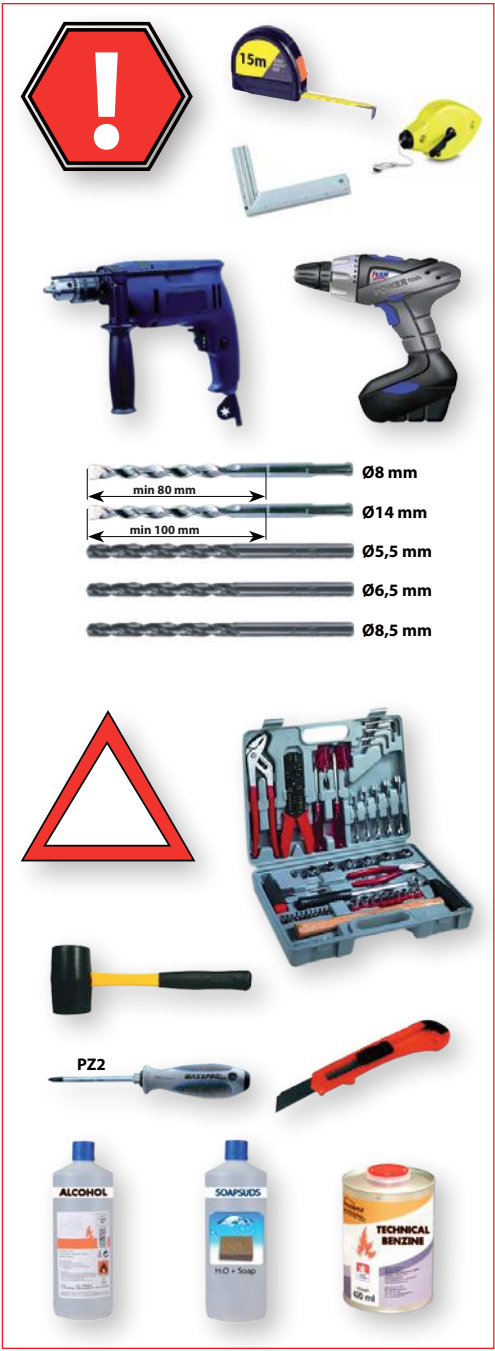

650.01.8811.2

DIN 7982  
4,8 x 13  
20 x  
1

650.01.8811.2

16x  
2

AN 9051  
6,3 x 50  
52x  
3

007.20.1501.2

6x  
4

DIN 7976  
6,3 x 38  
6x  
5

650.01.0021.2

4x  
6

007.02.0030.2

Ø4 x 10  
114x  
7

007.20.1605.2

1x  
8

007.10.7012.2

Ø8 x 80  
88x  
9

007.02.0092.2

Ø4 x 14  
6x  
11

007.90.4505.2

4x  
12

AN 9051  
6,3 x 38  
20x  
13

Ø4,2  
1x  
14

1x  
17

1x  
18

097.02.0046.2

3x  
19

097.02.0047.2

3x  
20

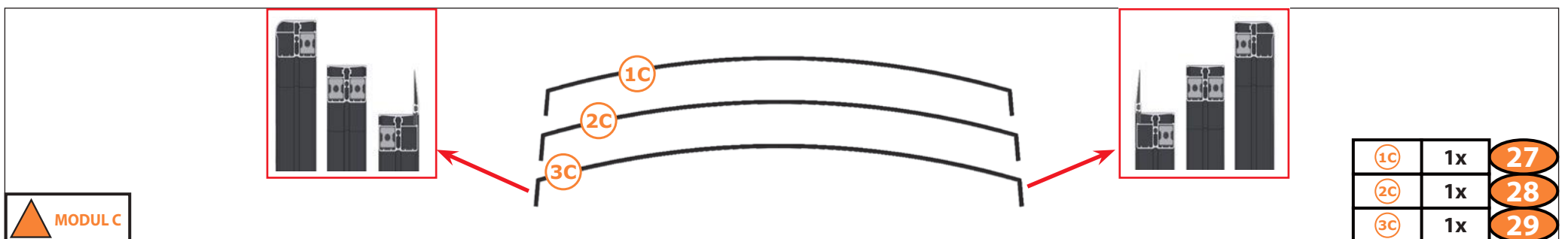
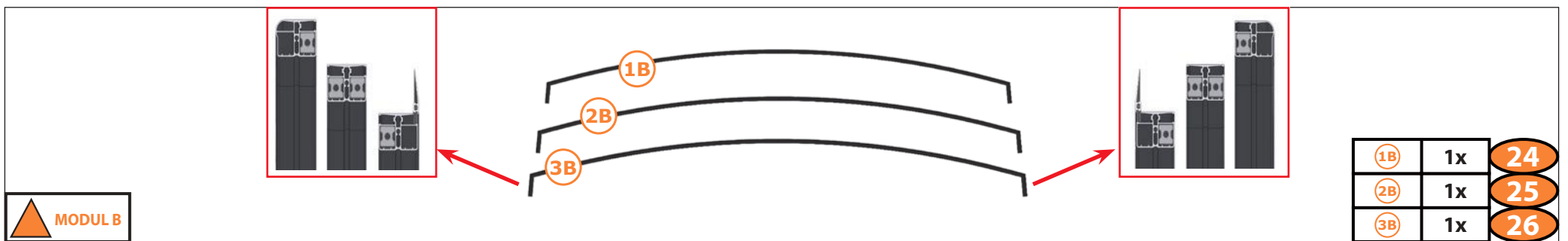
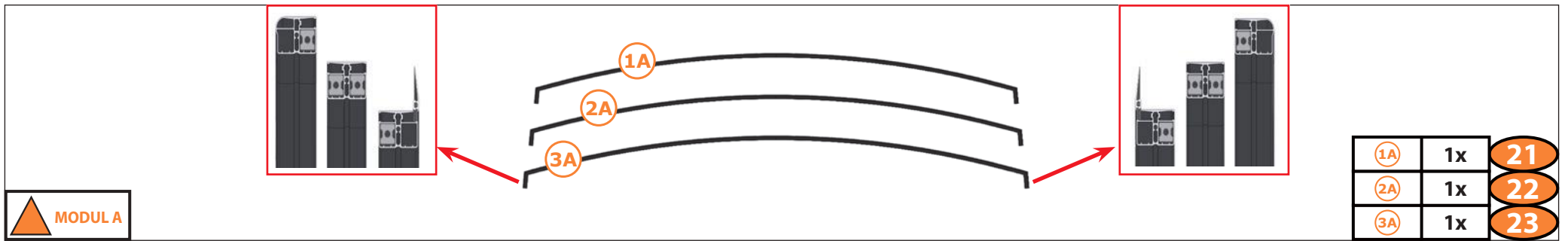
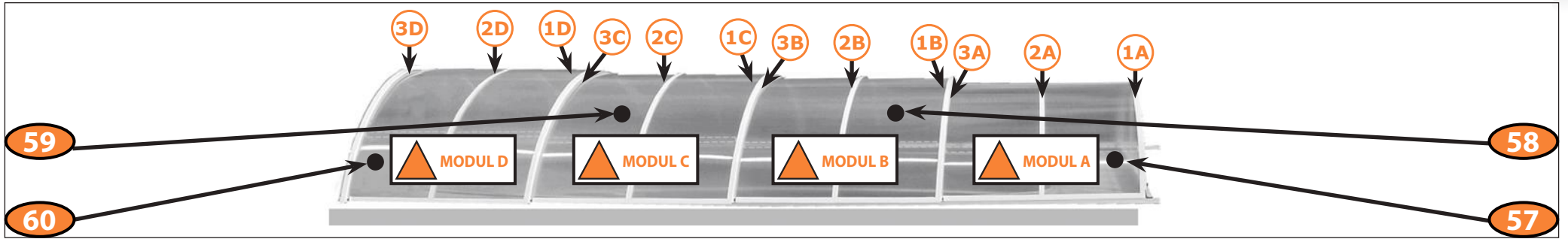



**MODUL D**

1D	1x	30
2D	1x	31
3D	1x	32

1041 mm
48x
36

6x
37



<b>A</b>
3230 mm
4x
<b>41</b>

<b>B</b>
2140 mm
4x
<b>43</b>

<b>D</b>
3230 mm
4x
<b>47</b>

<b>D</b>
3230 mm
16x
<b>48</b>

<b>D</b>
2140 mm
8x
<b>49</b>

<b>MODUL D</b>
1x
<b>50</b>

<b>MODUL D</b>
1x
<b>51</b>

<b>MODUL B</b>
<b>MODUL C</b>
2x
<b>52</b>



**MODUL B**  
**MODUL C**

2x  
**53**

**MODUL A**

1x  
**54**

**MODUL A**

1x  
**55**

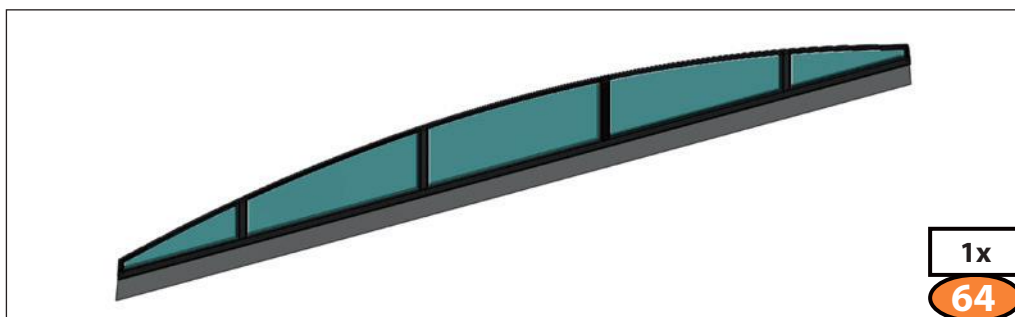
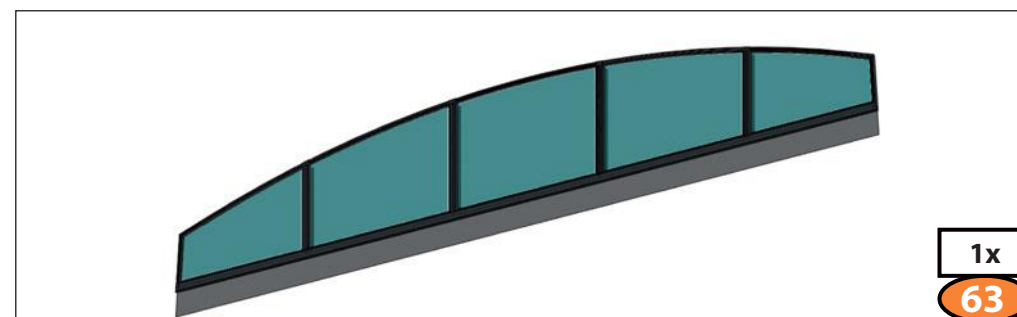
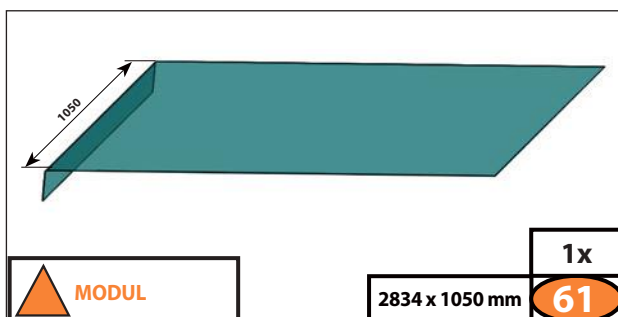
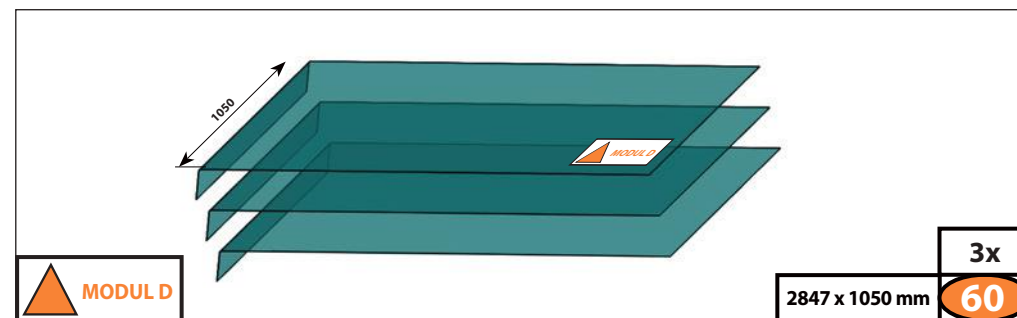
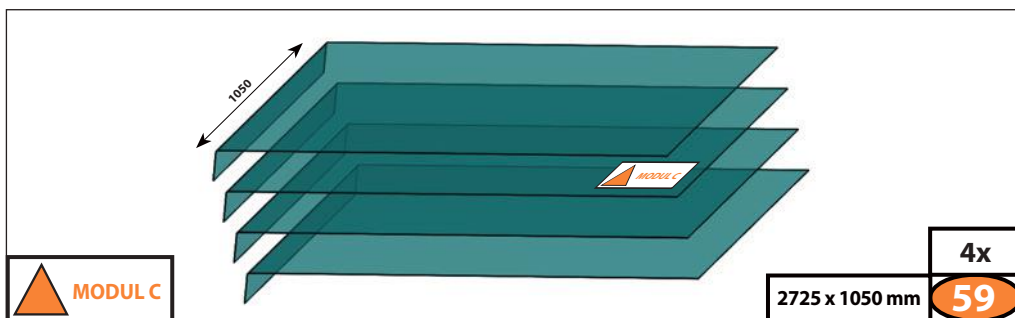
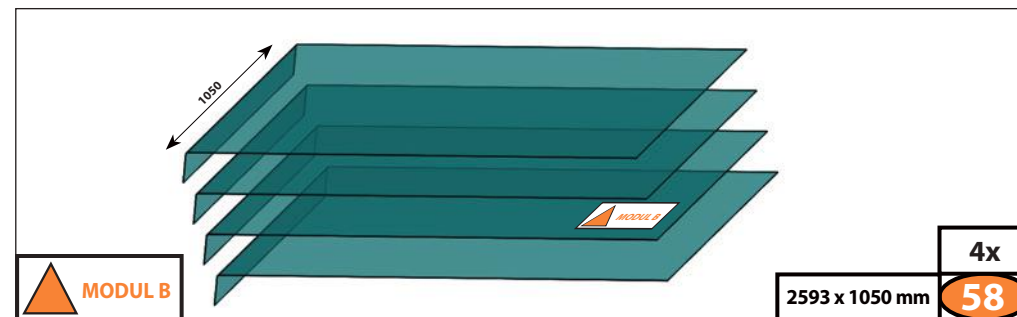
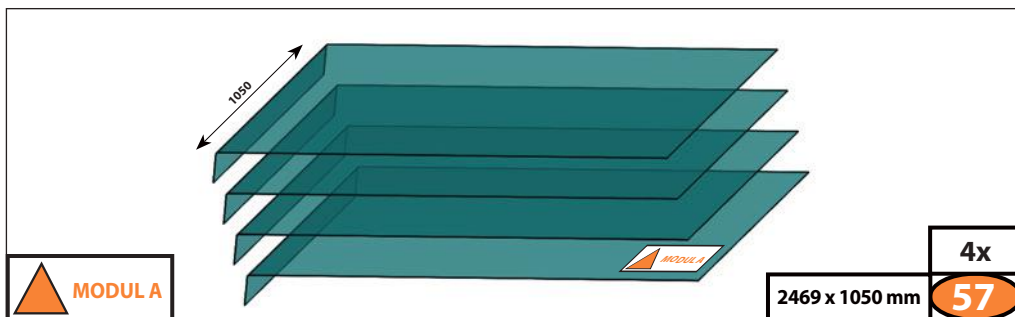



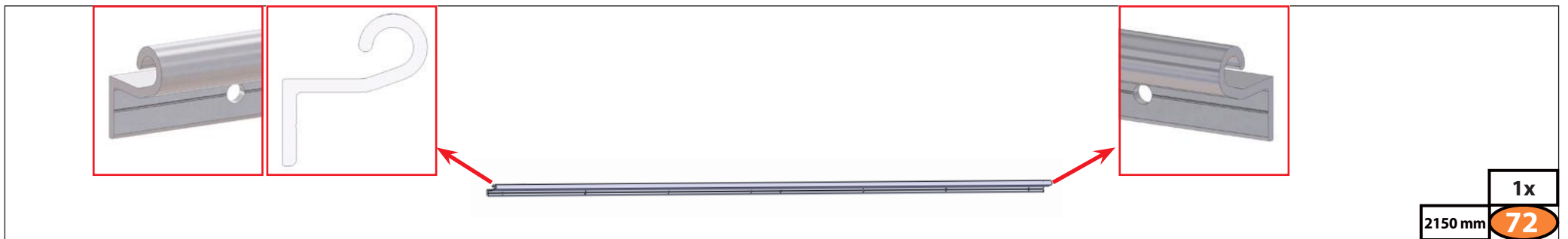
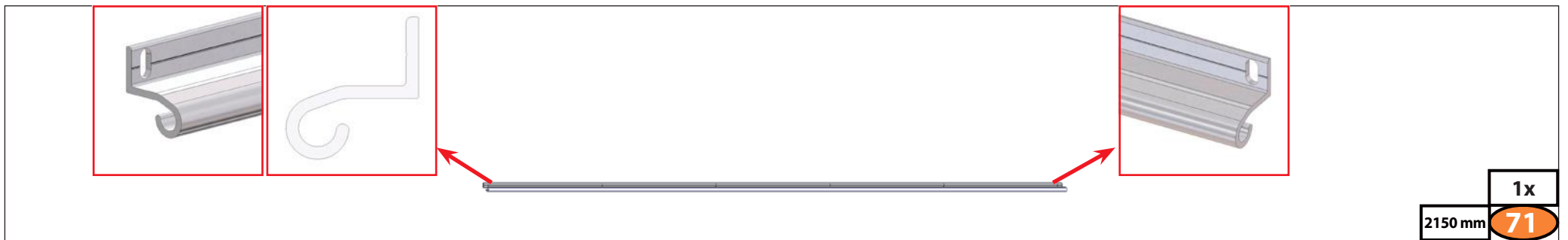
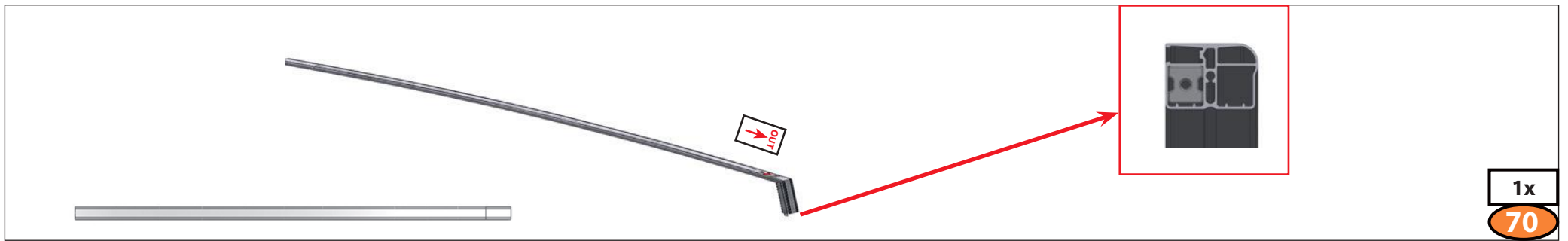
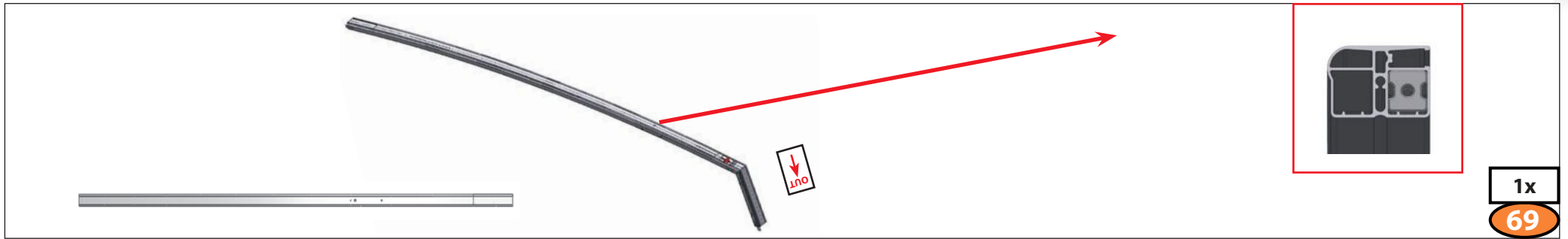

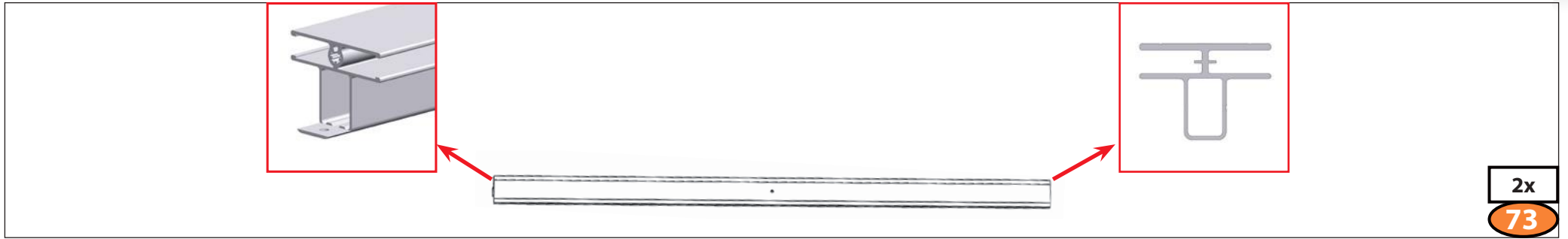

2x  
73

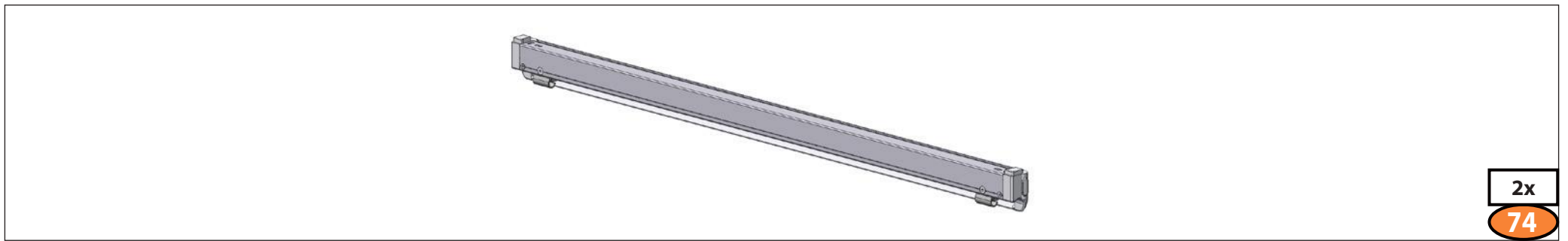

2x  
74

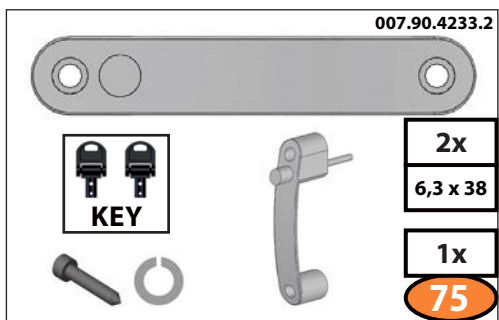

2x  
6,3 x 38  
1x  
75



6,3 x 19  
10x  
77

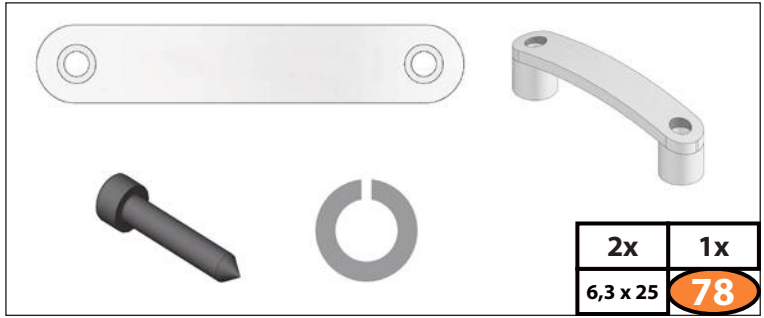

2x 1x  
6,3 x 25 78

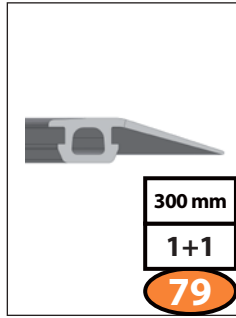

300 mm  
1+1  
79

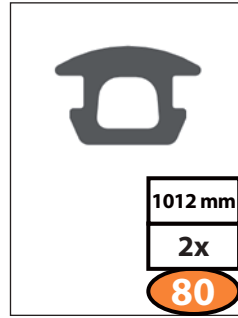

1012 mm  
2x  
80

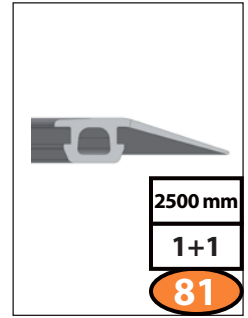

2500 mm  
1+1  
81



Diagram showing two horizontal bars at the top. A red box contains a grey arrow pointing up with three horizontal lines below it. A table to the right lists dimensions and quantity.

2469 mm	8x
1050 mm	8x

**92**

**MODUL A**

Diagram showing two horizontal bars at the top. A red box contains a grey arrow pointing up with three horizontal lines below it. A table to the right lists dimensions and quantity.

2593 mm	8x
1050 mm	8x

**93**

**MODUL B**

Diagram showing two horizontal bars at the top. A red box contains a grey arrow pointing up with three horizontal lines below it. A table to the right lists dimensions and quantity.

2725 mm	8x
1050 mm	8x

**94**

**MODUL C**

Diagram showing two horizontal bars at the top. A red box contains a grey arrow pointing up with three horizontal lines below it. A table to the right lists dimensions and quantity.

2847 mm	6x
1050 mm	6x

**96**

**MODUL D**

Diagram showing two horizontal bars at the top. A red box contains a grey arrow pointing up with three horizontal lines below it. A table to the right lists dimensions and quantity.

2834 mm	2x
1050 mm	2x

**97**

**MODUL D**

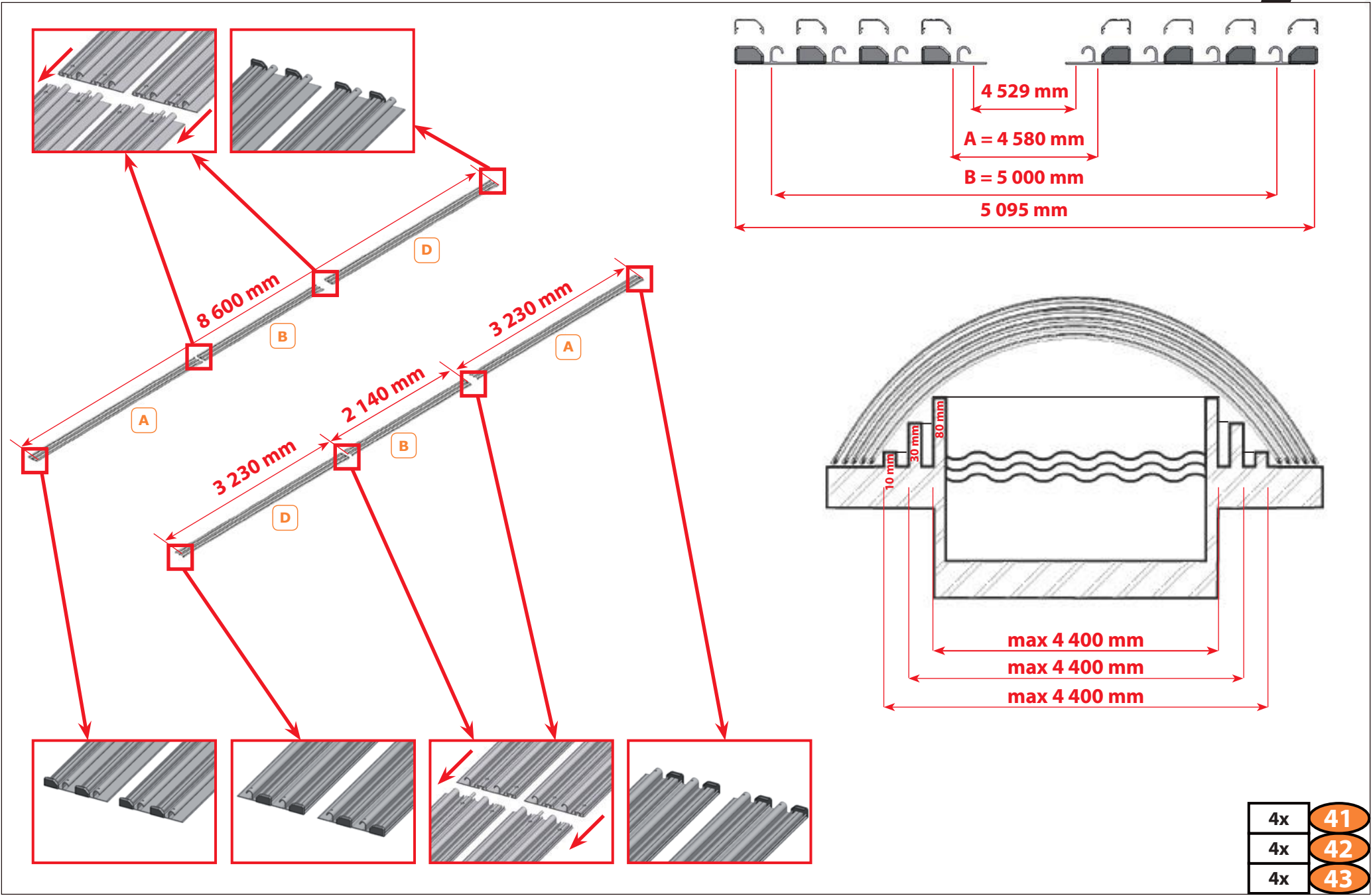

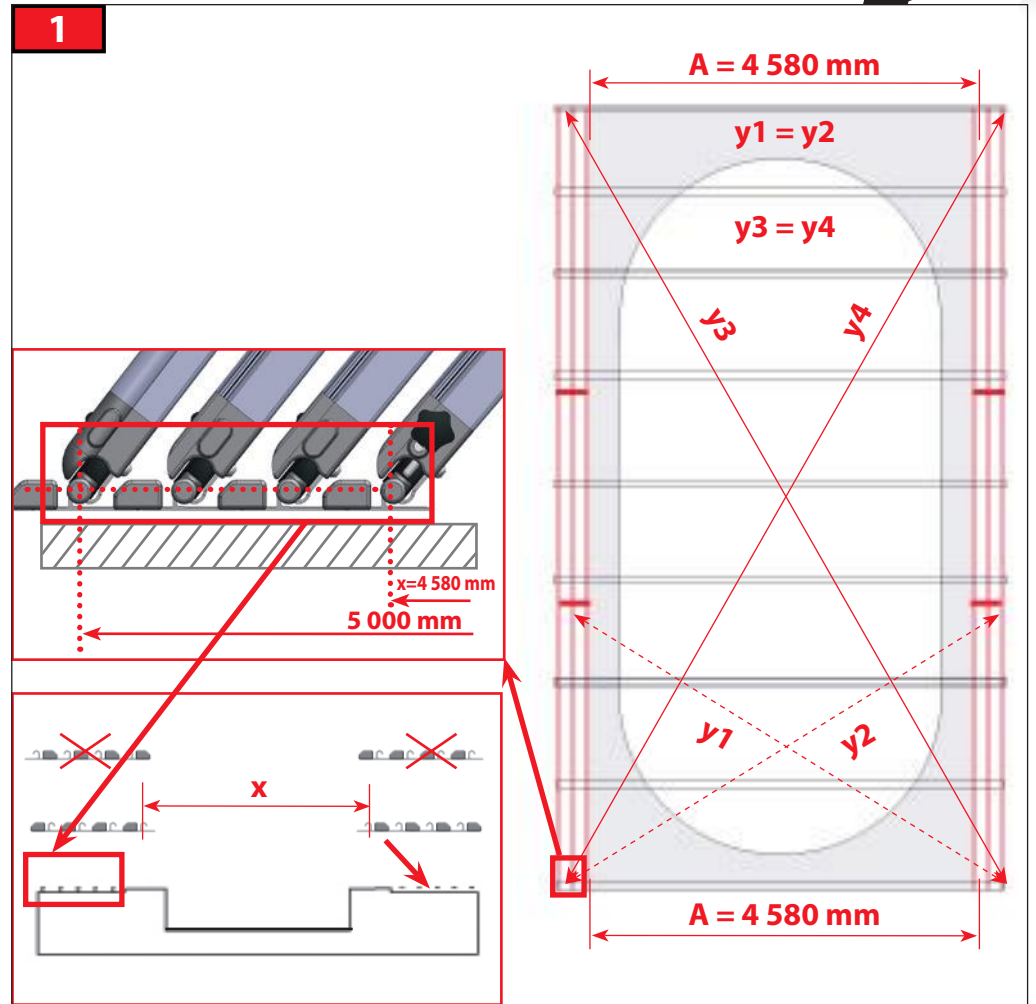
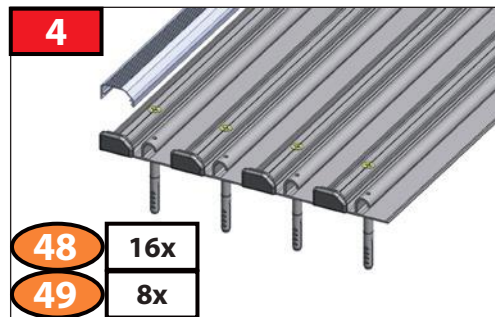
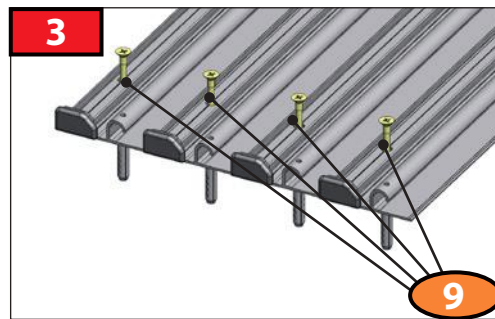
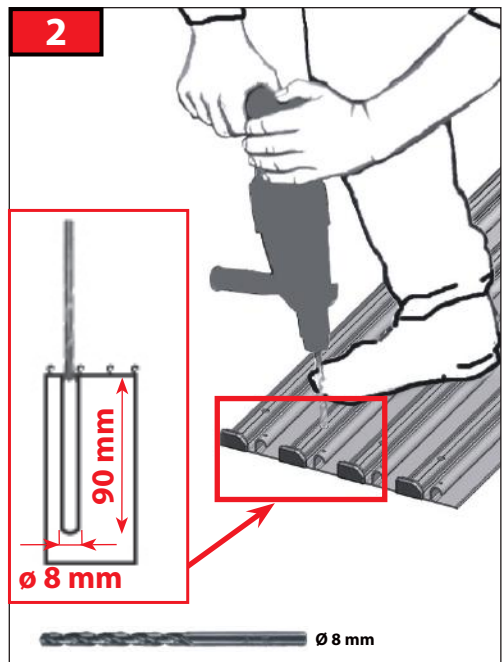
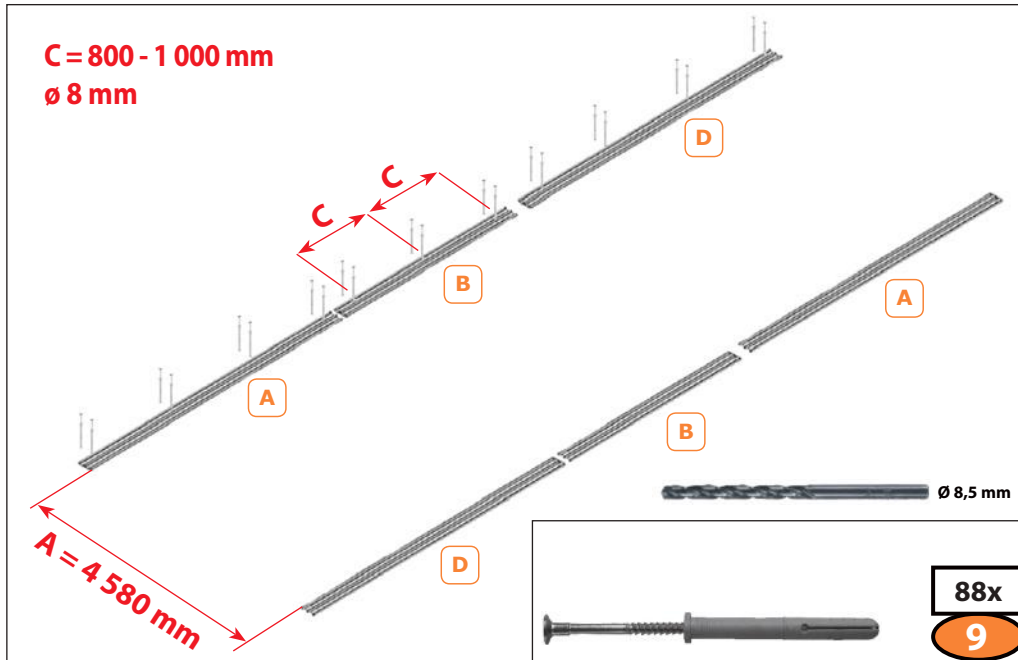



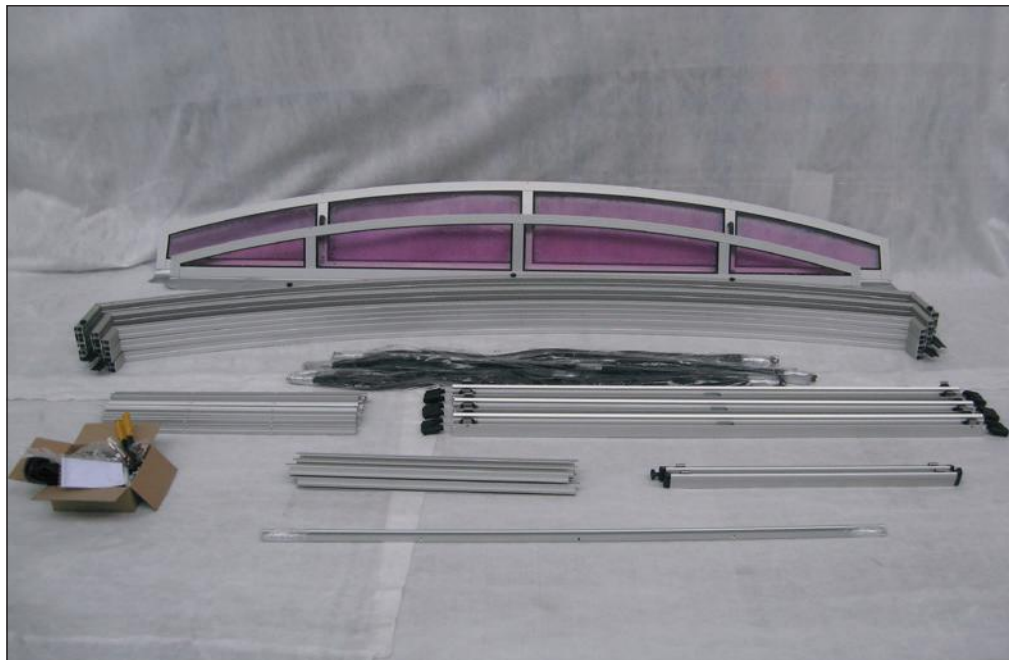



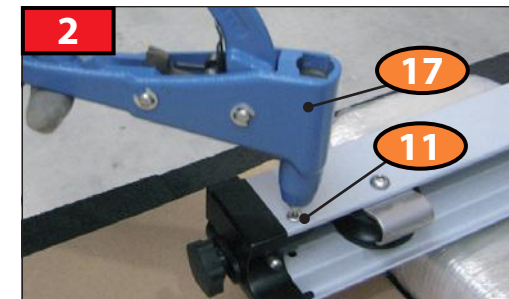
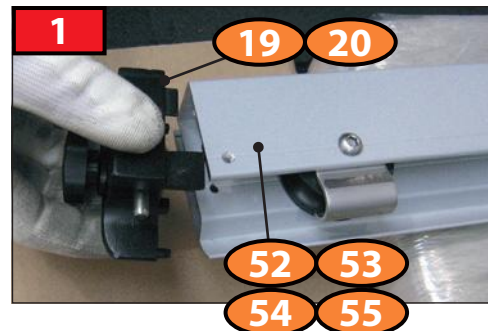
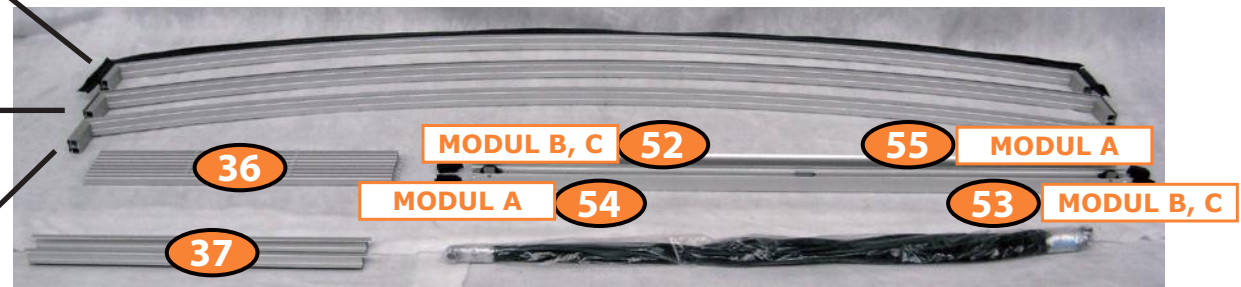
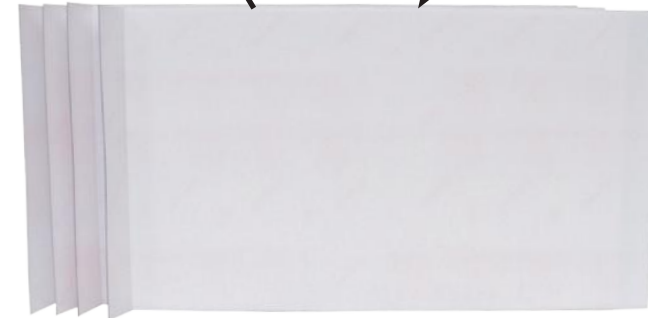
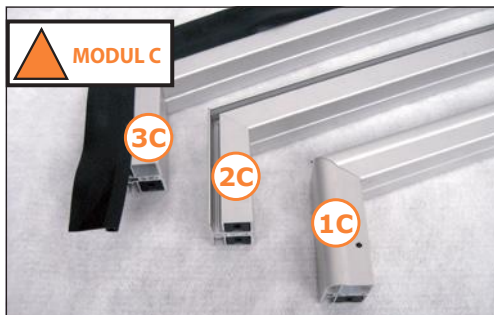
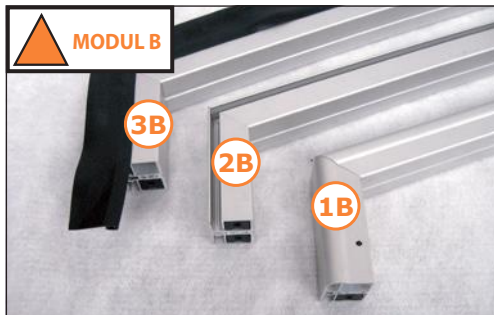
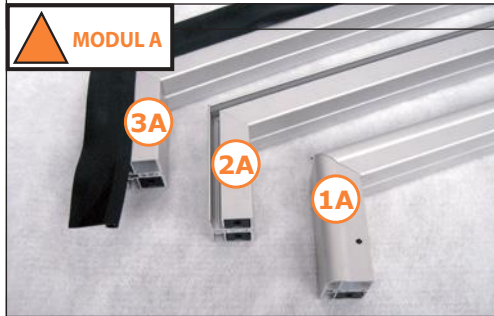

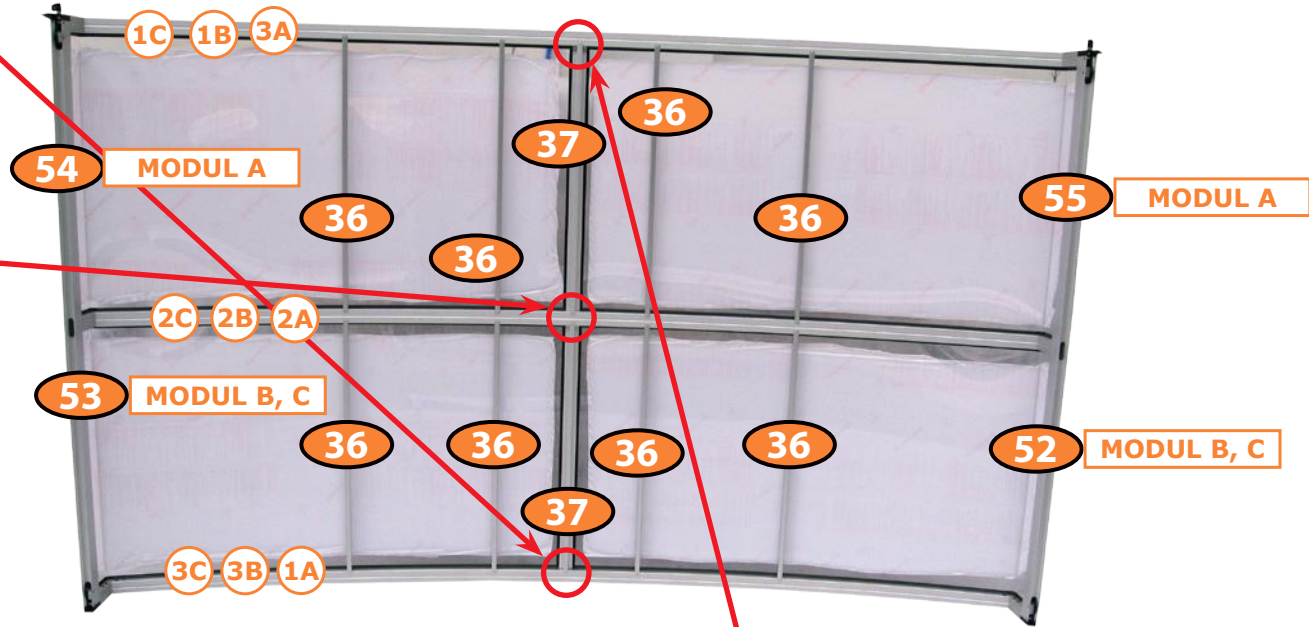
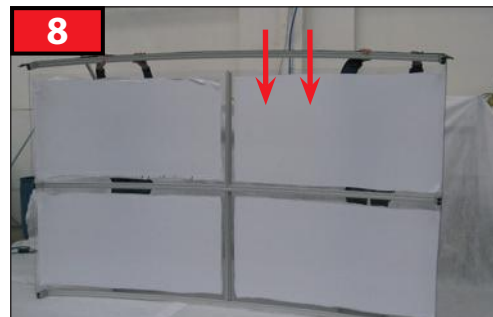
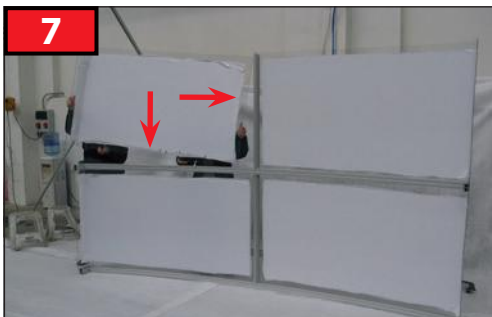
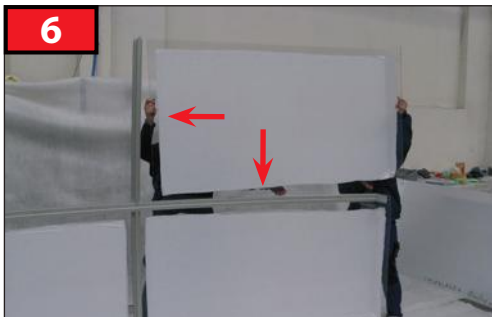
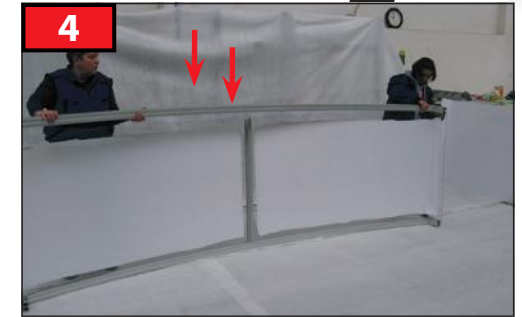
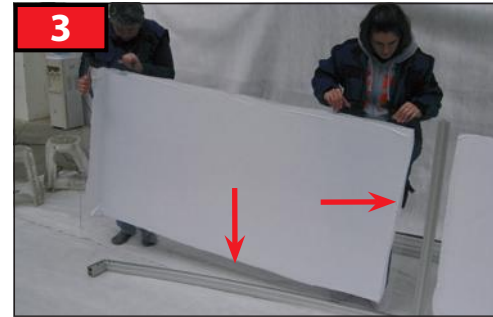



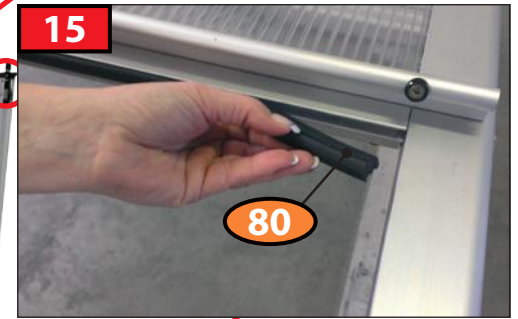
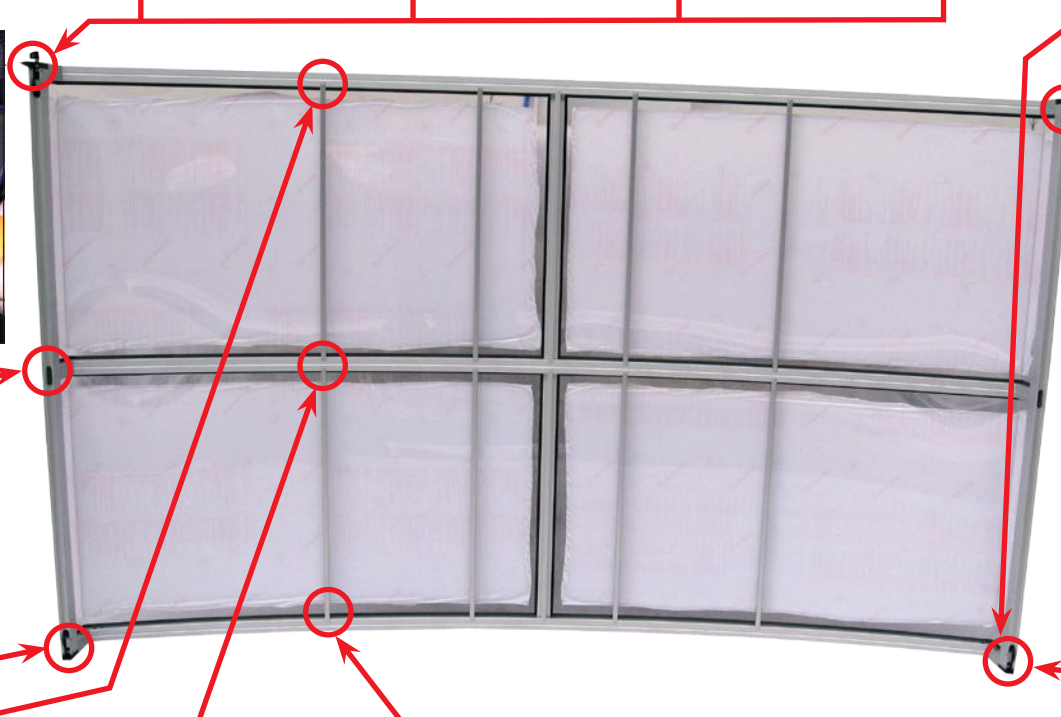
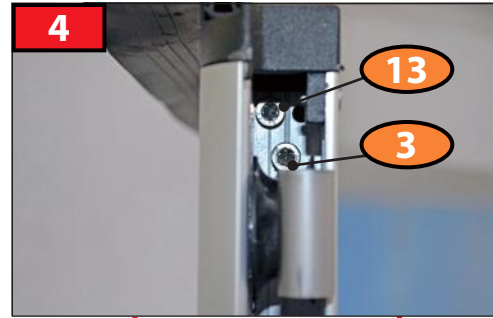
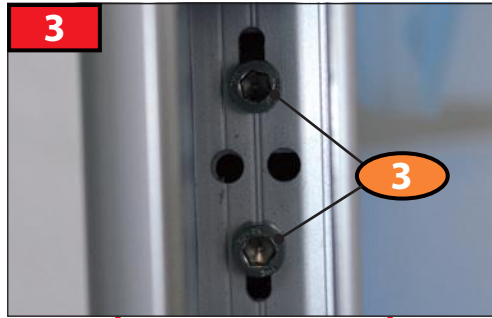
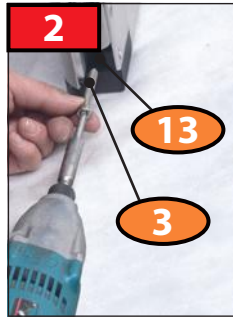

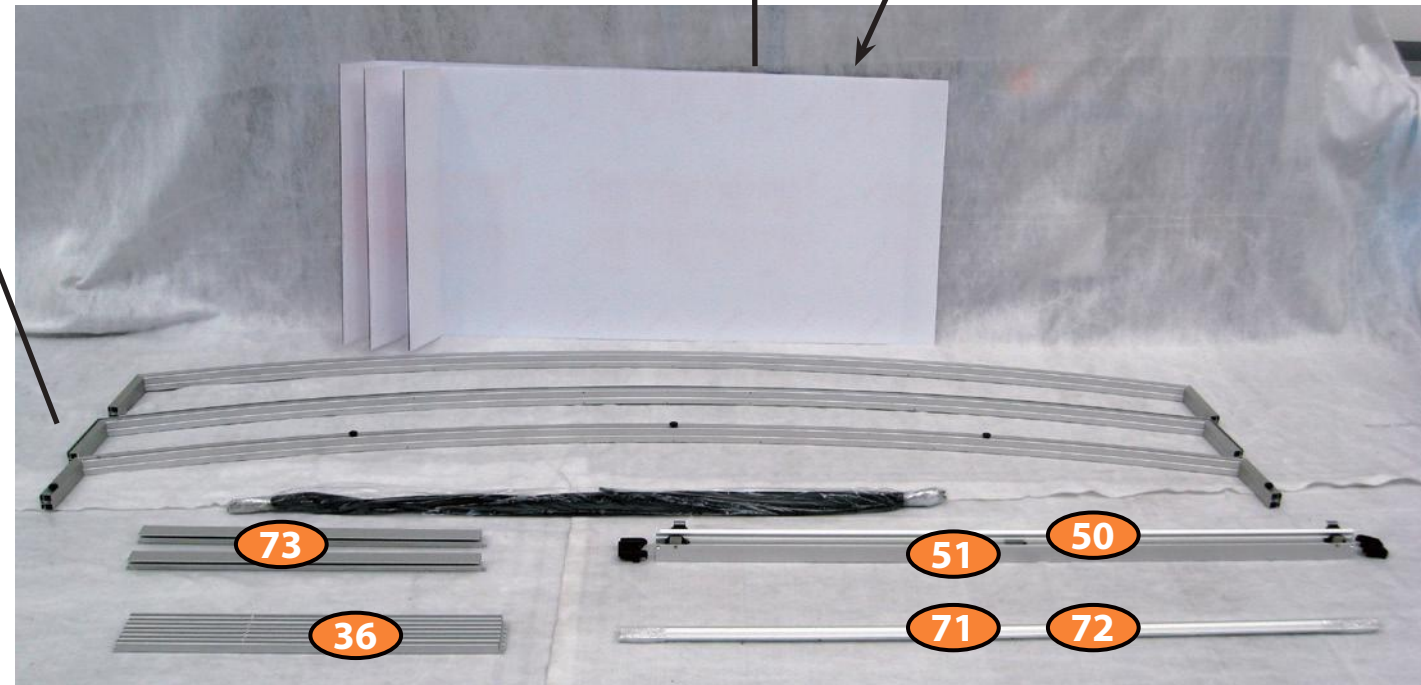
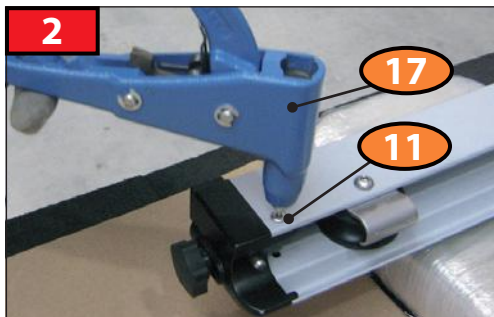
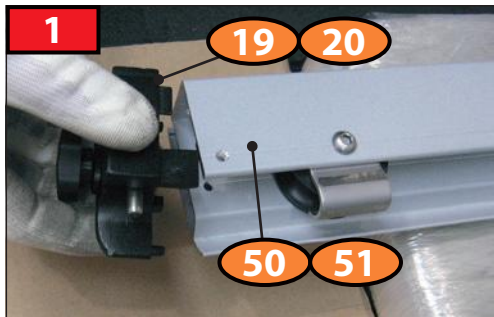
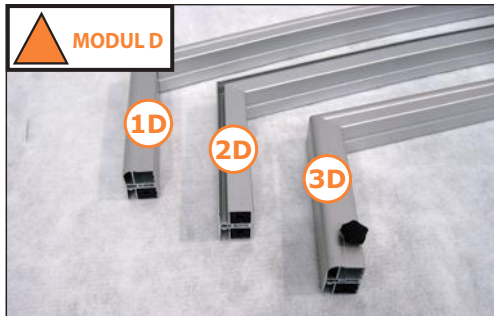





### DOOR LEFT

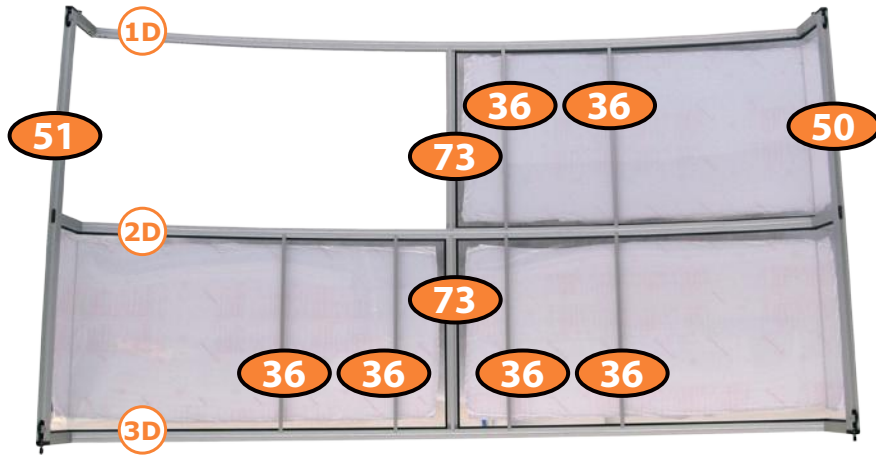

### DOOR RIGHT

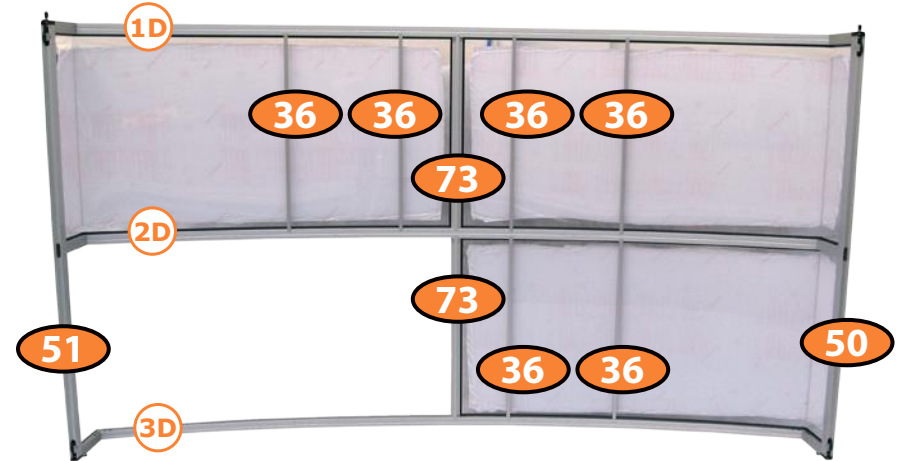
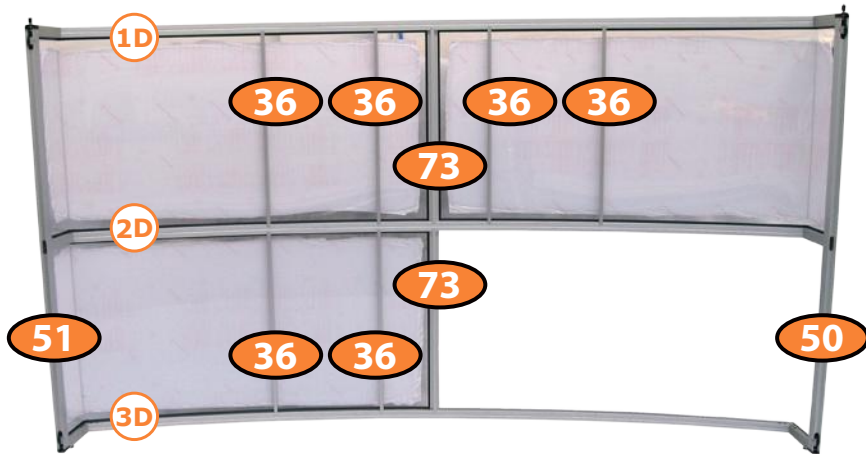
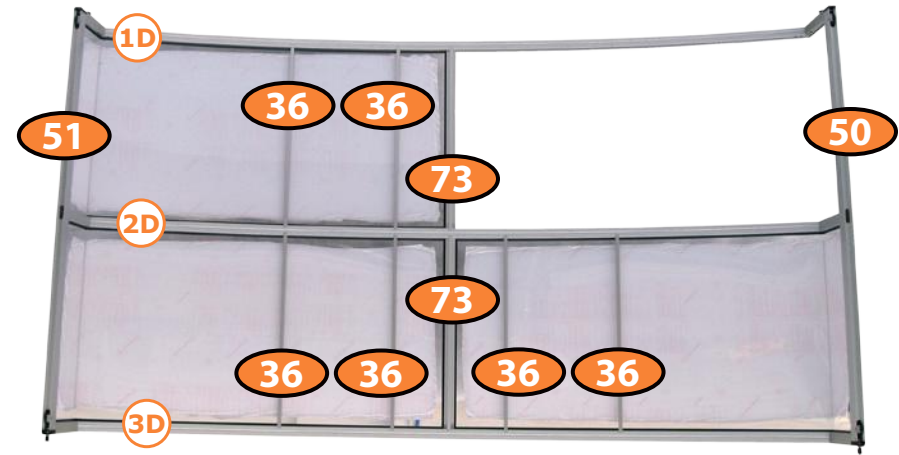

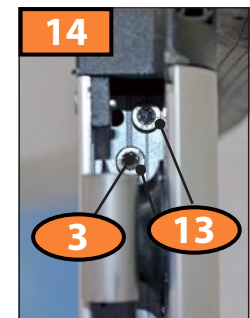
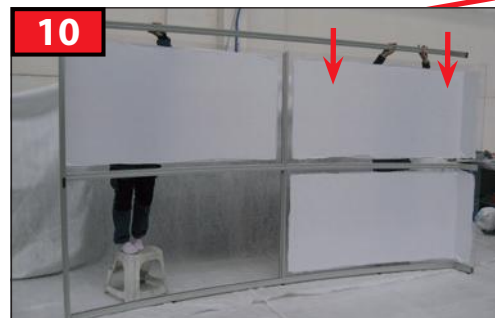
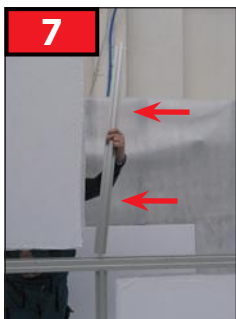
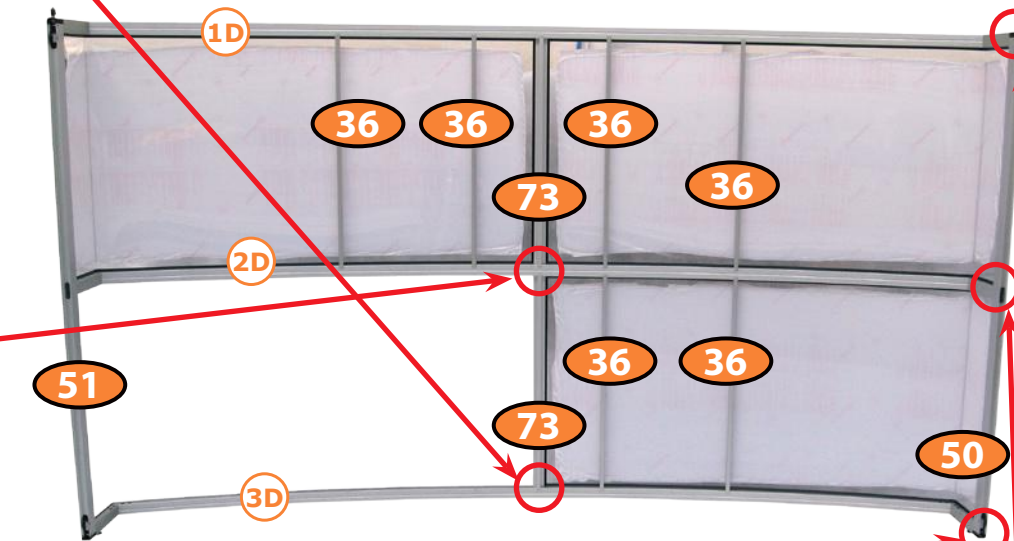
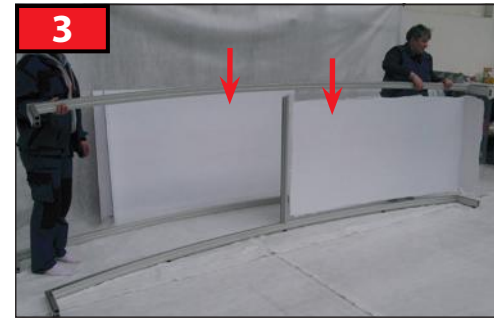
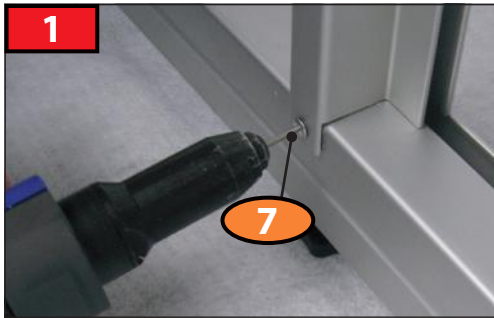



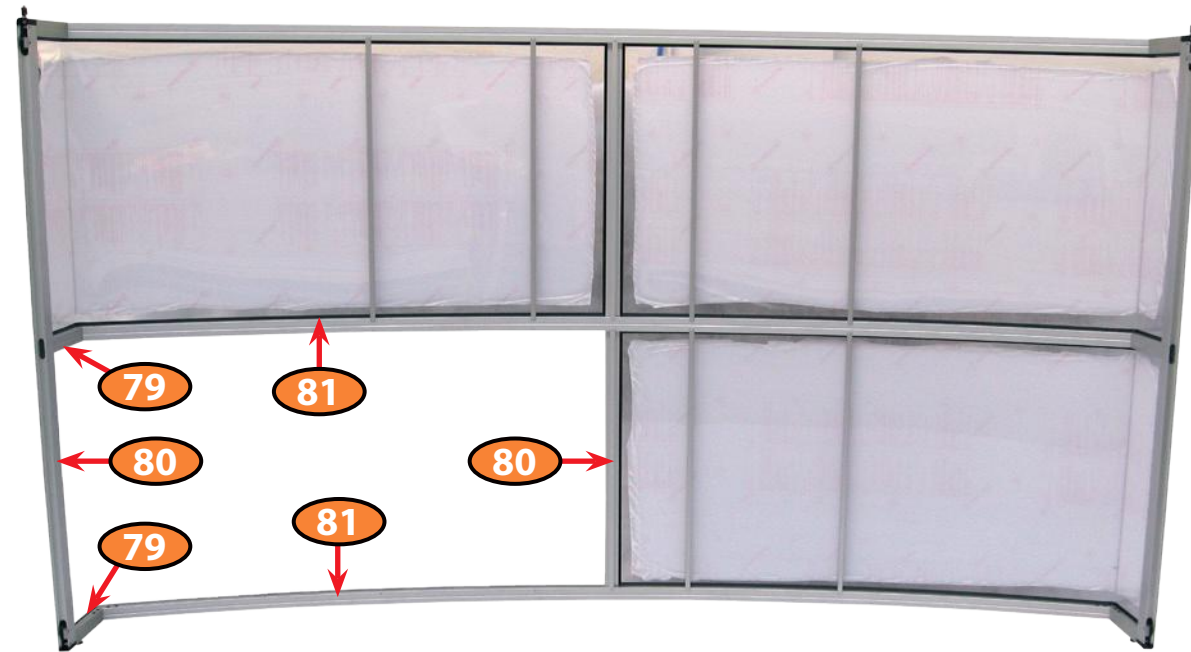
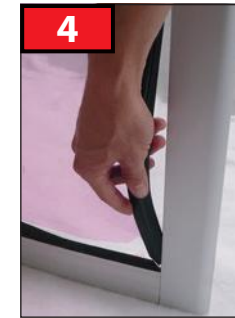
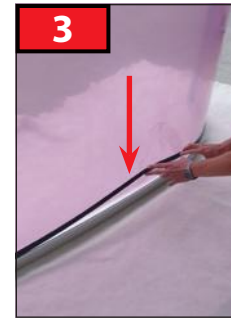

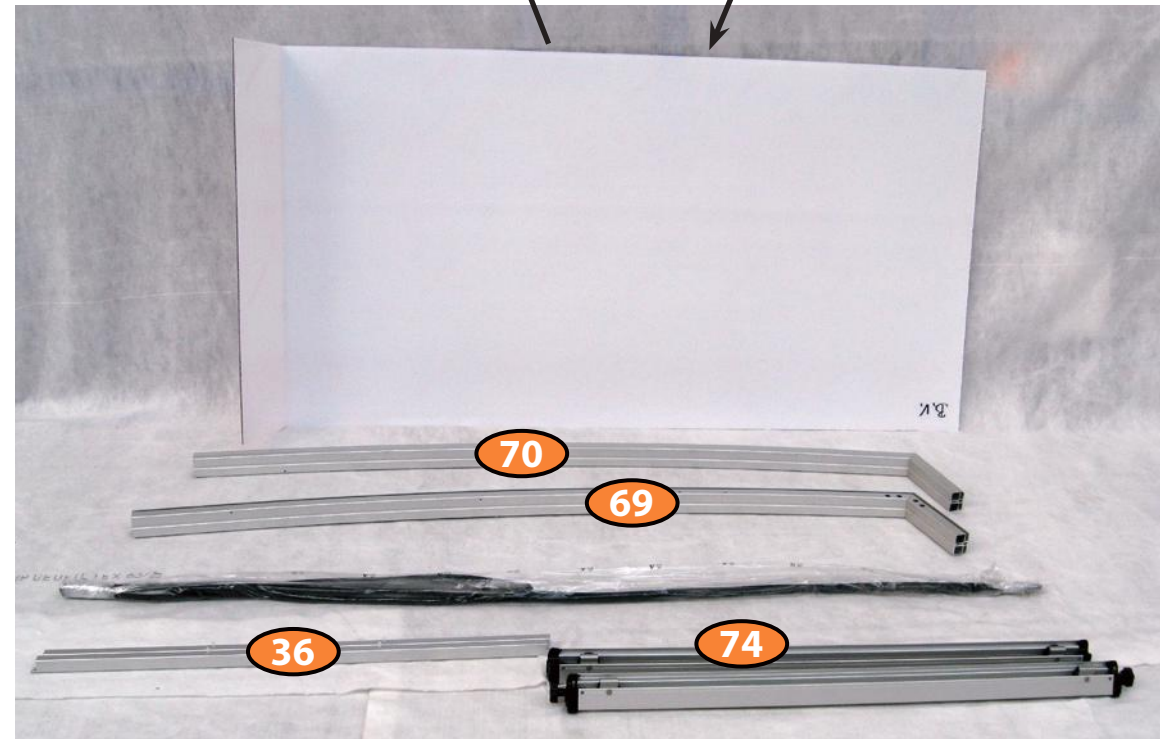
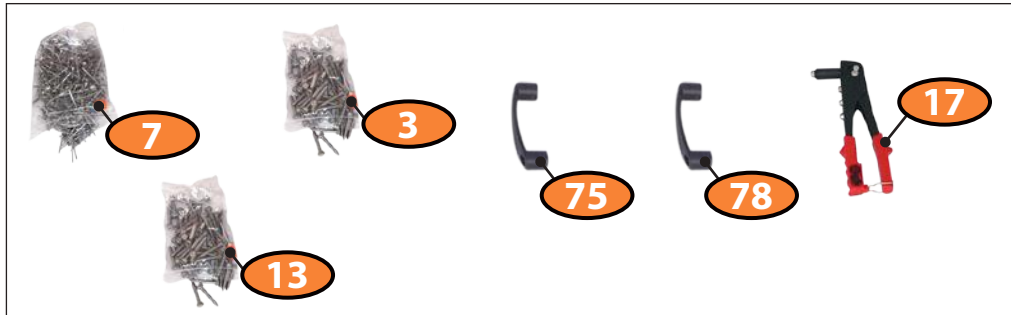

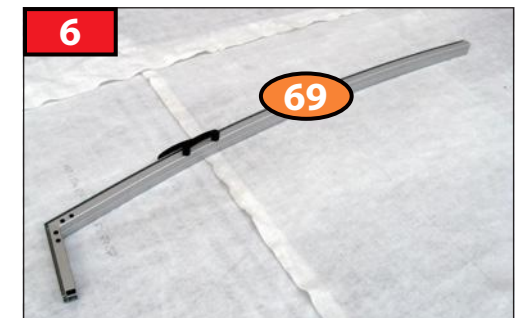



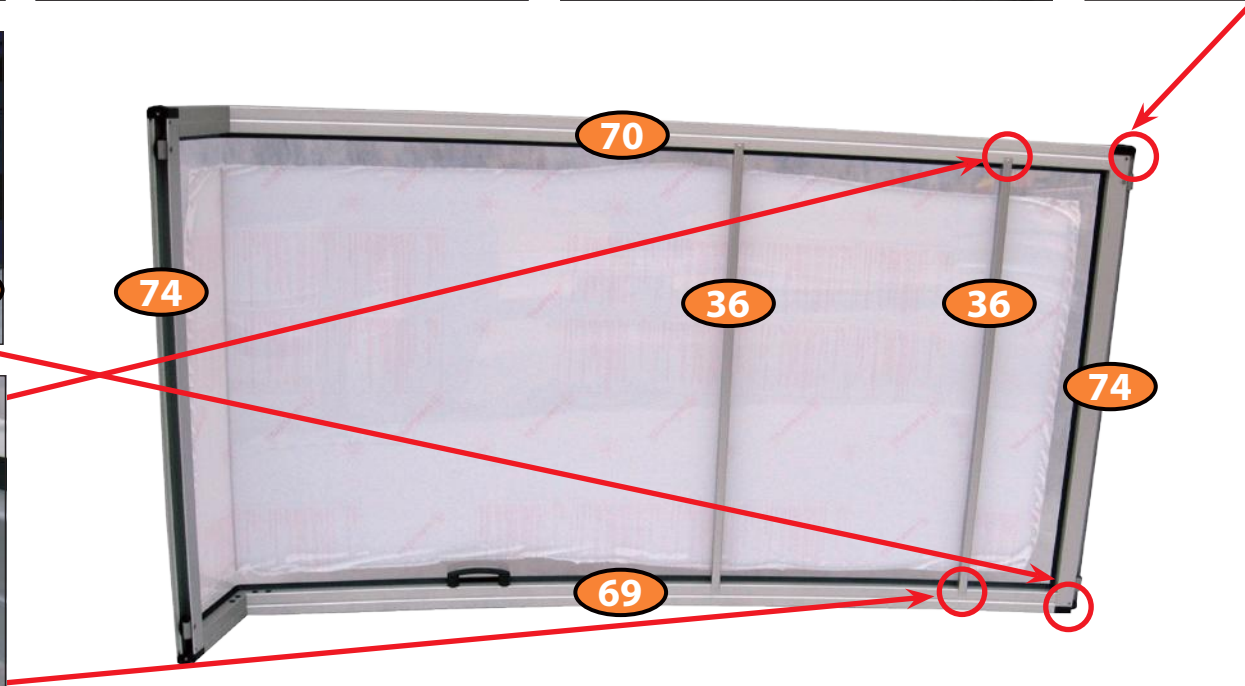
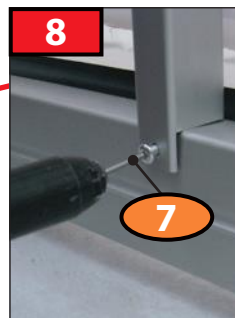
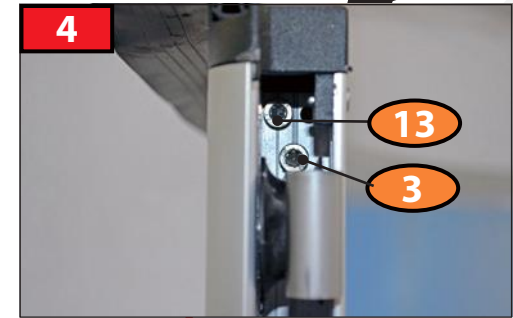
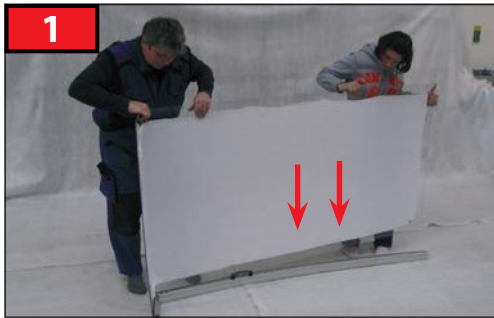

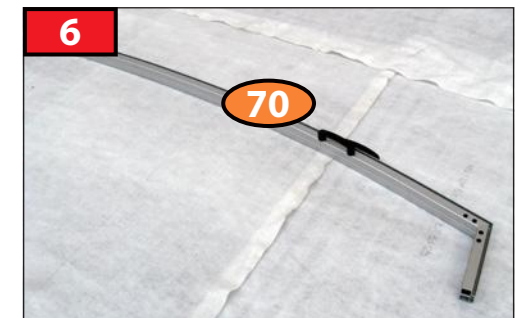

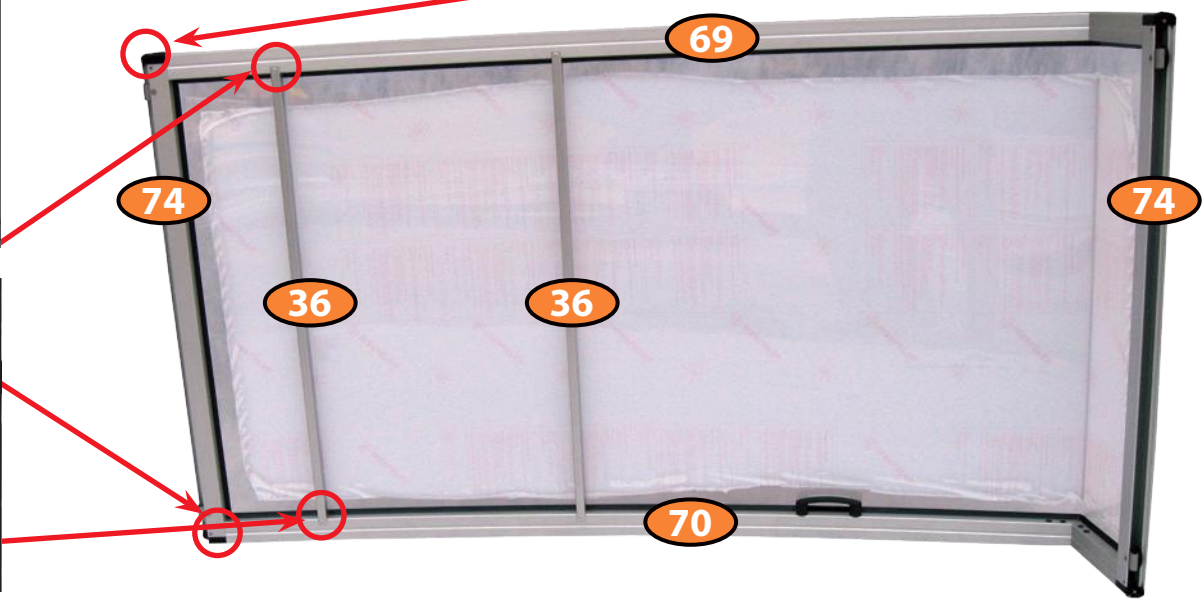
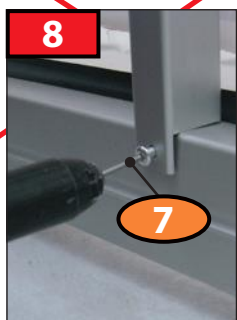
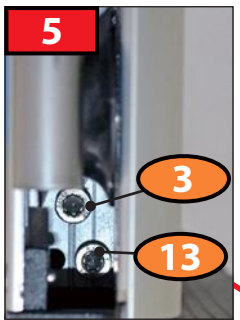
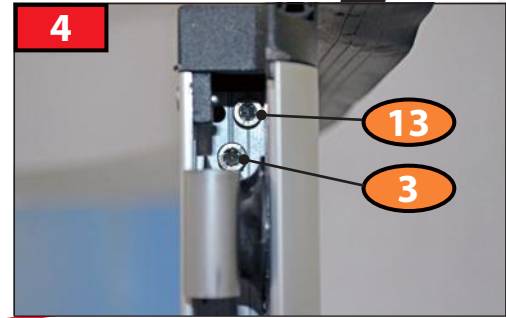
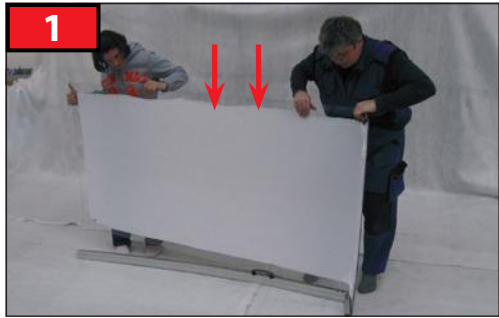



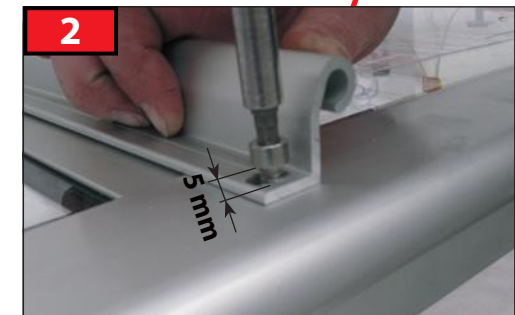
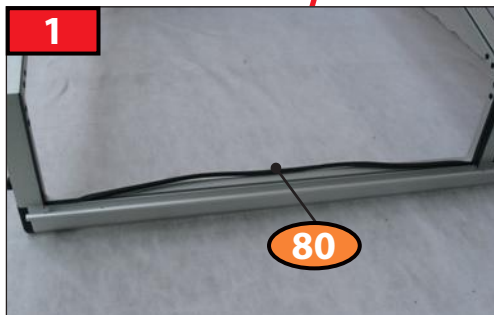
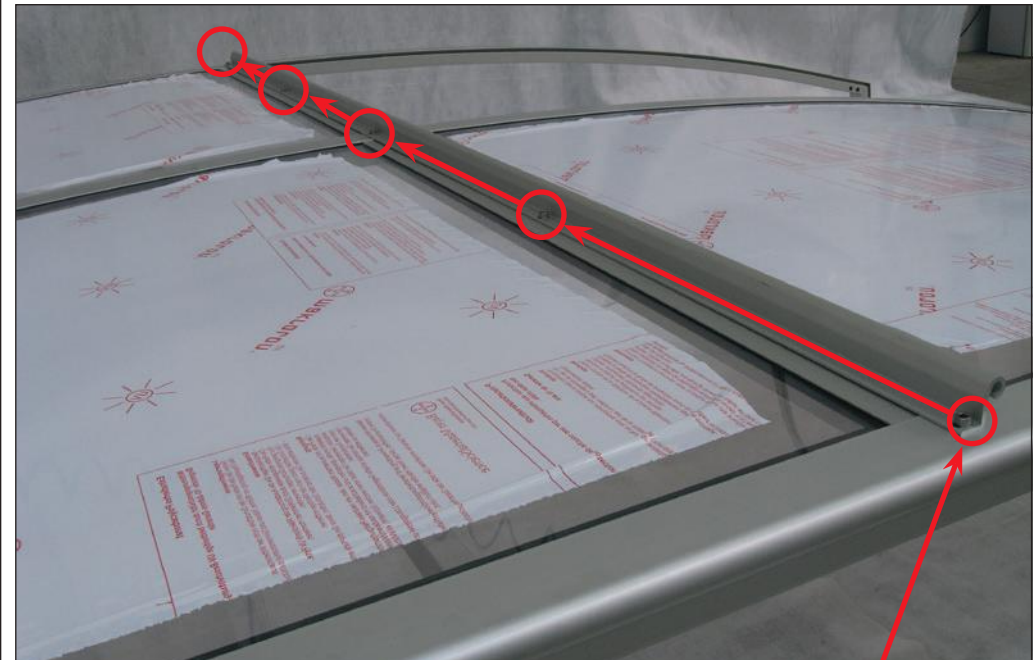
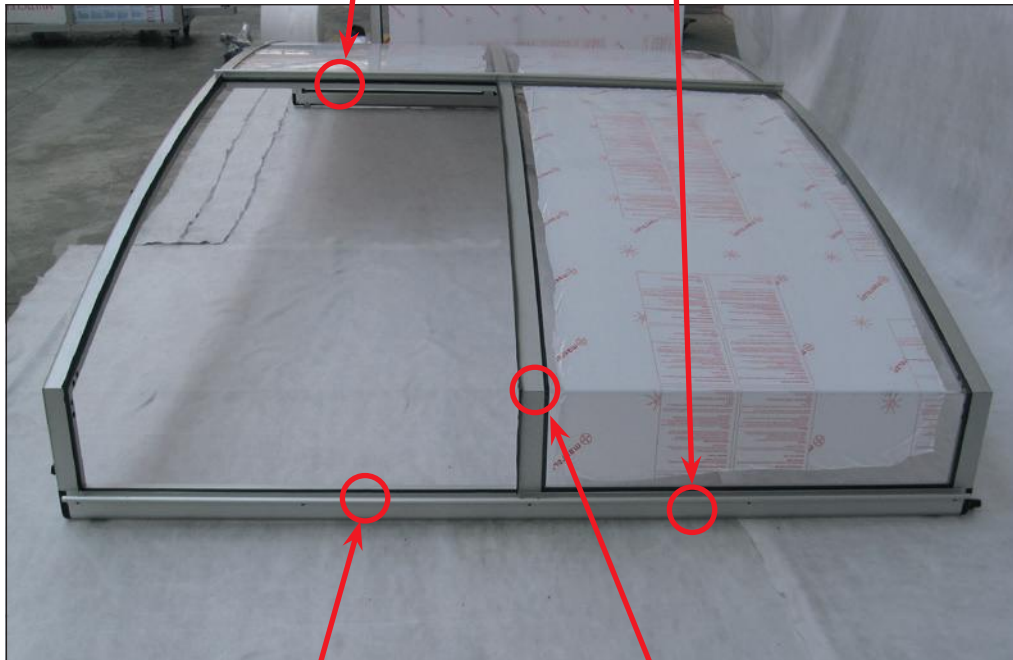
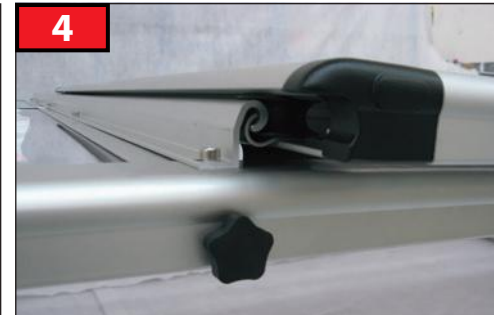

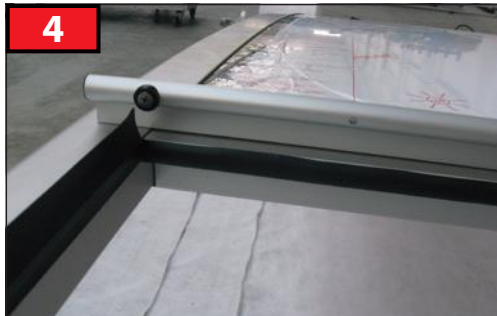

**PAGE 29**

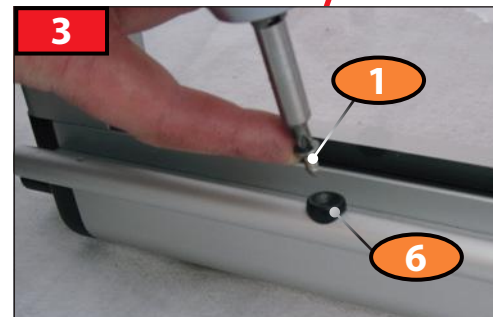
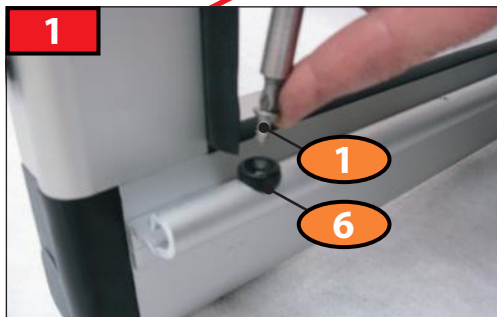



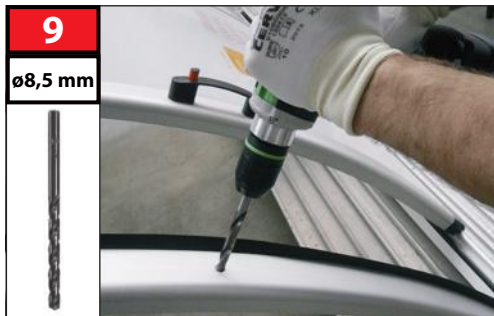
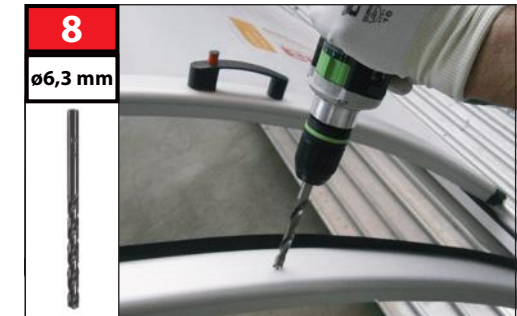
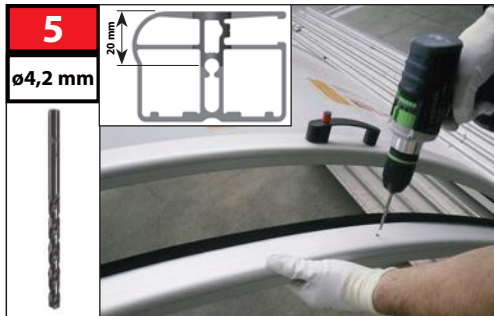
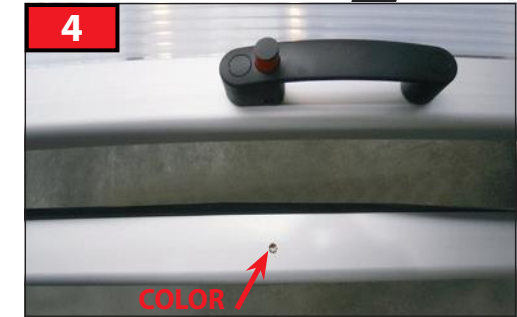

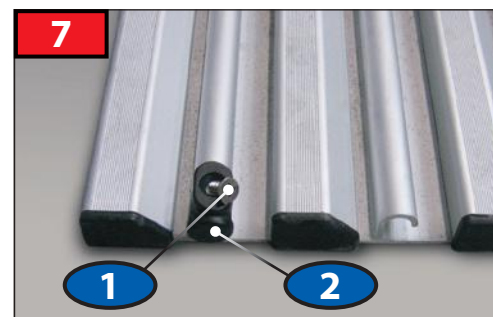
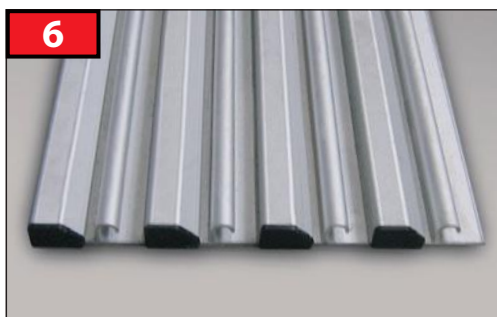
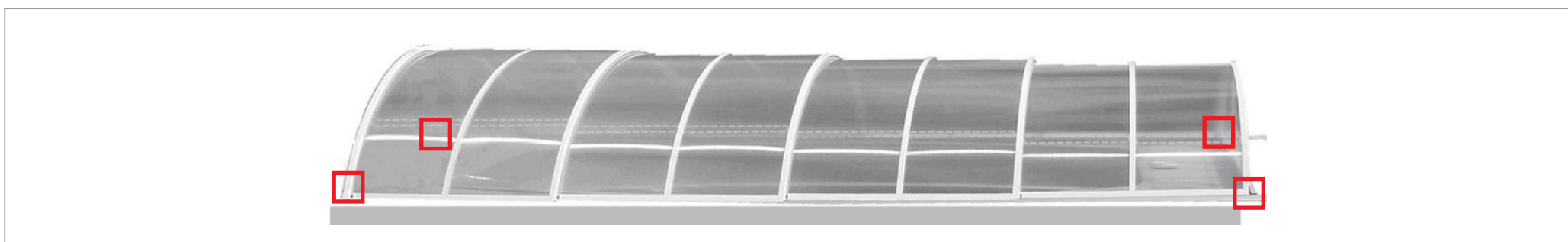
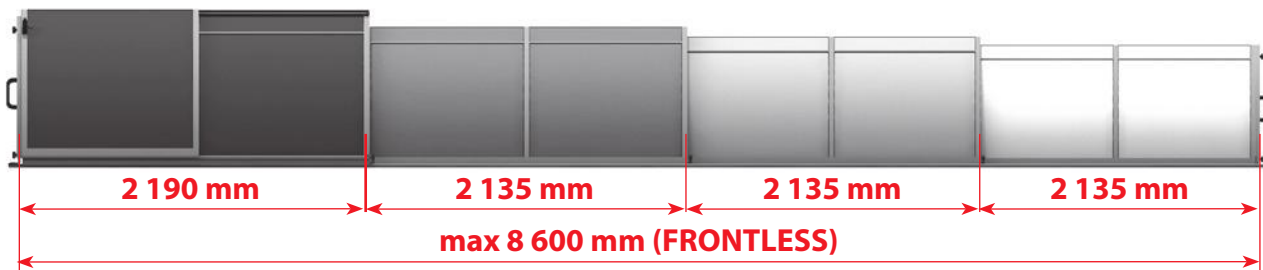





**CZ**

Dodavatel si vyhrazuje právo na změny a úpravy technických parametrů uváděných v tomto katalogu s ohledem na technický vývoj a zdokonalení výrobků a balení.  
Dodavatel si vyhrazuje právo na tiskové chyby a chyby v sazbě.

**DE**

Der Lieferant behält sich das Recht auf Änderungen und Anpassungen der technischen Parameter, die in diesem Katalog aufgeführt sind, mit Rücksicht auf die technische Entwicklung und Verbesserung der Produkte und Verpackung vor. Der Lieferant behält sich das Recht auf Druckfehler und Fehler im Satz vor.

**EN**

The supplier reserves the right for modifications and adaptations of the technical parameters stated in this catalogue, considering the technical development and upgrade of the products and packaging. The supplier reserves the right for print errors and typographical errors.

**ES**

El proveedor se reserva el derecho de hacer cambios y modificaciones técnicas de los parámetros que figuran en este catálogo, con respecto al desarrollo técnico mejorando los productos y embalajes. El proveedor se reserva también el derecho a errores de impresión y composición.

**FR**

Le fabricant se réserve le droit de modifier les paramètres techniques cités dans ce manuel en considération du développement technique et de l'amélioration des produits et de leur emballage. Le fabricant se réserve le droit des fautes d'impression et de composition.

**HU**

Gyártó fenntartja jogát a katalógusban feltüntetett műszaki paraméterek változtatására a termékek és csomagolás technikai fejlesztése és tökéletesítése szerint.  
Szállító: a szállító fenntartja jogát a nyomtatási és szedési hibákra.

**IT**

Il fornitore si riserva il diritto di effettuare modifiche e correzioni ai parametri tecnici riportati nel presente catalogo per migliorare e perfezionare dal punto di vista tecnico i prodotti e gli imballaggi. Il fornitore non esclude inoltre l'eventuale presenza di errori di stampa e di impaginazione.

**PL**

Dostawca zastrzega sobie prawo do zmian oraz dostosowania parametrów technicznych podanych w niniejszym katalogu z uwzględnieniem rozwoju technicznego i udoskonalania produktów oraz opakowań. Dostawca zastrzega sobie prawo do błędów druku oraz typograficznych.

**PT**

O provedor reserva-se o direito a efectuar alterações e adaptações de parâmetros técnicos mencionados neste catálogo, tendo em consideração o avanço técnico e melhorias de produtos e embalagens. O provedor reserva-se o direito a cometer erros de impressora e de edição.

**RO**

Furnizorul își rezervă dreptul de a modifica și schimba parametrii tehnici menționați în acest catalog cu privire la evoluția tehnică și perfecționarea produselor și a ambalării. Furnizorul își rezervă dreptul la greșelile de tipar și greșelile privind tarifele.

**RU**

Поставщик оставляет за собой право на изменение и исправление технических параметров продукции указанной в этом каталоге, с учетом технического развития, а усовершенствования изделий и его упаковки. Поставщик оставляет за собой право на опечатку в тексте и в ценах.