

Casablanca Infinity B Evo 2016

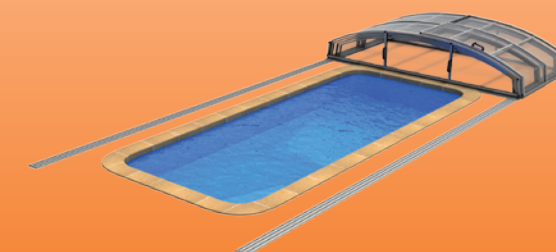

REVIZE: 2. 11. 2016

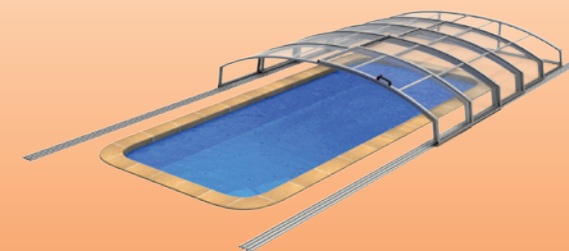
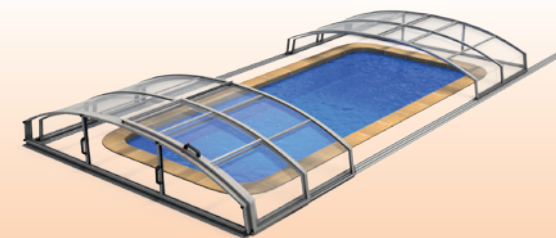
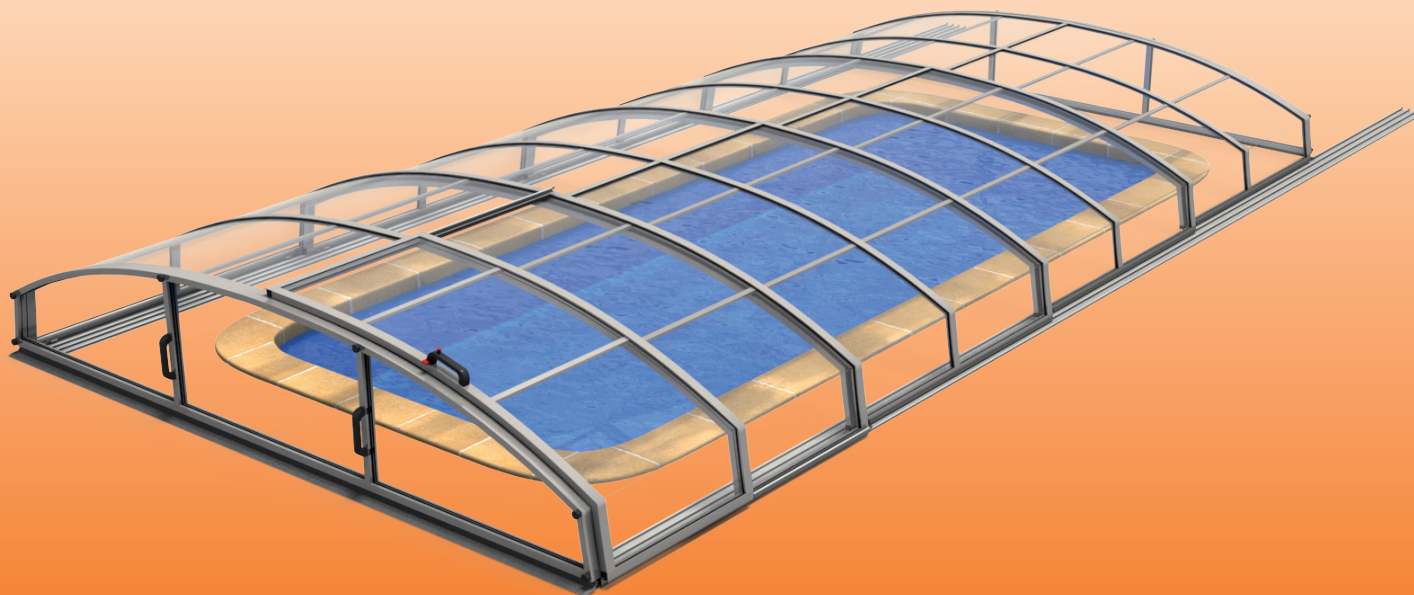
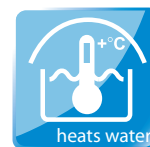

BG
 Покрилки за басейни: нова конструкция
 За повече информация: АНКОР - ИФ П 90-300
 За повече информация: ИФ П 90-300
 За повече информация: ИФ П 90-300

DE
 Schwimmabdeckungen für Pool: neue Konstruktion
 Für weitere Informationen: ANCOR - IF P 90-300
 Für weitere Informationen: IF P 90-300
 Für weitere Informationen: IF P 90-300

ES
 Cubiertas de piscinas: nueva forma
 Cubiertas de piscinas: nueva forma
 Cubiertas de piscinas: nueva forma

FR
 Niveaux de piscines: nouvelle forme
 Niveau de piscine: nouvelle forme
 Niveau de piscine: nouvelle forme

HU
 Medencefedélzetek: új formák
 Medencefedélzetek: új formák
 Medencefedélzetek: új formák

CN
 游泳池 遮阳棚
 游泳池 遮阳棚
 游泳池 遮阳棚

LT
 Šiluminė vandens baseinų konstrukcija
 Šiluminė vandens baseinų konstrukcija
 Šiluminė vandens baseinų konstrukcija

PL
 Zadaszki basenów: nowa konstrukcja
 Zadaszki basenów: nowa konstrukcja
 Zadaszki basenów: nowa konstrukcja

RU
 Покрышки для бассейнов: новая конструкция
 Покрышки для бассейнов: новая конструкция
 Покрышки для бассейнов: новая конструкция

SL
 Nadstrešnice za bazenove: nova konstrukcija
 Nadstrešnice za bazenove: nova konstrukcija
 Nadstrešnice za bazenove: nova konstrukcija

CZ
 Střešní krycí zařízení: nová konstrukce
 Střešní krycí zařízení: nová konstrukce
 Střešní krycí zařízení: nová konstrukce

DK
 Bassinoverdækning: ny konstruktion
 Bassinoverdækning: ny konstruktion
 Bassinoverdækning: ny konstruktion

EE
 Basiniikatted: uus konstruktsioon
 Basiniikatted: uus konstruktsioon
 Basiniikatted: uus konstruktsioon

GB
 The swimming pool enclosure: new design
 The swimming pool enclosure: new design
 The swimming pool enclosure: new design

HR
 Nadstrešnice bazena: nova konstrukcija
 Nadstrešnice bazena: nova konstrukcija
 Nadstrešnice bazena: nova konstrukcija

IT
 Coperture per piscine: nuova struttura
 Coperture per piscine: nuova struttura
 Coperture per piscine: nuova struttura

LV
 Basēnu jumti: jauna konstrukcija
 Basēnu jumti: jauna konstrukcija
 Basēnu jumti: jauna konstrukcija

RO
 Acoperișurile pentru piscine: nouă structură
 Acoperișurile pentru piscine: nouă structură
 Acoperișurile pentru piscine: nouă structură

SE
 Pooltak: ny konstruktion
 Pooltak: ny konstruktion
 Pooltak: ny konstruktion

SK
 Střešní krycí zariadenia: nová konštrukcia
 Střešní krycí zariadenia: nová konštrukcia
 Střešní krycí zariadenia: nová konštrukcia

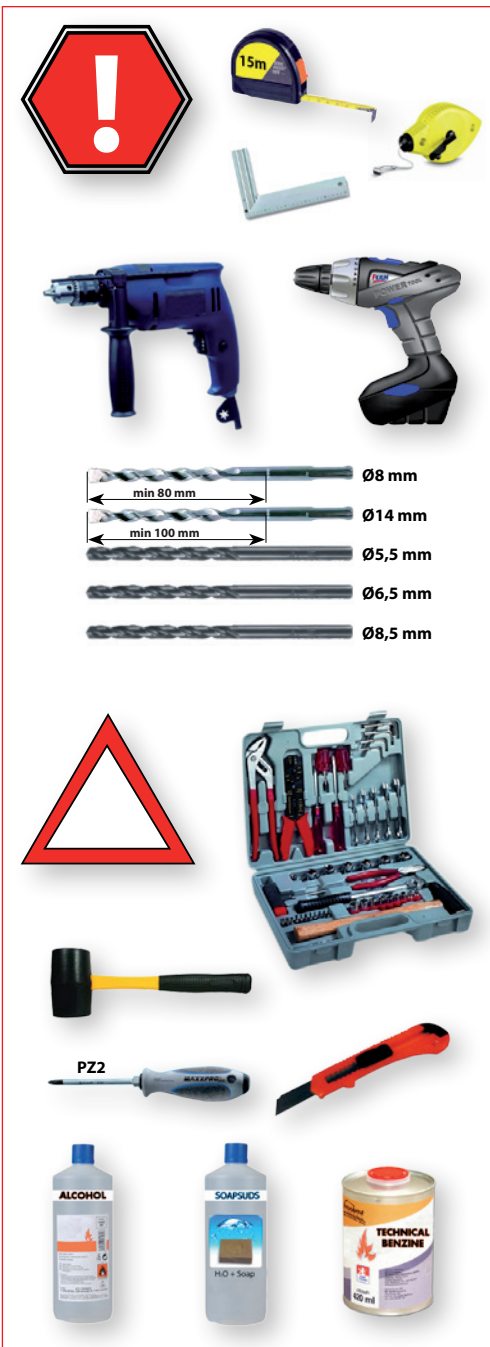

DIN 7982
4,8 x 13
16x
1

650.01.8811.2

16x
2

AN 9051
6,3 x 50
36x
3

007.20.1501.2

6x
4

DIN 7976
6,3 x 38
6x
5

007.02.0030.2

Ø4 x 10
114x
7

007.10.7012.2

Ø8 x 80
88x
9

007.02.0092.2

Ø4 x 14
6x
11

AN 9051
6,3 x 38
16x
13

Ø4,2
1x
14

1x
17

1x
18

097.02.0046.2

3x
19

097.02.0047.2

3x
20

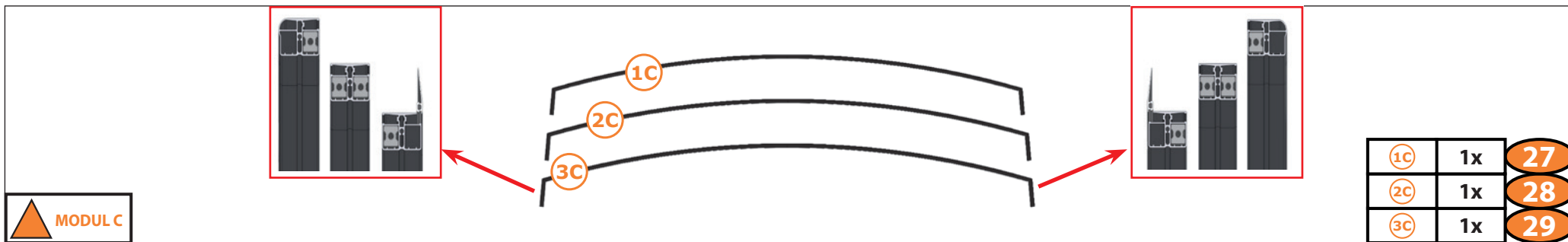
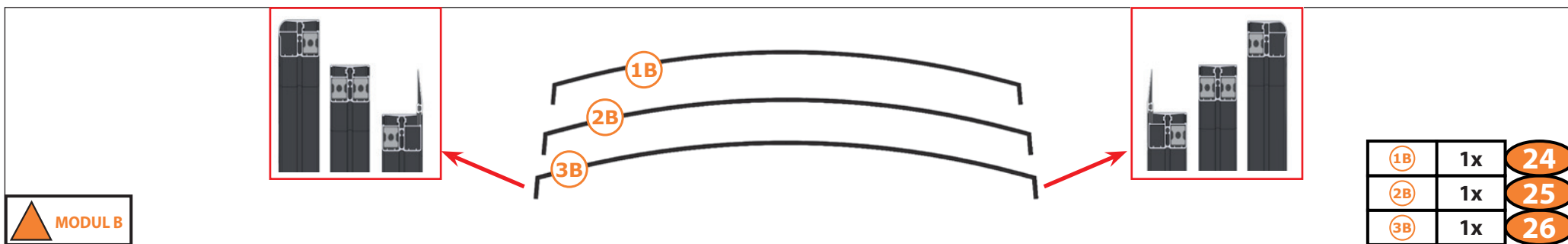
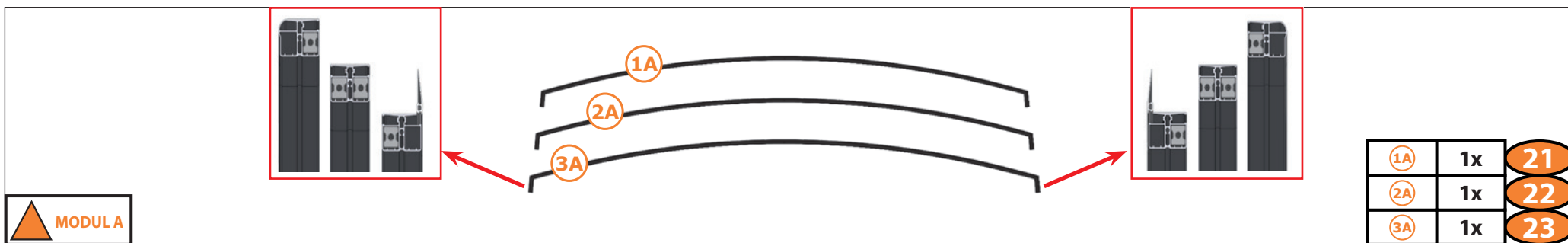
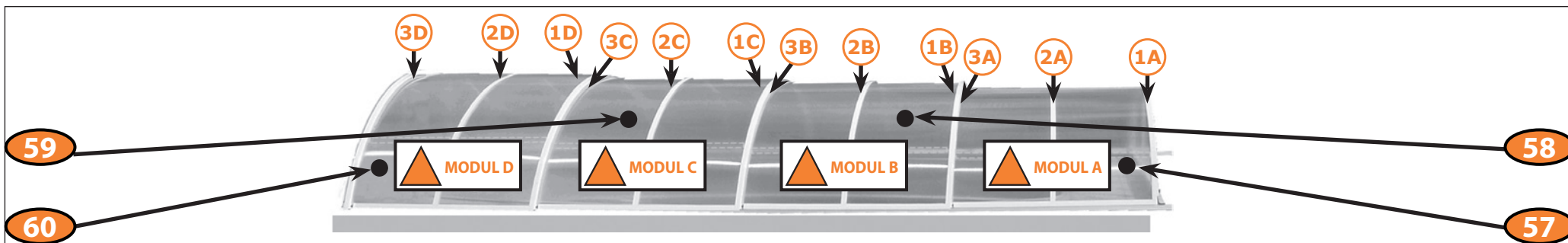



MODUL D

1D	1x	30
2D	1x	31
3D	1x	32

1041 mm
48x
36

8x
37



A
3230 mm
4x
41

B
2140 mm
4x
43

D
3230 mm
4x
47

D
3230 mm
16x
48



D
2140 mm
8x
49

MODUL D

1x
50

MODUL D

1x
51

MODUL B
MODUL C

2x
52



MODUL B
MODUL C

2x
53

MODUL A

1x
54

MODUL A

1x
55



MODUL A 4x
2469 x 1050 mm **57**

MODUL B 4x
2593 x 1050 mm **58**

MODUL C 4x
2725 x 1050 mm **59**

MODUL D 4x
2847 x 1050 mm **60**

1x
63

1x
64

ALBIXON
ALBIXON a.s.
Zbraslavská 55
Praha 5 - Malá Chuchle
159 00
www.albixongroup.cz
www.albixon.cz
CASABLANCA INFINITY

1x
66



Diagram showing the layout for Modul A. It includes a red box with a mouse cursor icon, a table of dimensions, and a label box.

2469 mm	8x
1050 mm	8x

92

MODUL A

Diagram showing the layout for Modul B. It includes a red box with a mouse cursor icon, a table of dimensions, and a label box.

2593 mm	8x
1050 mm	8x

93

MODUL B

Diagram showing the layout for Modul C. It includes a red box with a mouse cursor icon, a table of dimensions, and a label box.

2725 mm	8x
1050 mm	8x

94

MODUL C

Diagram showing the layout for Modul D. It includes a red box with a mouse cursor icon, a table of dimensions, and a label box.

2847 mm	8x
1050 mm	8x

96

MODUL D

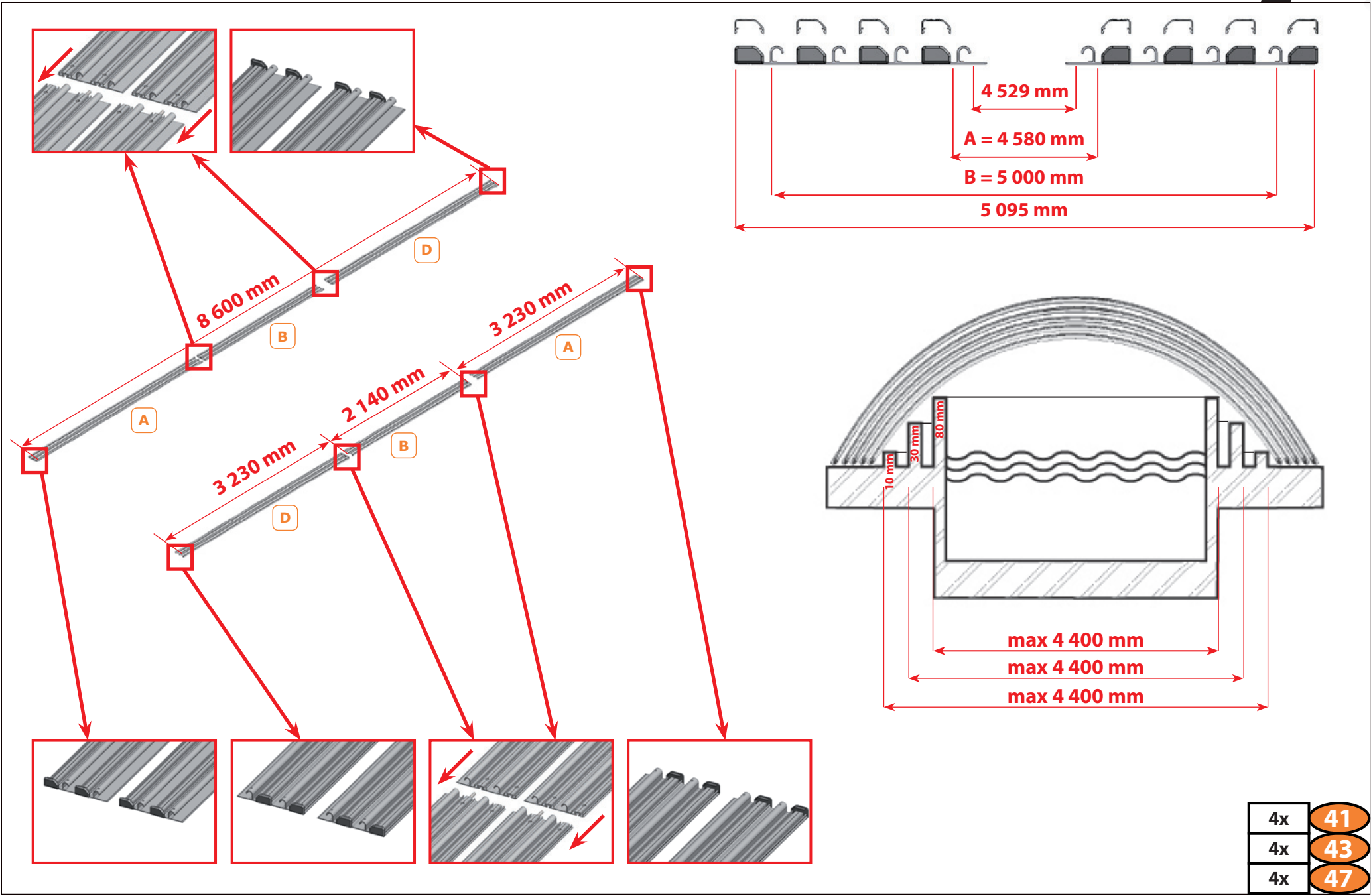

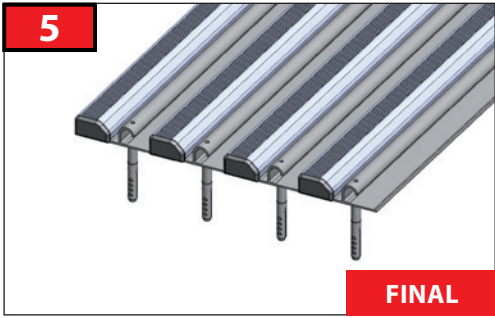
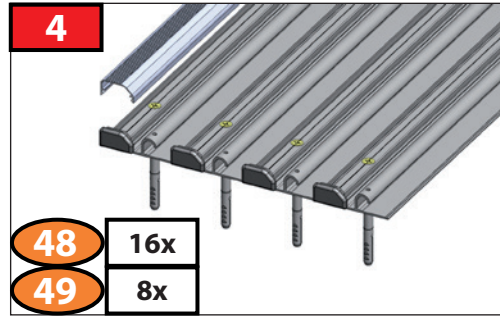
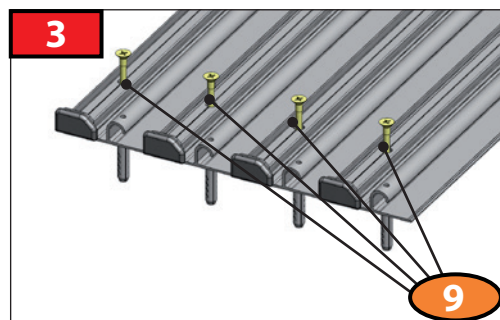
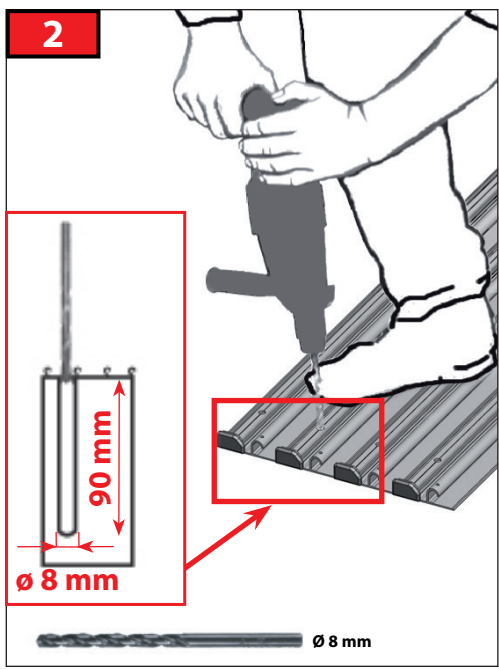
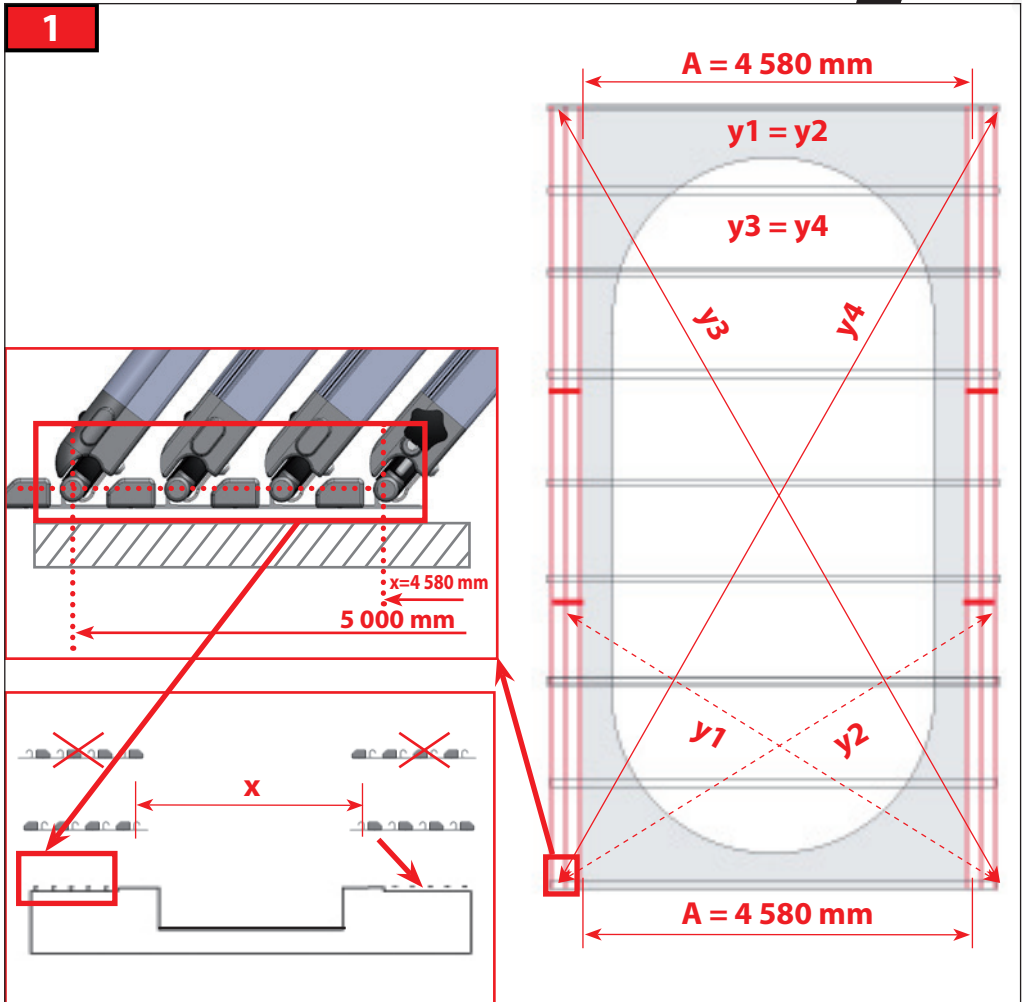
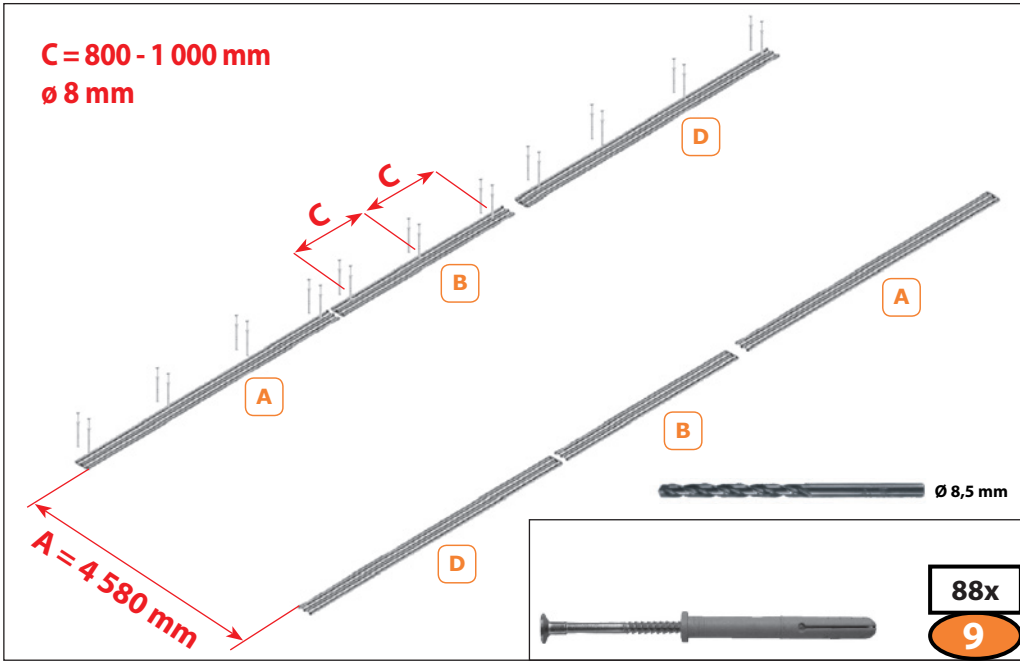

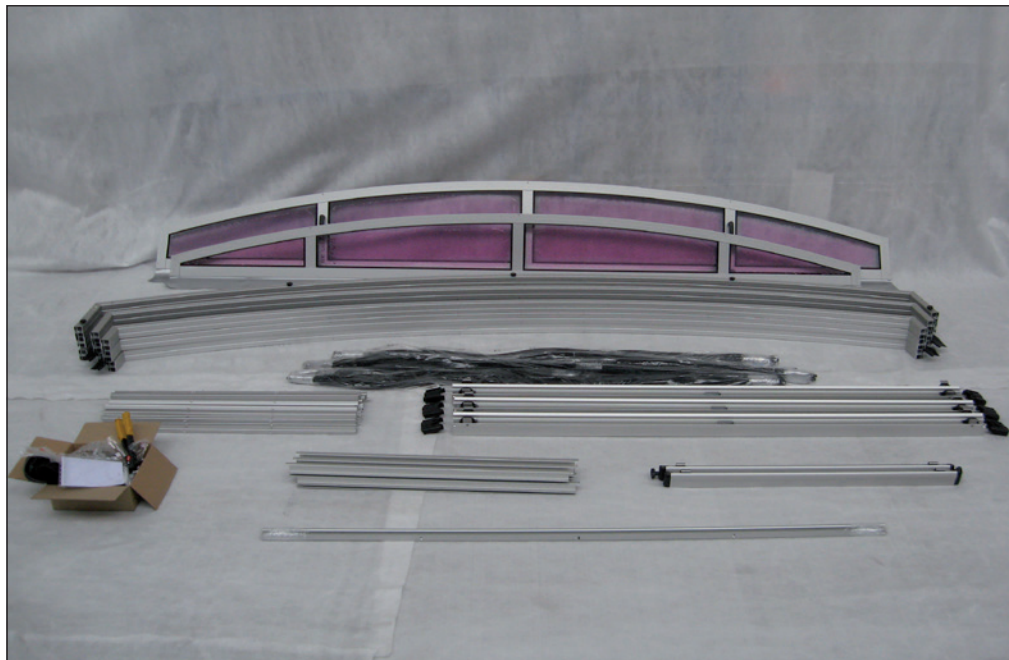

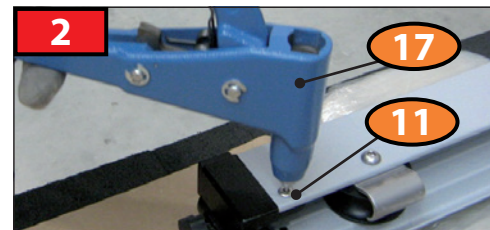
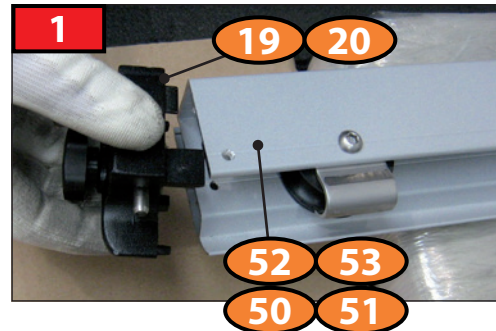
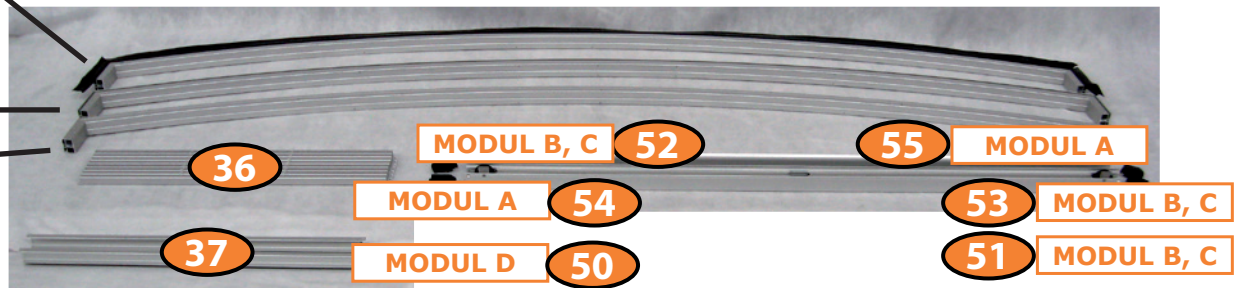
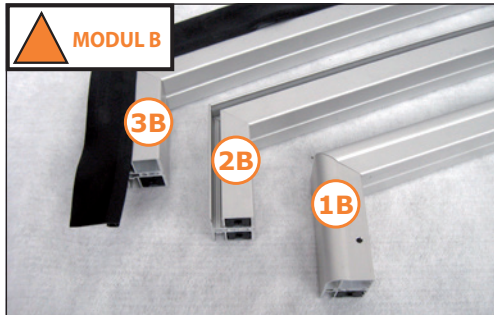
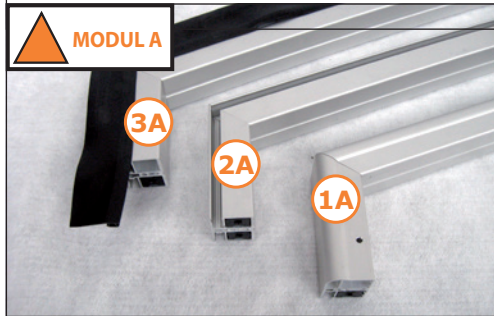
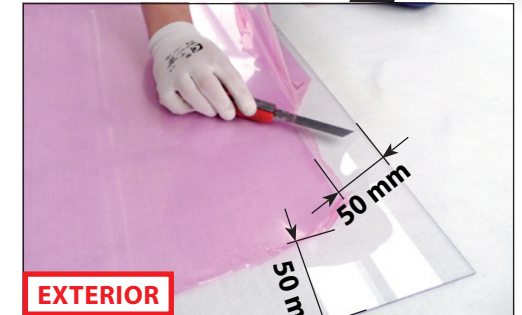
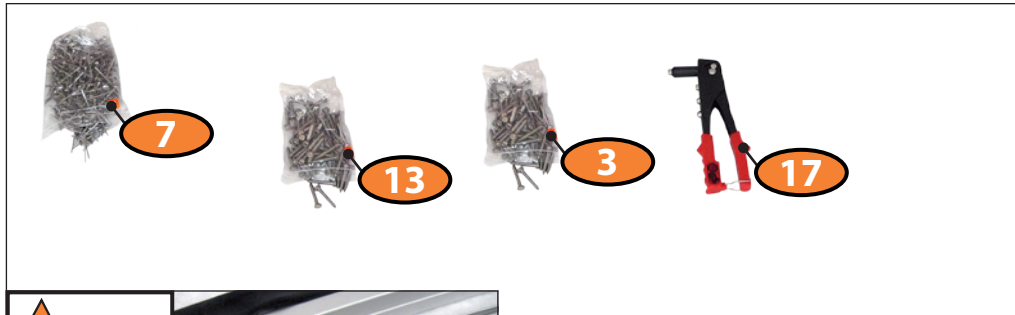

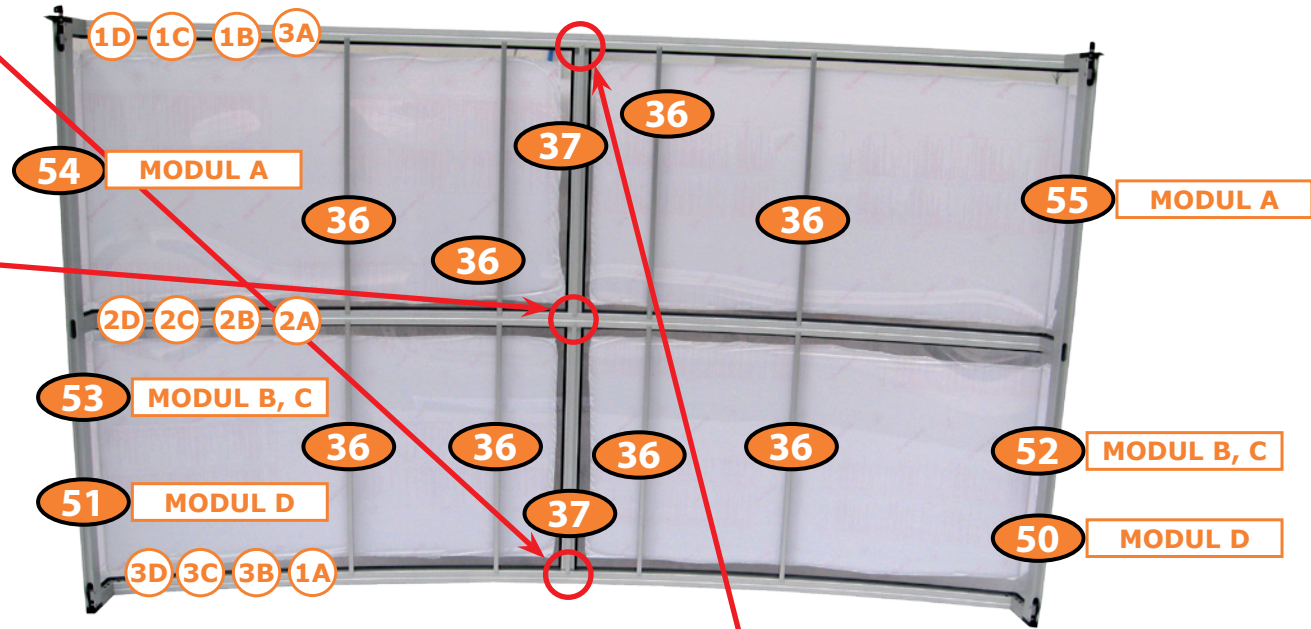
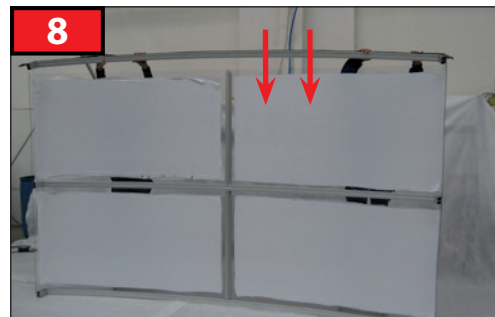
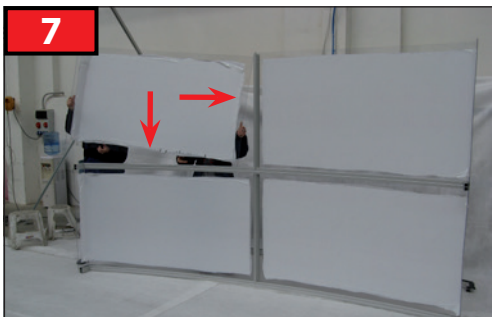
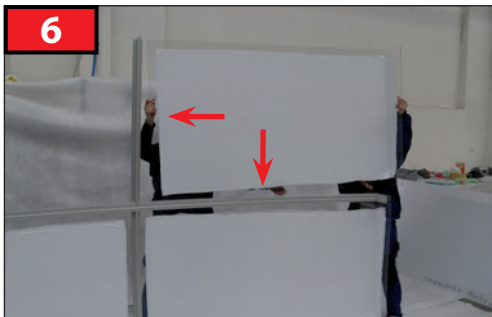
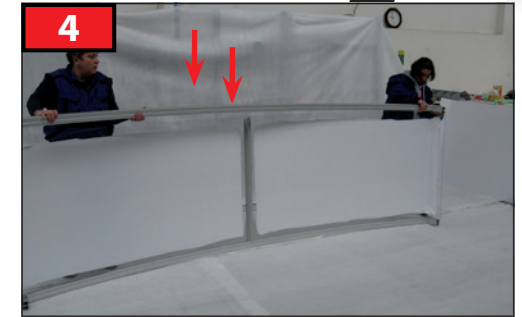
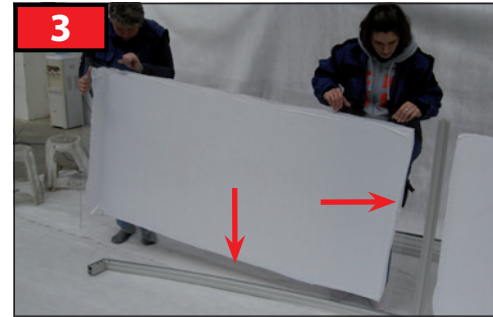
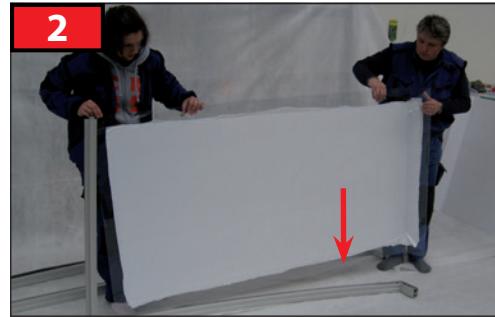

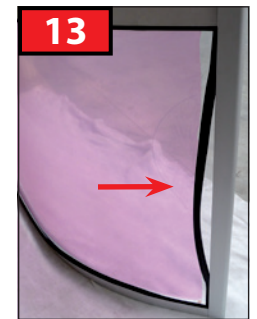
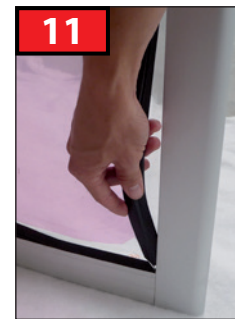
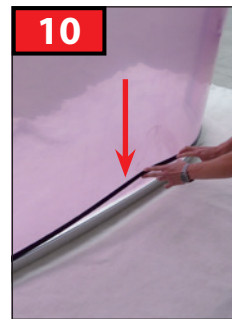
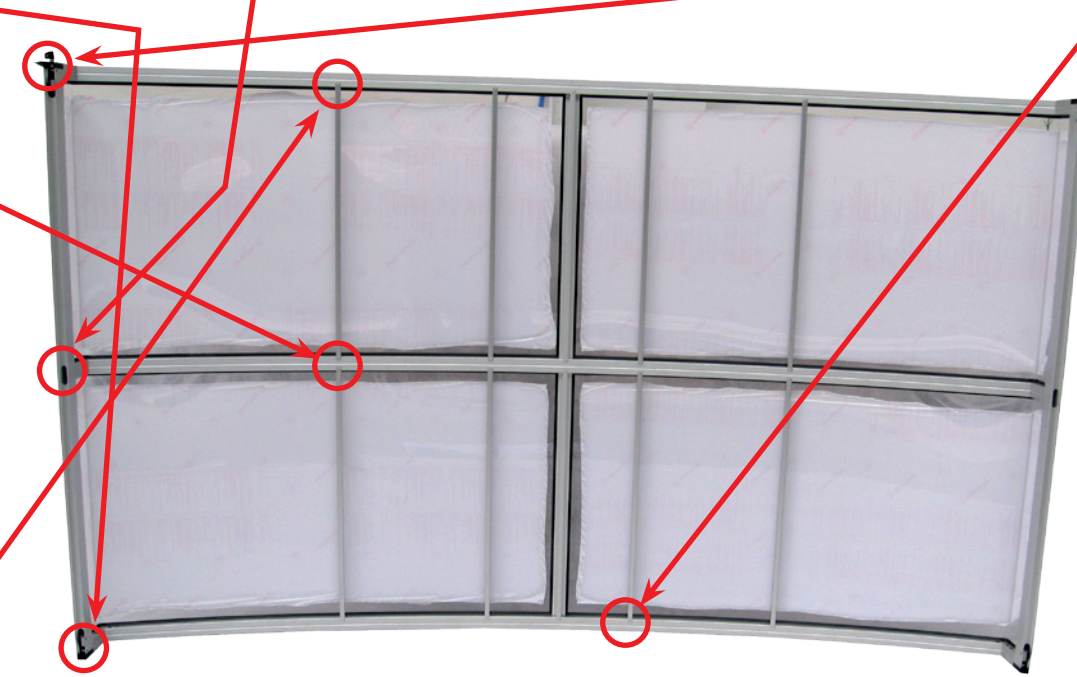
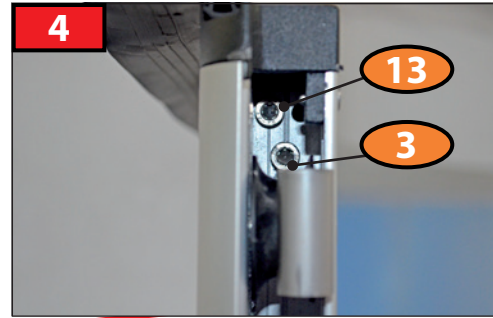
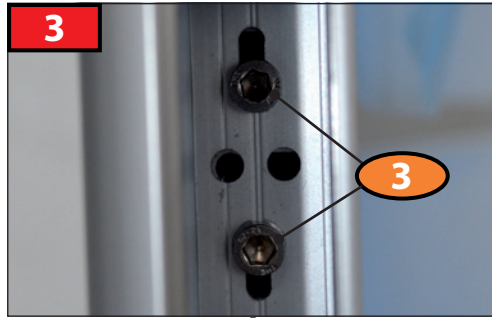
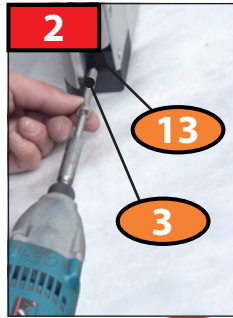

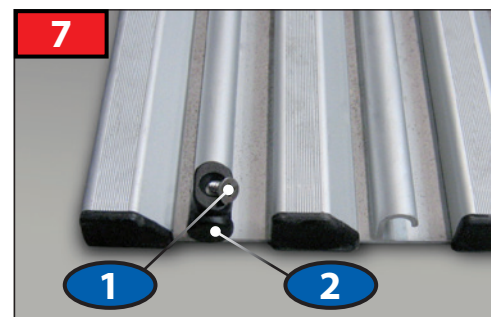
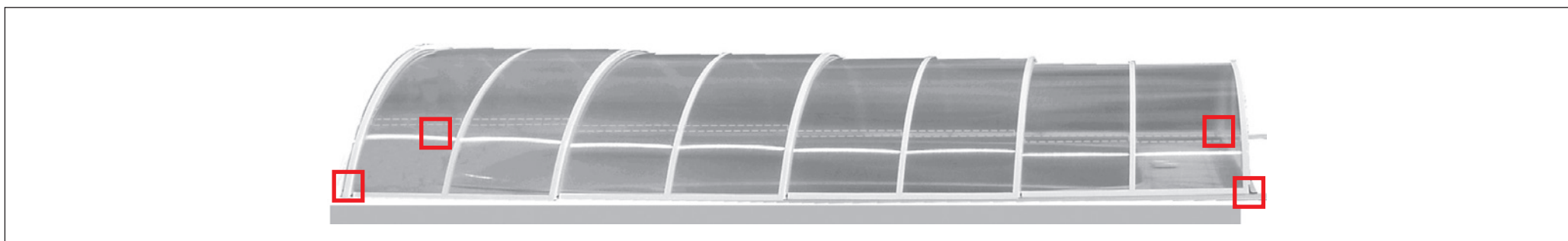
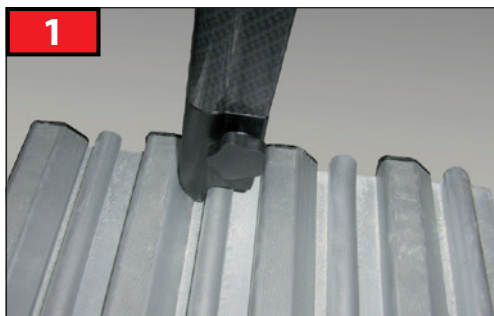
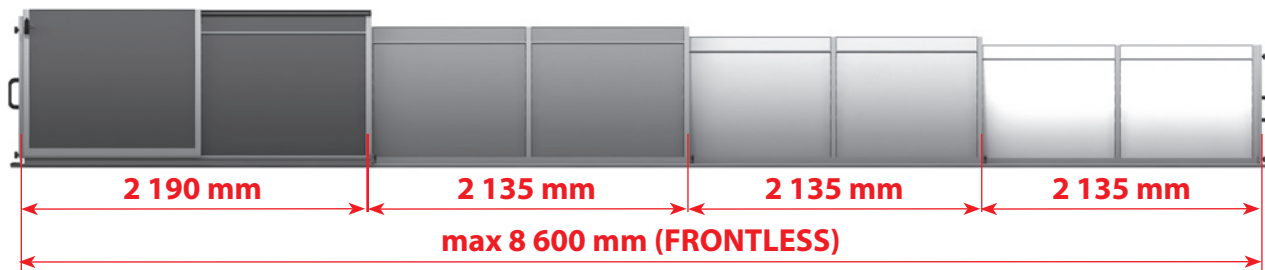

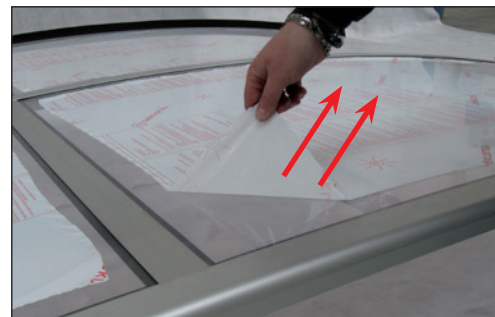
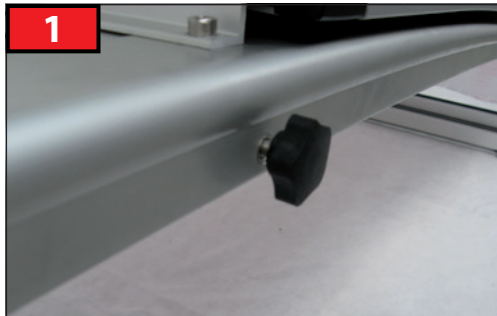

CZ

Dodavatel si vyhrazuje právo na změny a úpravy technických parametrů uváděných v tomto katalogu s ohledem na technický vývoj a zdokonalení výrobků a balení.
Dodavatel si vyhrazuje právo na tiskové chyby a chyby v sazbě.

DE

Der Lieferant behält sich das Recht auf Änderungen und Anpassungen der technischen Parameter, die in diesem Katalog aufgeführt sind, mit Rücksicht auf die technische Entwicklung und Verbesserung der Produkte und Verpackung vor. Der Lieferant behält sich das Recht auf Druckfehler und Fehler im Satz vor.

EN

The supplier reserves the right for modifications and adaptations of the technical parameters stated in this catalogue, considering the technical development and upgrade of the products and packaging. The supplier reserves the right for print errors and typographical errors.

ES

El proveedor se reserva el derecho de hacer cambios y modificaciones técnicas de los parámetros que figuran en este catálogo, con respecto al desarrollo técnico mejorando los productos y embalajes. El proveedor se reserva también el derecho a errores de impresión y composición.

FR

Le fabricant se réserve le droit de modifier les paramètres techniques cités dans ce manuel en considération du développement technique et de l'amélioration des produits et de leur emballage. Le fabricant se réserve le droit des fautes d'impression et de composition.

HU

Gyártó fenntartja jogát a katalógusban feltüntetett műszaki paraméterek változtatására a termékek és csomagolás technikai fejlesztése és tökéletesítése szerint.
Szállító: a szállító fenntartja jogát a nyomtatási és szedési hibákra.

IT

Il fornitore si riserva il diritto di effettuare modifiche e correzioni ai parametri tecnici riportati nel presente catalogo per migliorare e perfezionare dal punto di vista tecnico i prodotti e gli imballaggi. Il fornitore non esclude inoltre l'eventuale presenza di errori di stampa e di impaginazione.

PL

Dostawca zastrzega sobie prawo do zmian oraz dostosowania parametrów technicznych podanych w niniejszym katalogu z uwzględnieniem rozwoju technicznego i udoskonalania produktów oraz opakowań. Dostawca zastrzega sobie prawo do błędów druku oraz typograficznych.

PT

O provedor reserva-se o direito a efectuar alterações e adaptações de parâmetros técnicos mencionados neste catálogo, tendo em consideração o avanço técnico e melhorias de produtos e embalagens. O provedor reserva-se o direito a cometer erros de impressora e de edição.

RO

Furnizorul își rezervă dreptul de a modifica și schimba parametrii tehnici menționați în acest catalog cu privire la evoluția tehnică și perfecționarea produselor și a ambalării. Furnizorul își rezervă dreptul la greșelile de tipar și greșelile privind tarifele.

RU

Поставщик оставляет за собой право на изменение и исправление технических параметров продукции указанной в этом каталоге, с учетом технического развития, а усовершенствования изделий и его упаковки. Поставщик оставляет за собой право на опечатку в тексте и в ценах.