

Casablanca Infinity A 2016

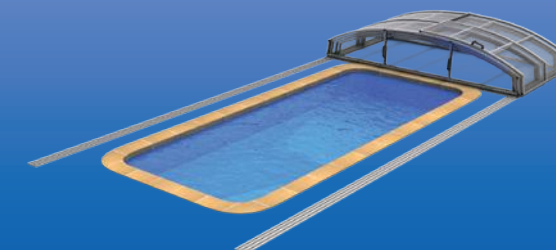

REVIZE: 2. 11. 2016

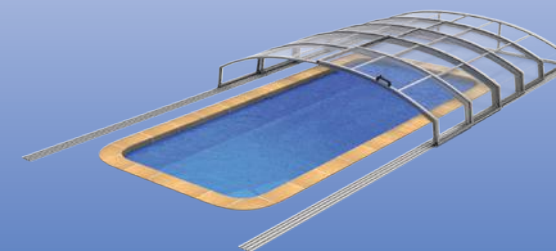
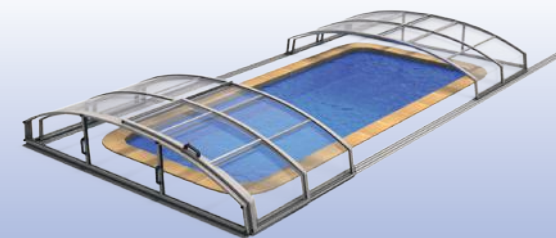
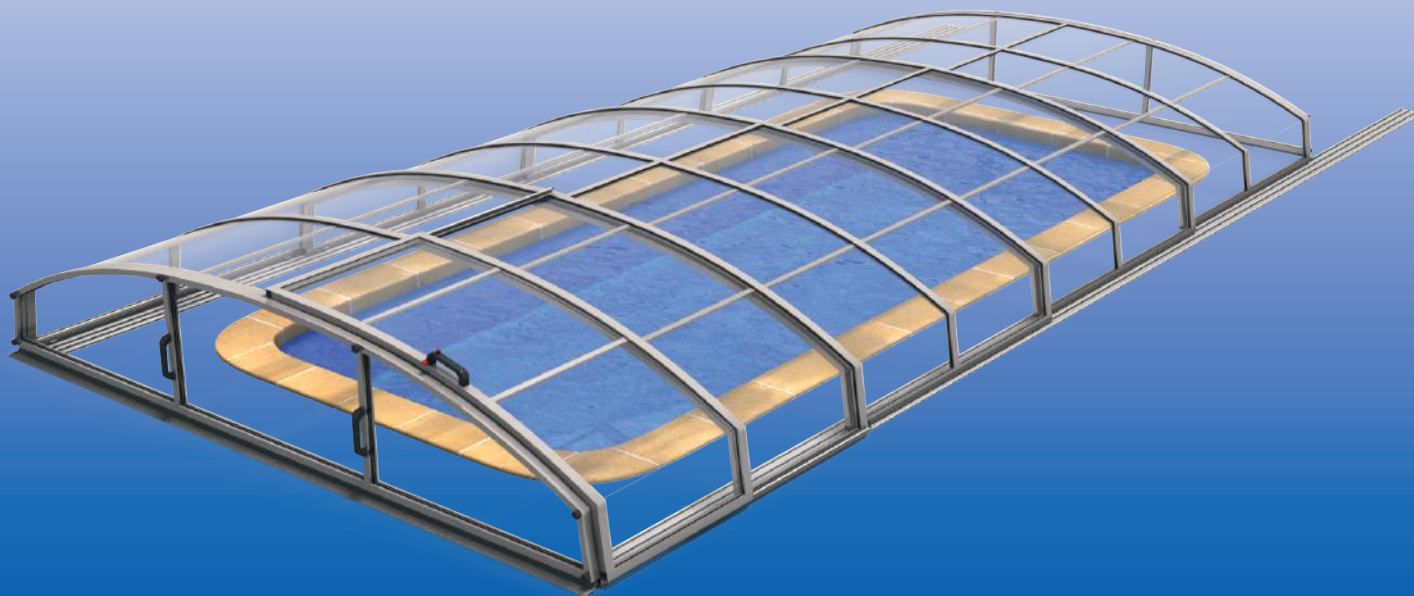
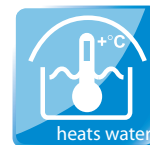

BG
 Тръгването на Casablanca Infinity A 2016 е разрешено в България.
 За повече информацията за условията на продажбата и гаранцията се обърнете към местните дилъри на Albixon в България.

DE
 Verkauf und Installation von Casablanca Infinity A 2016 ist in Deutschland erlaubt.
 Für weitere Informationen zu den Verkaufsbedingungen und der Garantie wenden Sie sich bitte an die regionalen Vertriebspartner von Albixon in Deutschland.

ES
 Casablanca Infinity A 2016 está autorizado para venderse e instalarse en España.
 Para más información sobre las condiciones de venta y la garantía, consulte a los distribuidores locales de Albixon en España.

FR
 Mise à disposition de Casablanca Infinity A 2016 est autorisée en France.
 Pour plus d'informations sur les conditions de vente et la garantie, contactez les distributeurs locaux de Albixon en France.

HU
 A Casablanca Infinity A 2016 eladó és telepíthető Magyarországon.
 További információkért forduljon a helyi Albixon partnerekhez.

CN
 Casablanca Infinity A 2016 可在中國銷售及安裝。
 欲知詳情，請洽當地 Albixon 經銷商。

LT
 Casablanca Infinity A 2016 yra leidžiama parduoti ir instaliuoti Lietuvoje.
 Dėl papildomos informacijos apie pardavimo sąlygas ir garantiją kreipkitės į vietinius Albixon partnerius.

PL
 Sprzedaż i montaż Casablanca Infinity A 2016 jest dozwolony w Polsce.
 Więcej informacji o warunkach sprzedaży i gwarancji uzyskasz u lokalnych partnerów Albixon w Polsce.

RU
 Продажа и установка Casablanca Infinity A 2016 разрешены в России.
 Для получения дополнительной информации о условиях продажи и гарантии обращайтесь к местным партнерам Albixon в России.

SL
 Prodaja in namestitveni del Casablanca Infinity A 2016 sta dovoljena v Sloveniji.
 Za več informacij o pogoje prodaje in garancije se obrnite na lokalne partnere Albixon v Sloveniji.

CZ
 Prodej a instalace Casablanca Infinity A 2016 je povoleno v České republice.
 Pro více informací o podmínkách prodeje a záruce se obraťte na místní partnery Albixon v České republice.

DK
 Salg og installation af Casablanca Infinity A 2016 er tilladt i Danmark.
 For yderligere oplysninger om salgsbetingelser og garanti, kontakt de lokale partnere for Albixon i Danmark.

EE
 Casablanca Infinity A 2016 on lubatud müüa ja paigaldada Eestis.
 Täpsemate informatsioonide saamiseks pöörduge kohalike Albixon partnerite poole.

GB
 The Casablanca Infinity A 2016 swimming pool enclosure is available for sale and installation in the United Kingdom.
 For more information on the terms of sale and warranty, contact your local Albixon partner.

HR
 Prodaja i instalacija Casablanca Infinity A 2016 je dopuštena u Hrvatskoj.
 Za više informacija o uvjetima prodaje i garanciji obratite se lokalnim partnerima Albixon u Hrvatskoj.

IT
 Vendita e installazione di Casablanca Infinity A 2016 è consentita in Italia.
 Per maggiori informazioni sulle condizioni di vendita e la garanzia, rivolgetevi ai partneri Albixon in Italia.

LV
 Casablanca Infinity A 2016 ir atļaujams pārdot un uzstādīt Latvijā.
 Par papildu informāciju par pārdošanas nosaukumiem un garantiju sazinieties ar vietējiem Albixon partneriem.

RO
 Vânzarea și instalarea Casablanca Infinity A 2016 este permisă în România.
 Pentru mai multe informații despre condițiile de vânzare și garanție, contactați partenerii locali Albixon din România.

SE
 Försäljning och installation av Casablanca Infinity A 2016 är tillåtet i Sverige.
 För ytterligare information om försäljningsvillkoren och garantin, kontakta de lokala Albixon-partnerna i Sverige.

SK
 Prodej a instalácia Casablanca Infinity A 2016 je povolená v Slovenskej republike.
 Pre ďalšie informácie o podmienkach predaja a záruky sa obráťte na miestnych partnerov Albixon v Slovenskej republike.

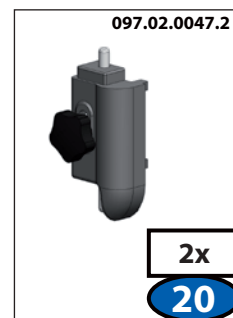
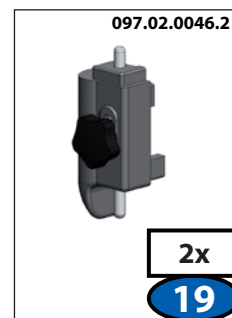
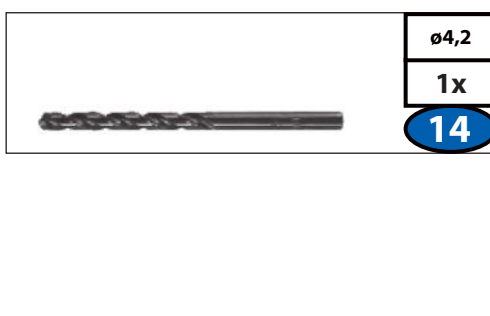
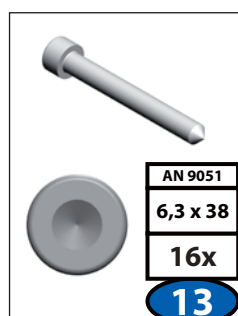
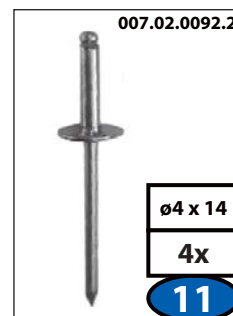
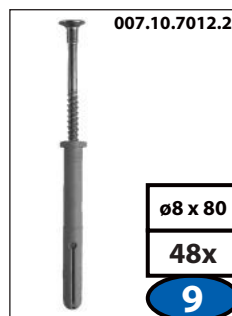
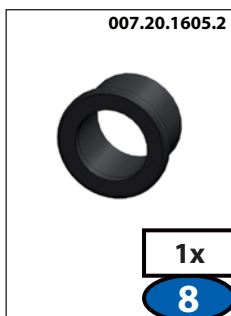
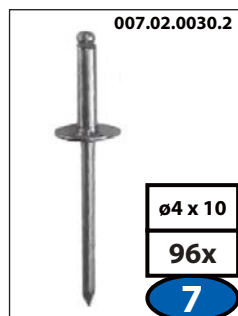
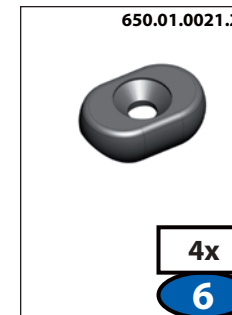
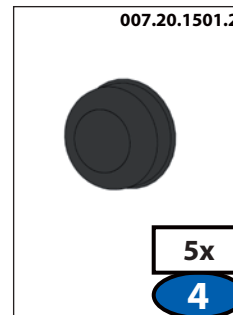
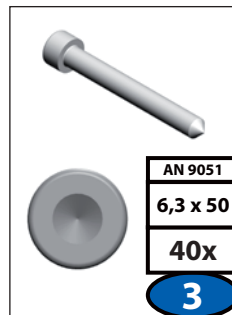
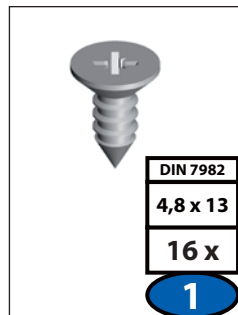
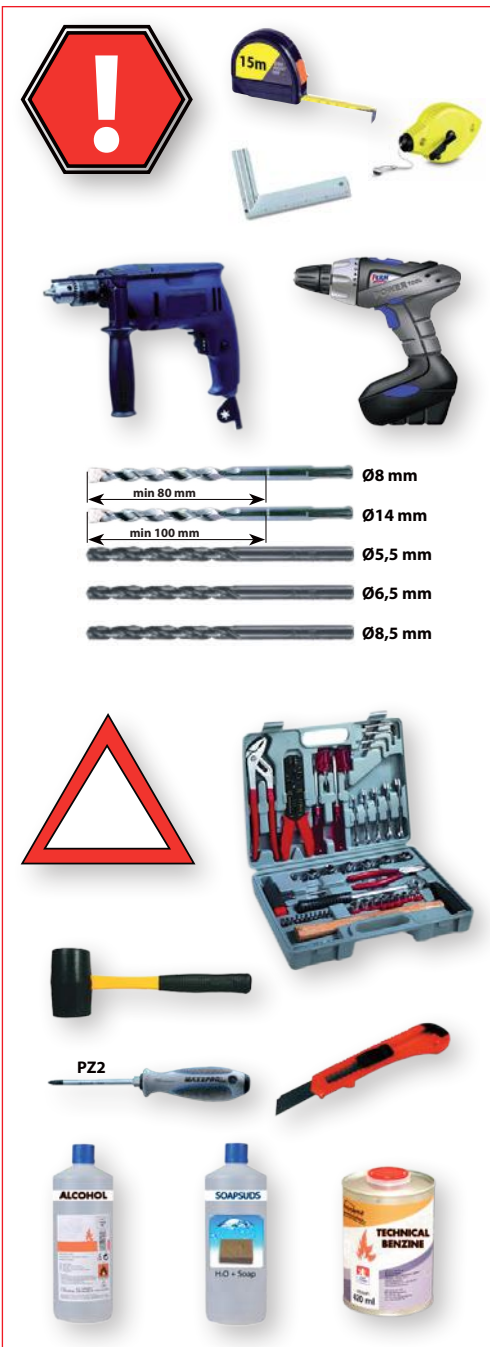

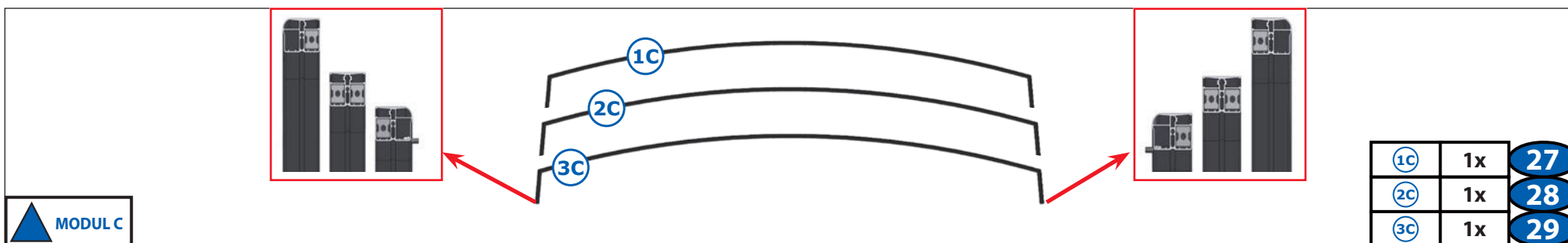
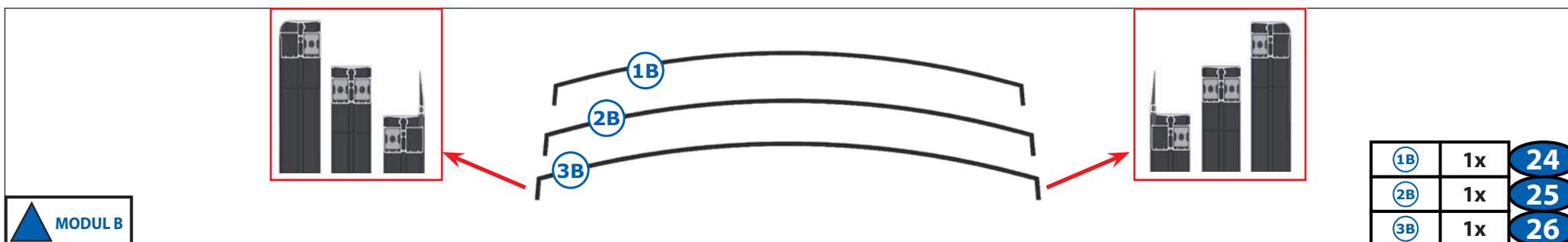
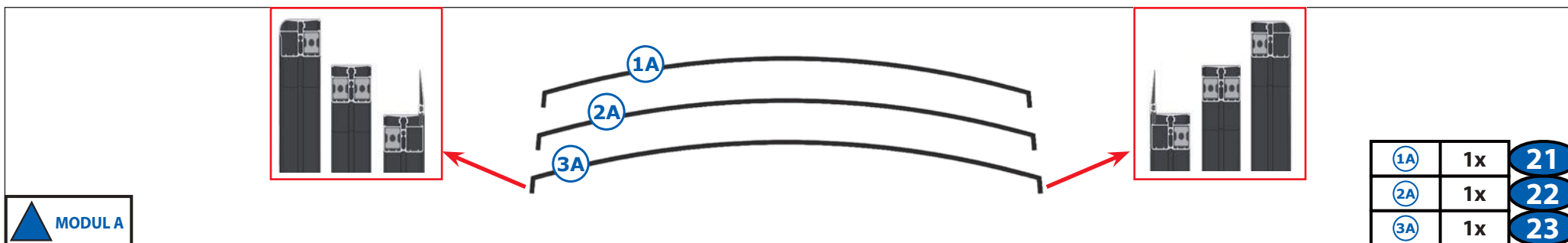
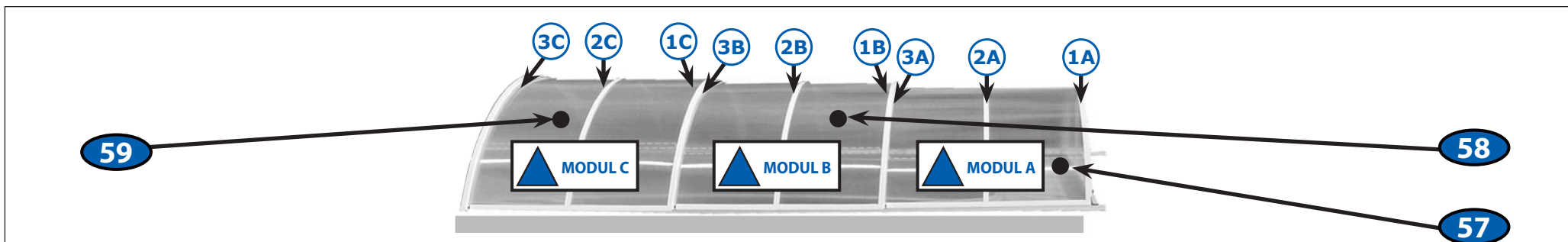



1041 mm
24x
36

4x
37

A
3230 mm
2x
40

D
3230 mm
2x
46



3230 mm
12x
48

MODUL C

1x
50

MODUL C

1x
51

MODUL B

1x
52

MODUL B

1x
53

MODUL A

1x
54

MODUL A

1x
55

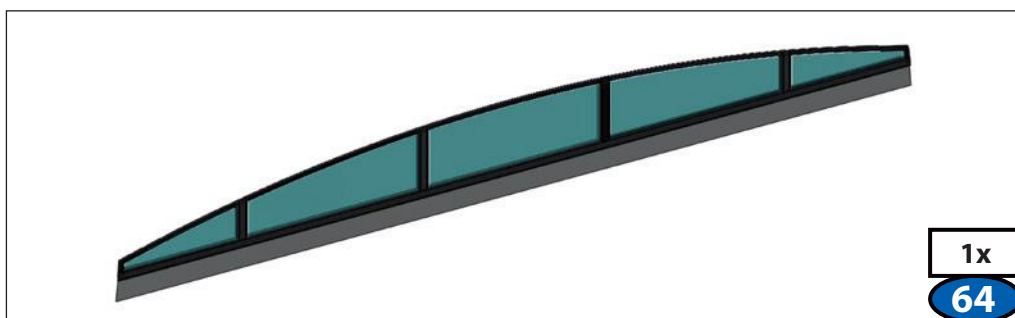
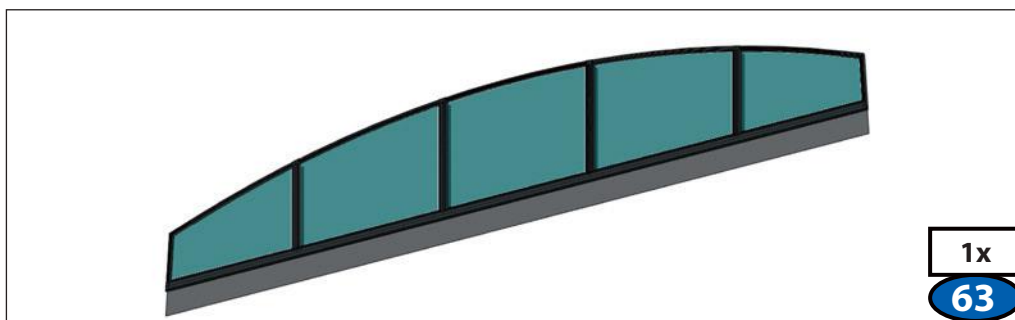
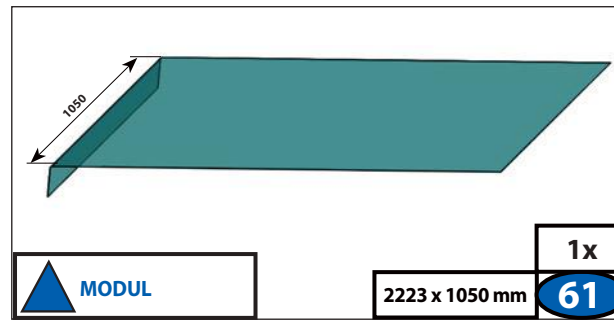
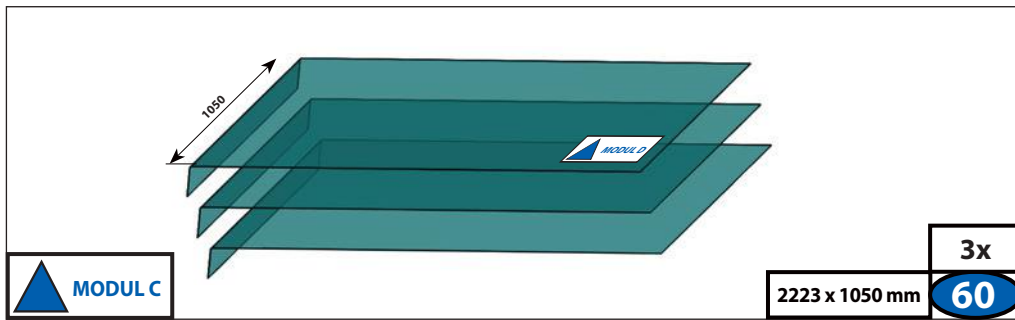
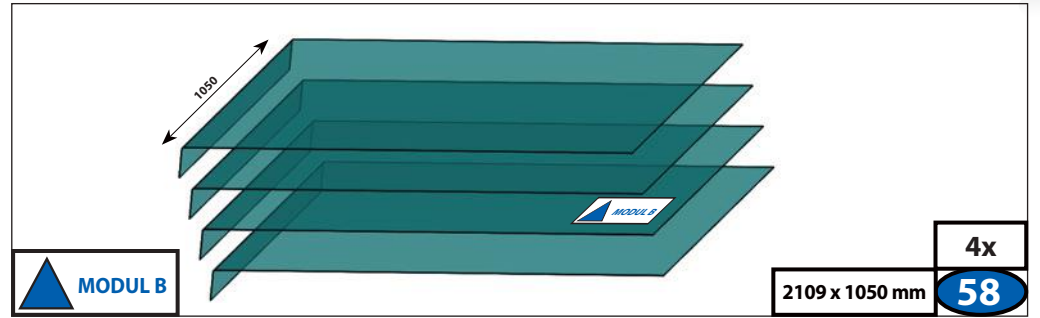
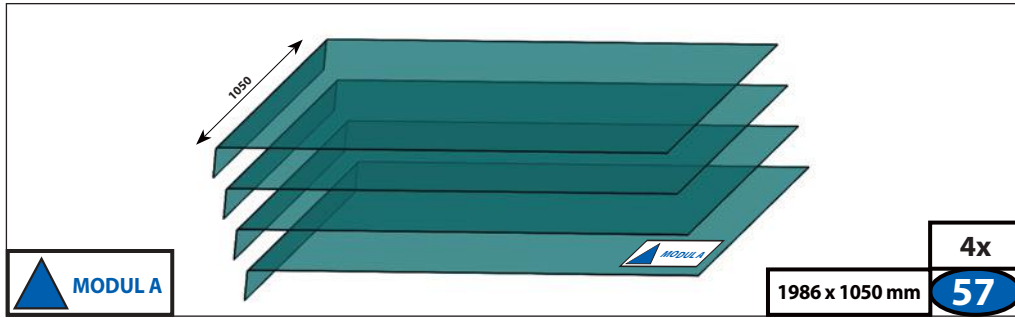

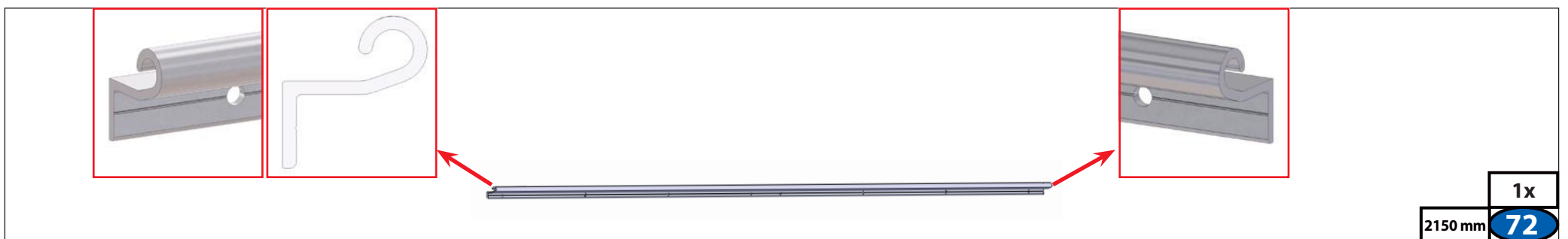
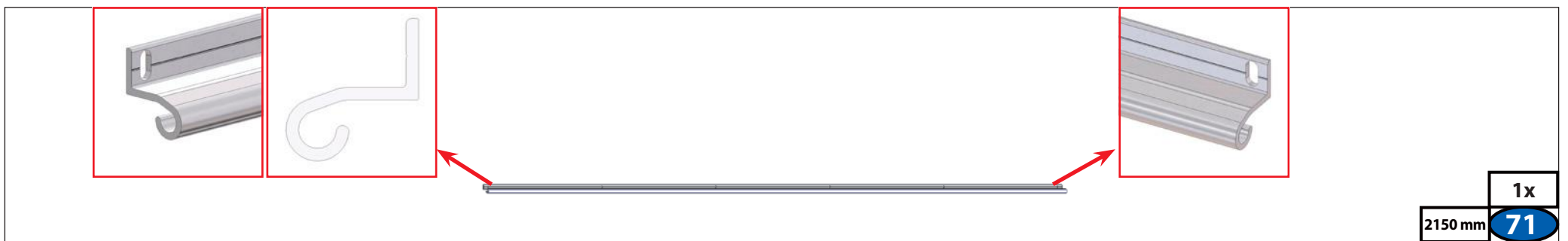
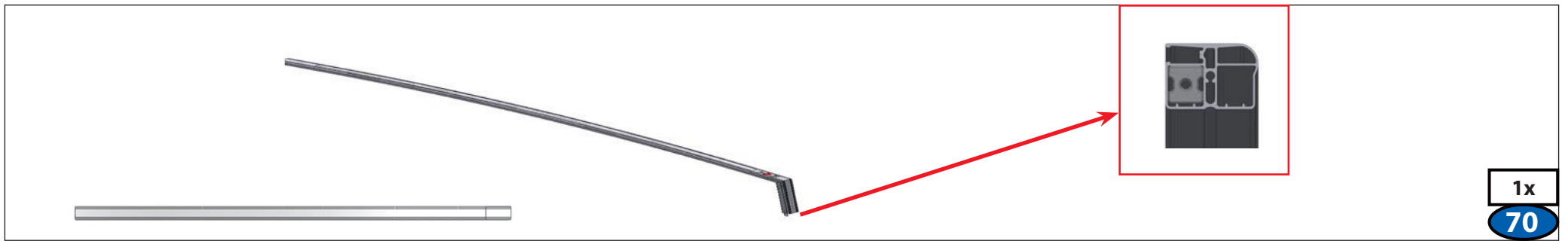
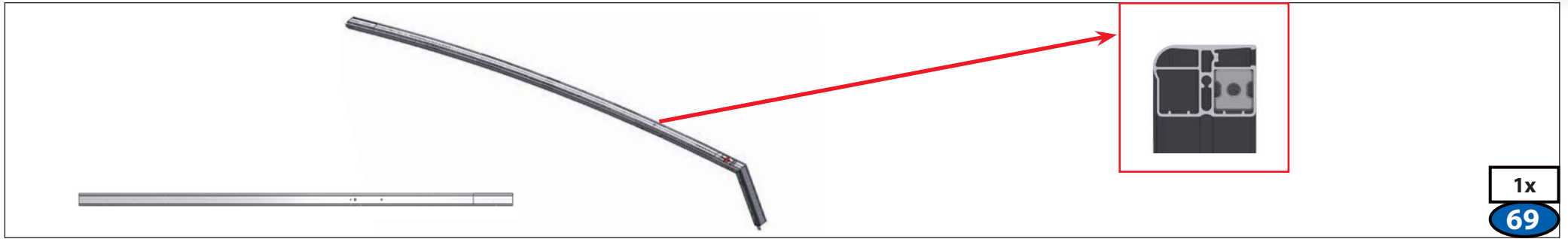

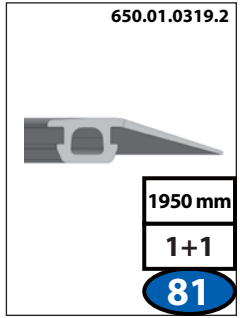
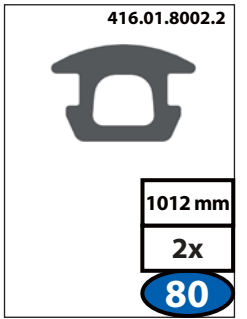
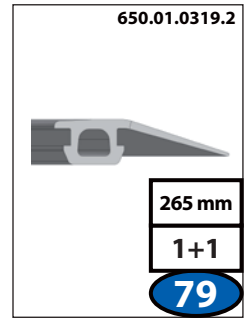
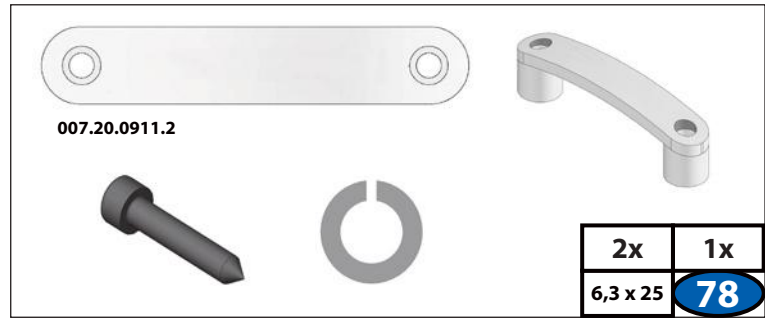
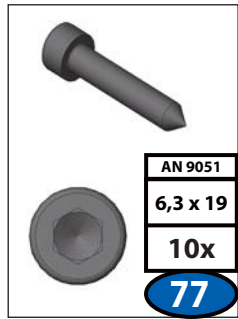
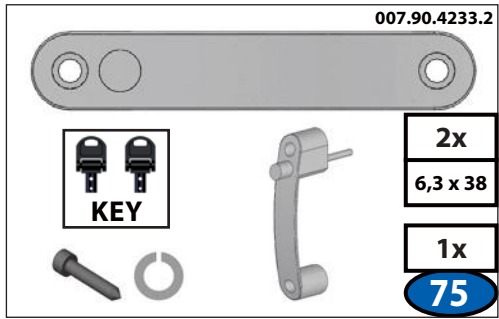
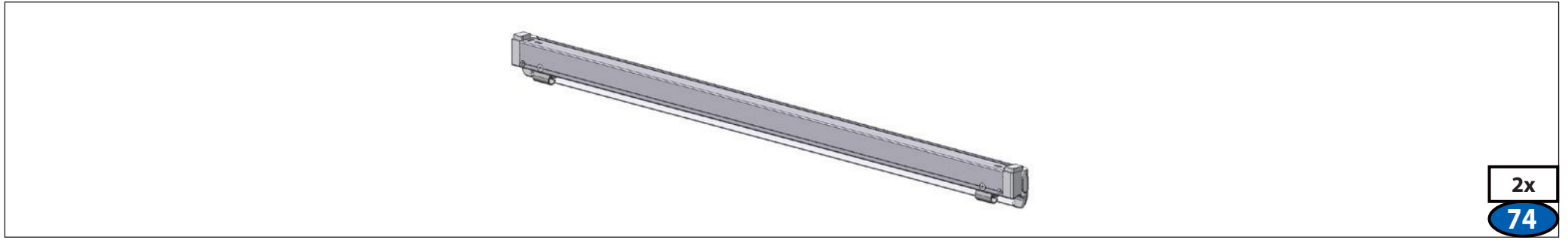
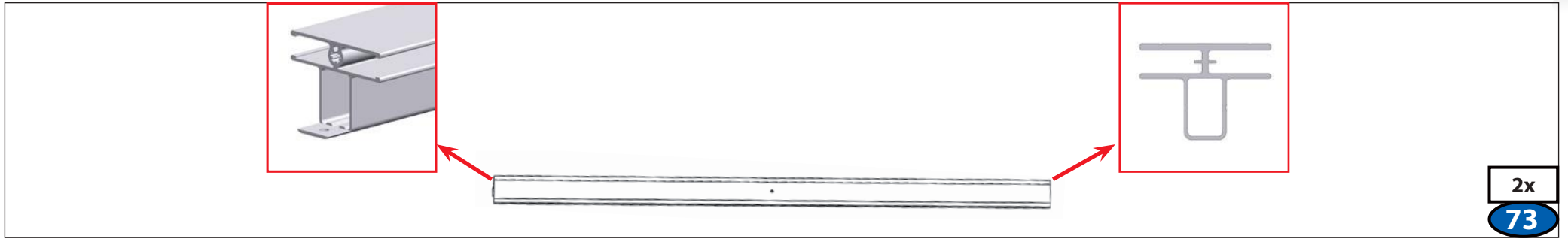



Diagram of Modul A showing dimensions and specifications.

1986 mm	8x
1050 mm	8x

92

Diagram of Modul B showing dimensions and specifications.

2109 mm	8x
1050 mm	8x

93

Diagram of Modul C showing dimensions and specifications.

2223 mm	8x
1050 mm	8x

96

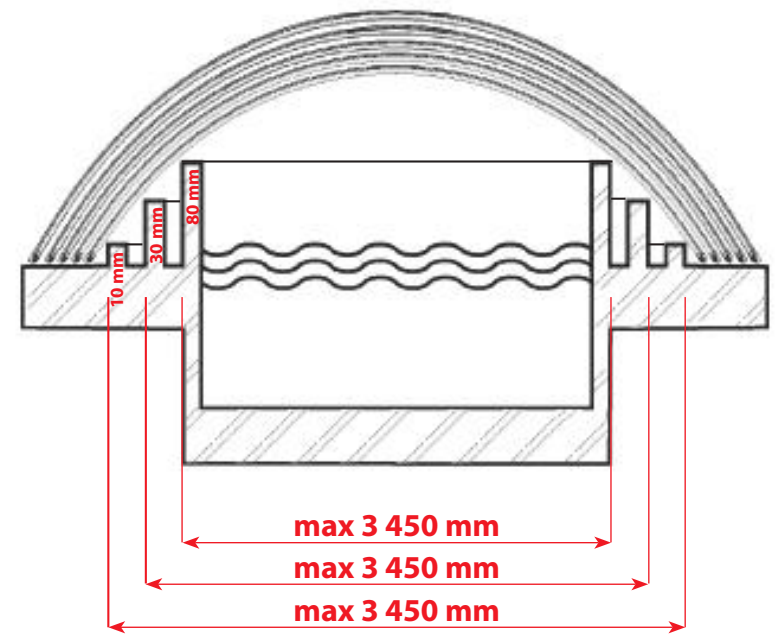
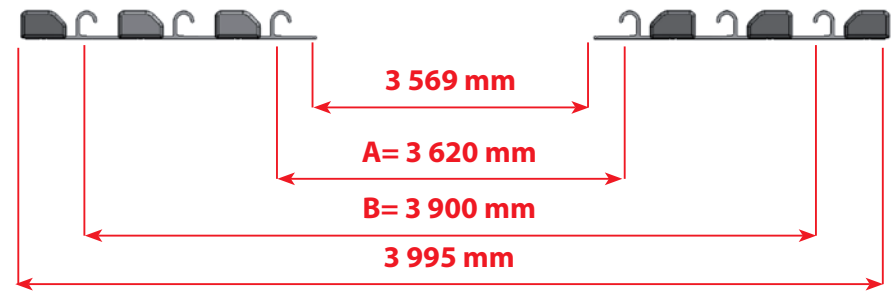
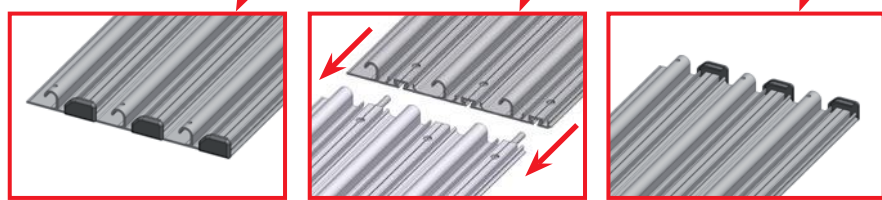
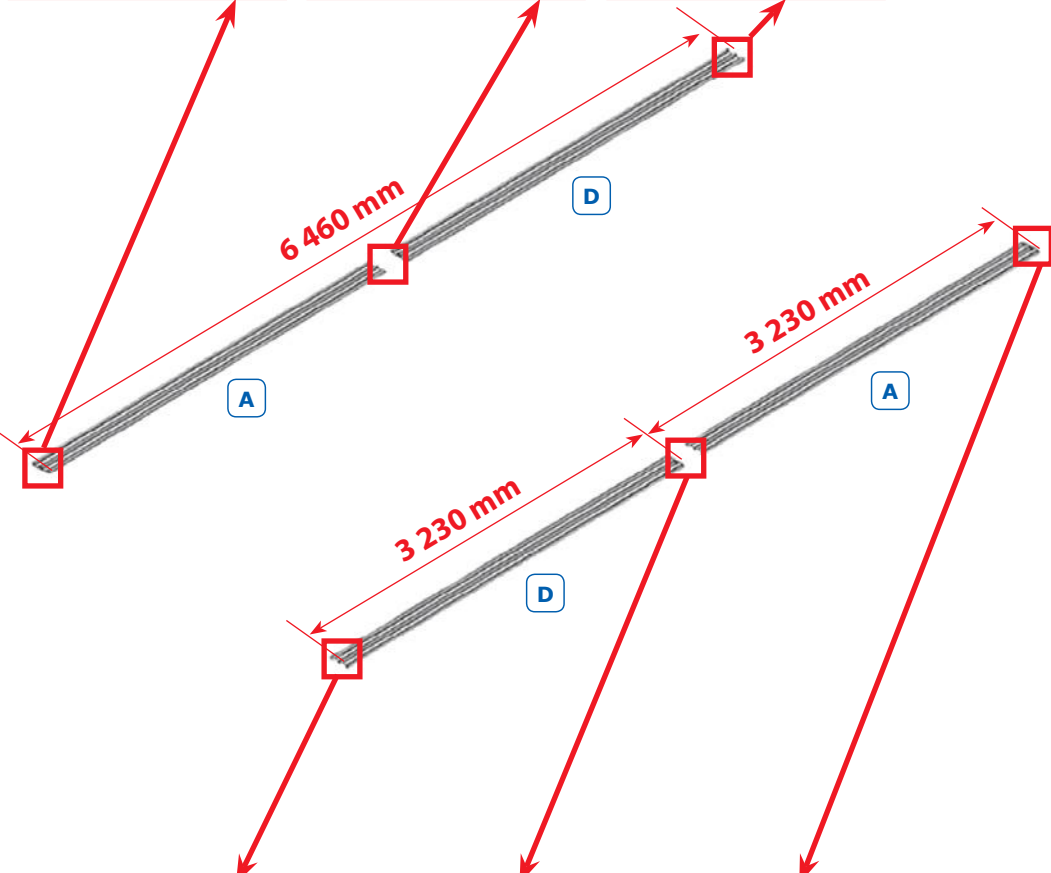
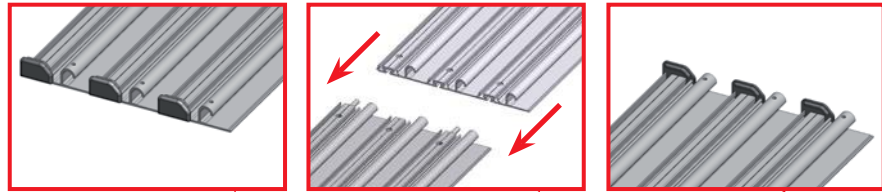

2x	41
2x	47

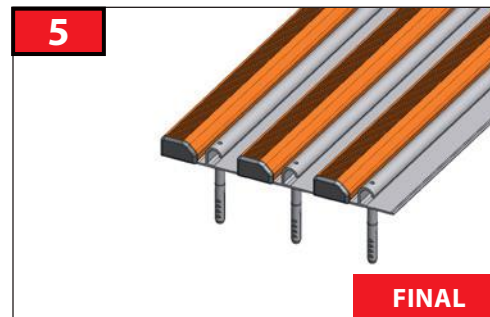
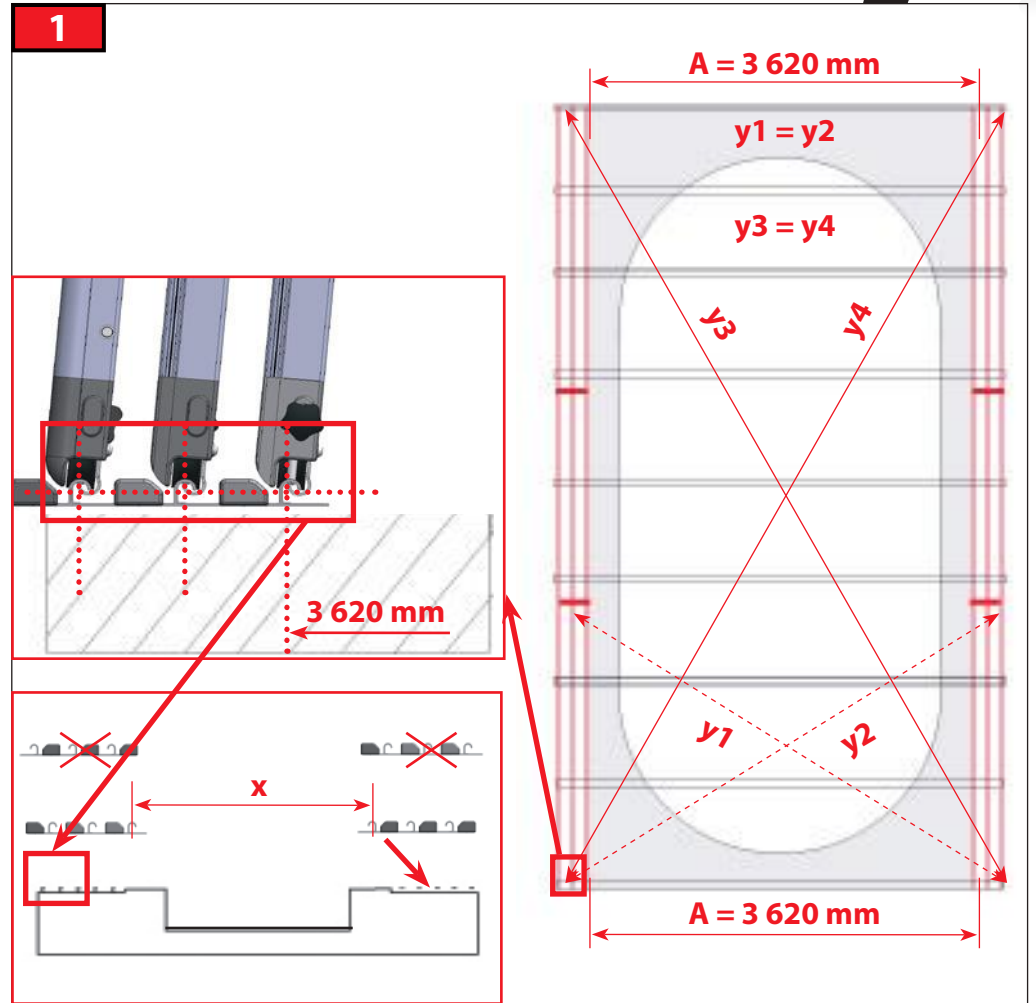
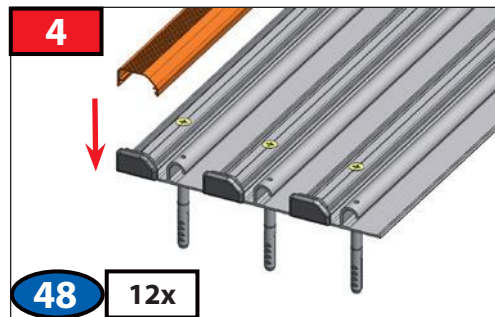
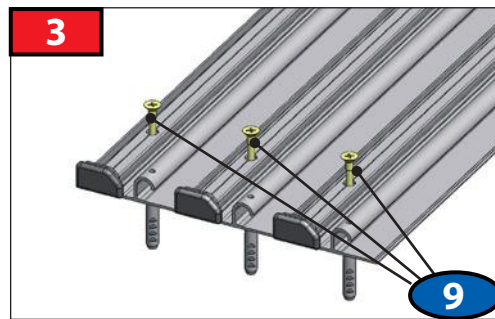
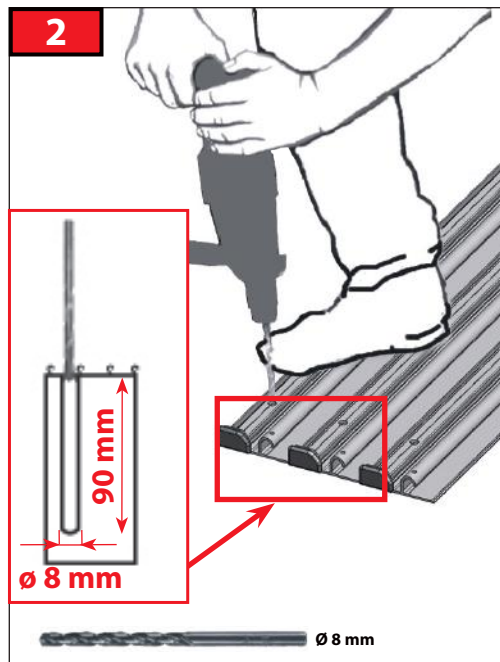
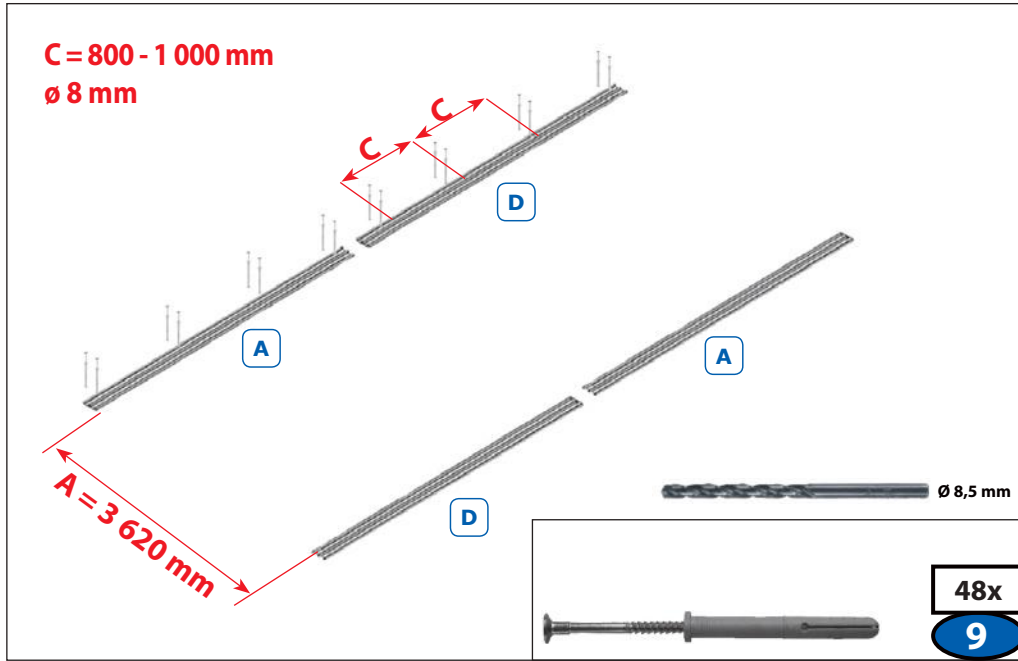

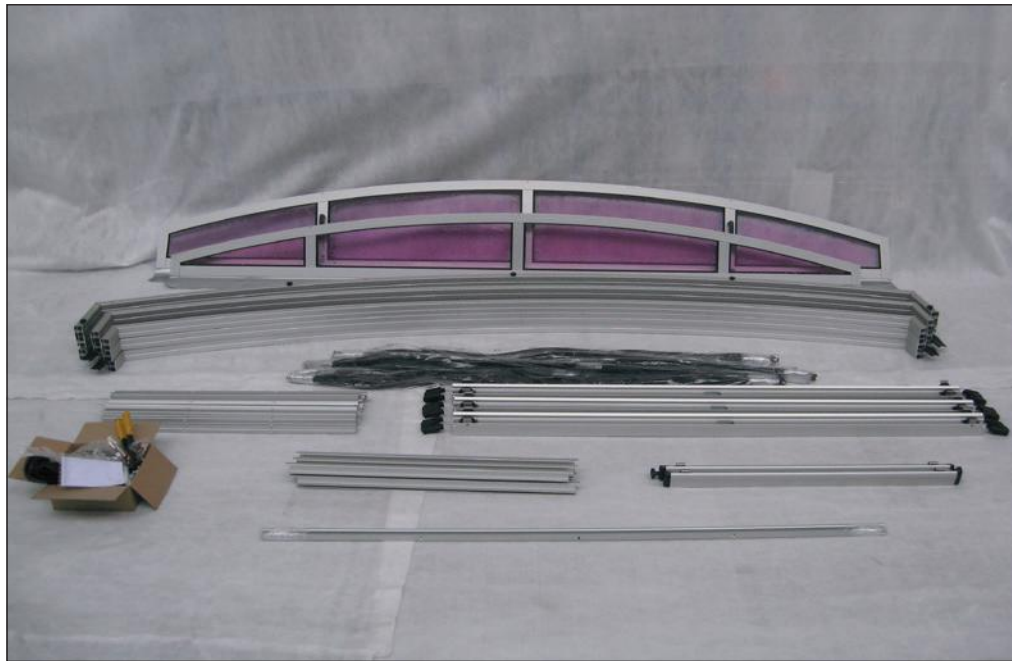

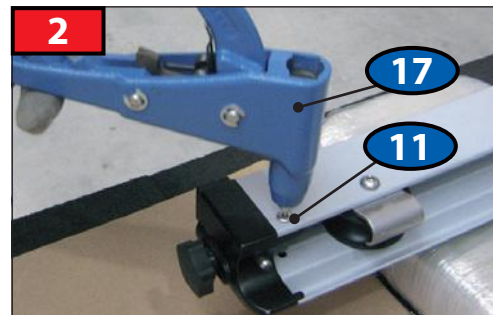
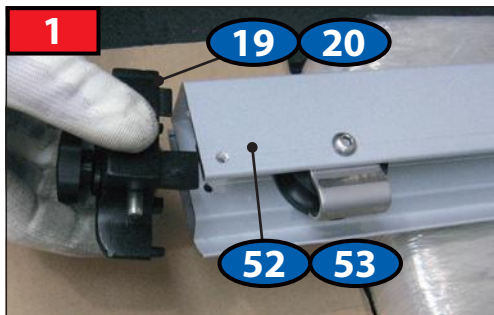
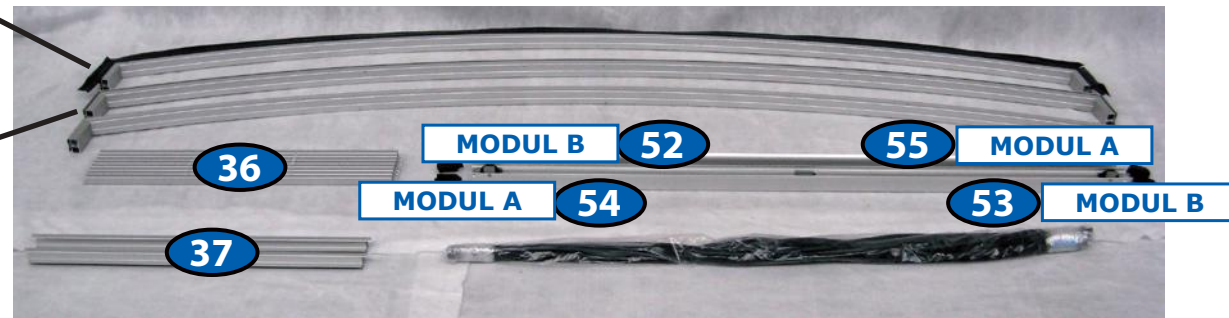
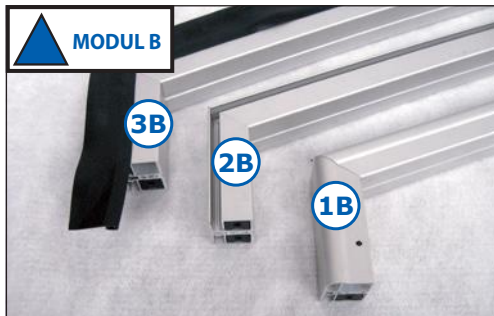
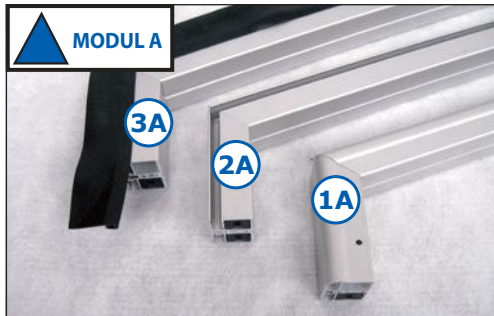
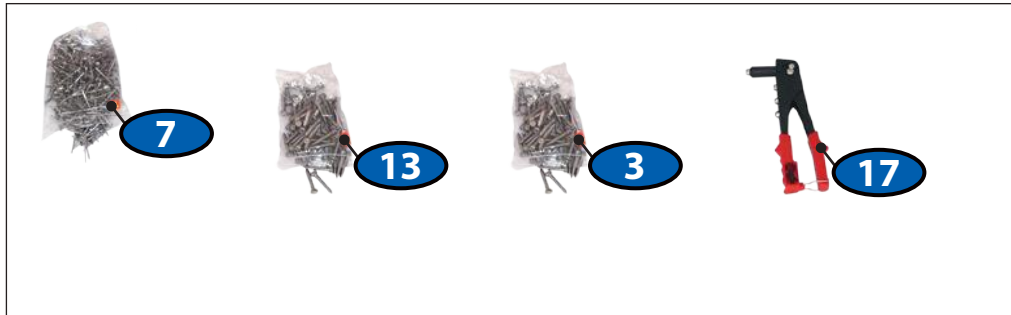

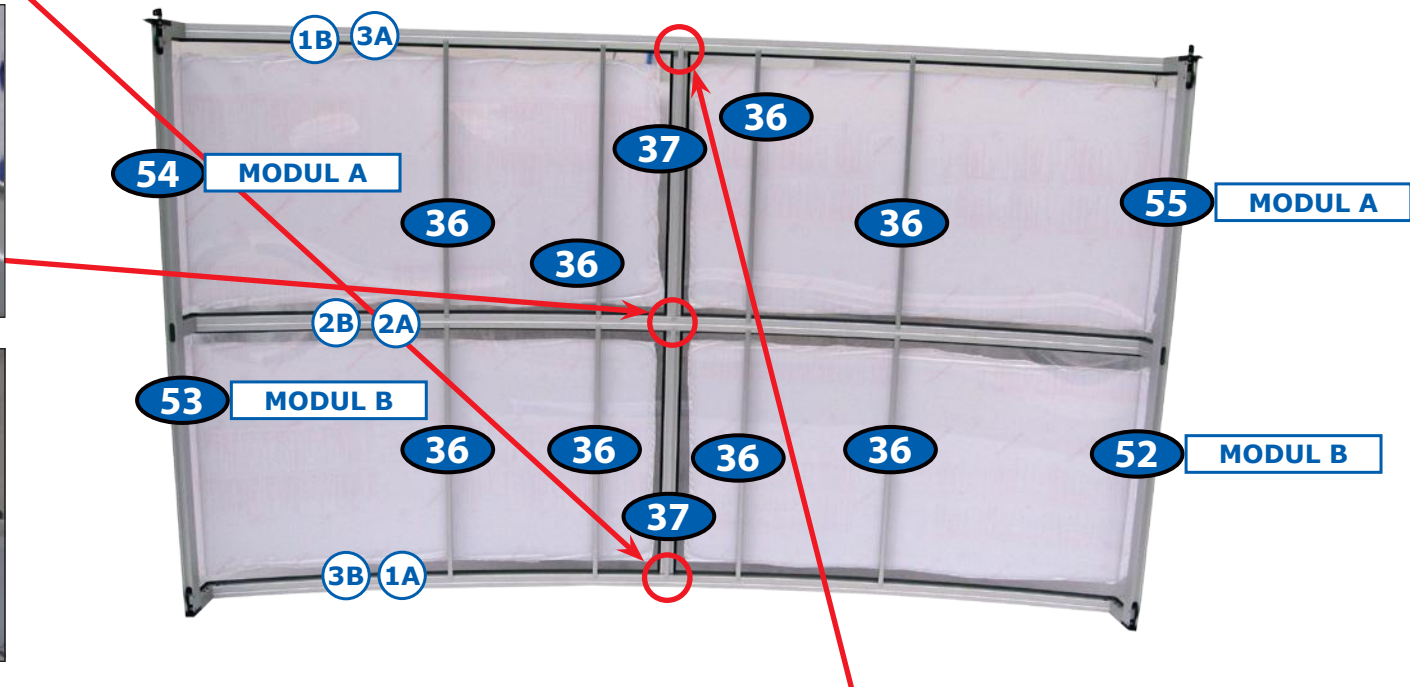
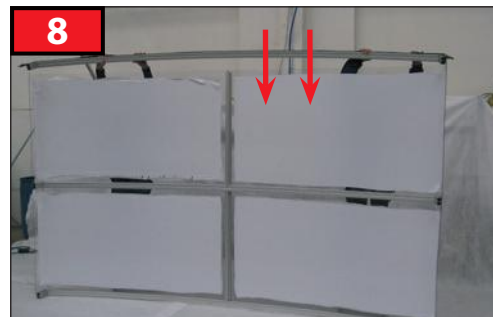
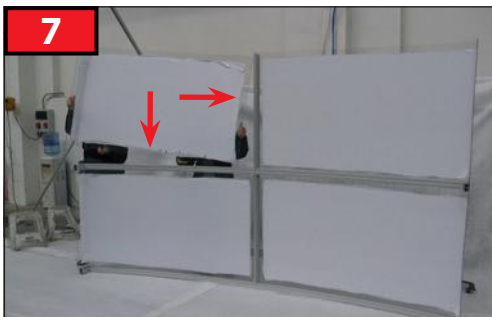
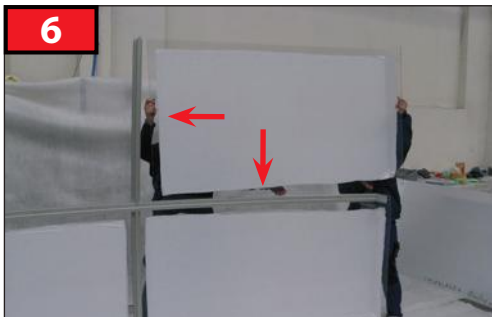
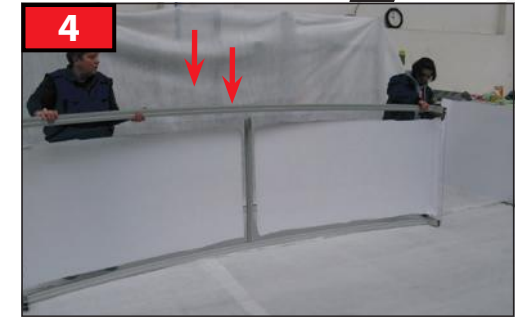
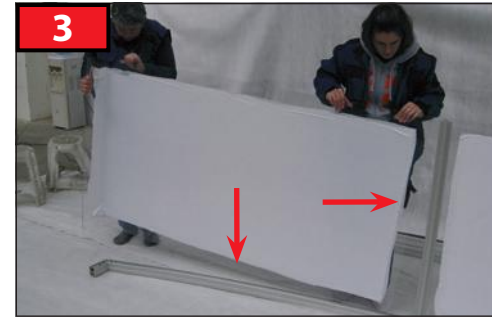

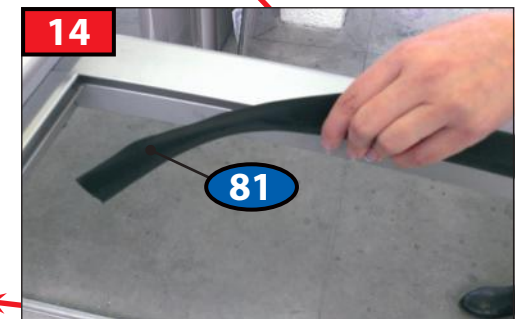
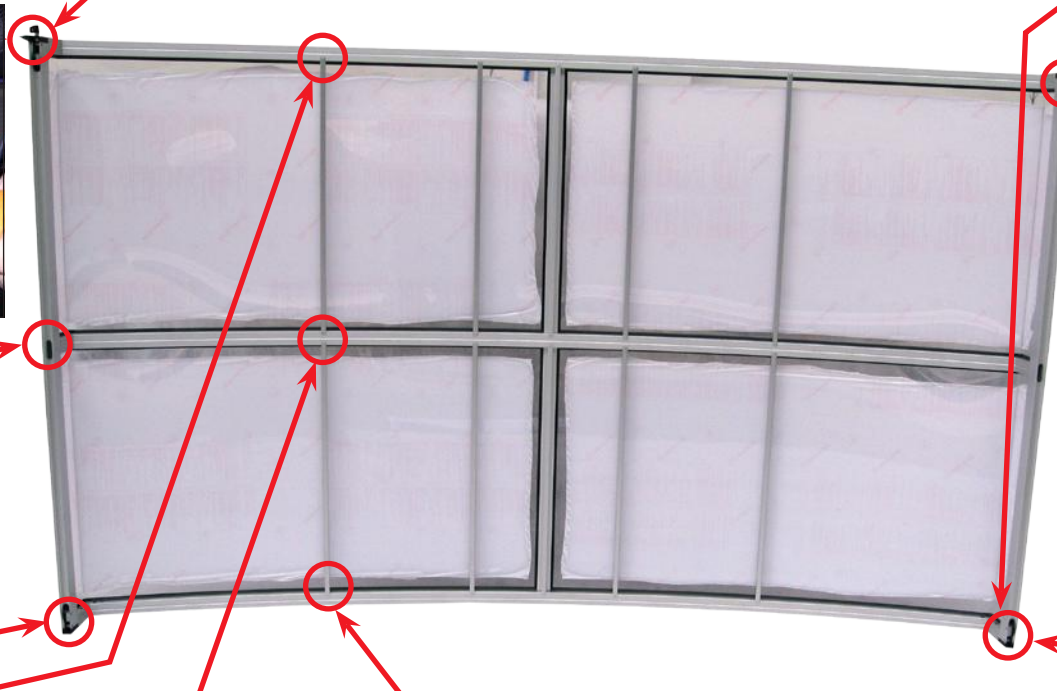
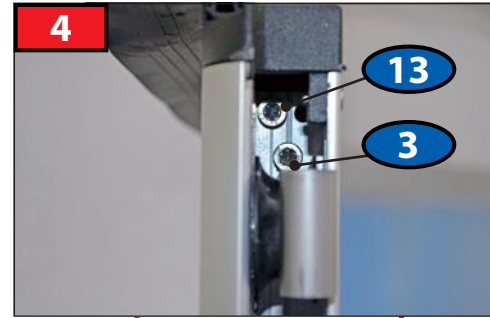
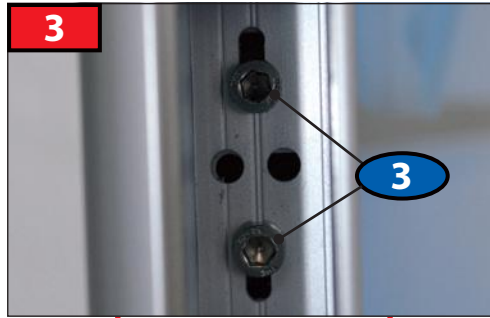
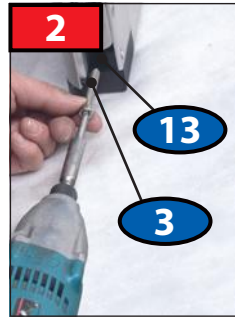

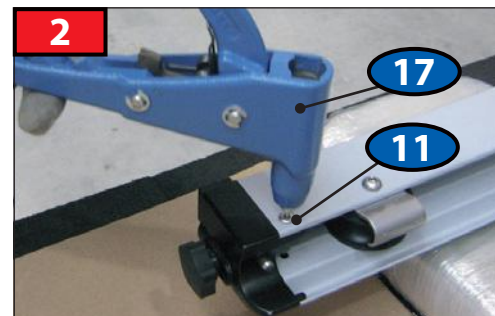
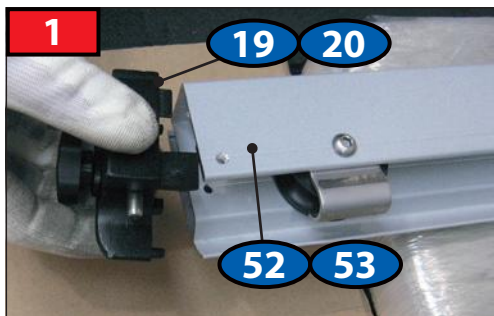
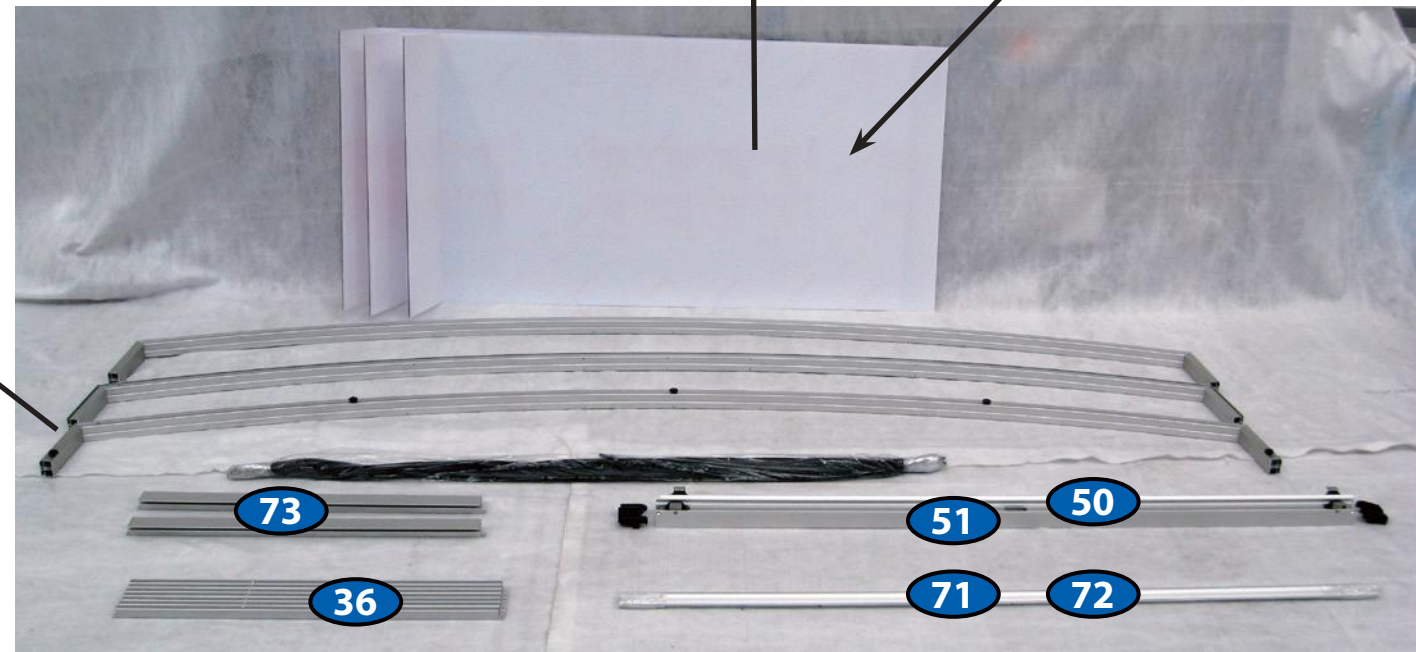
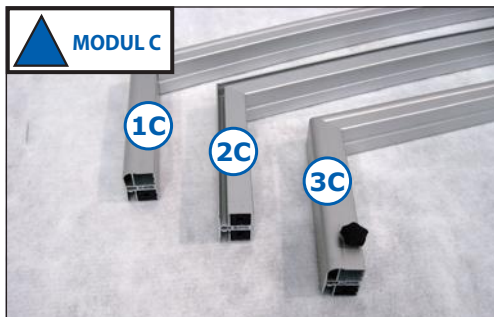
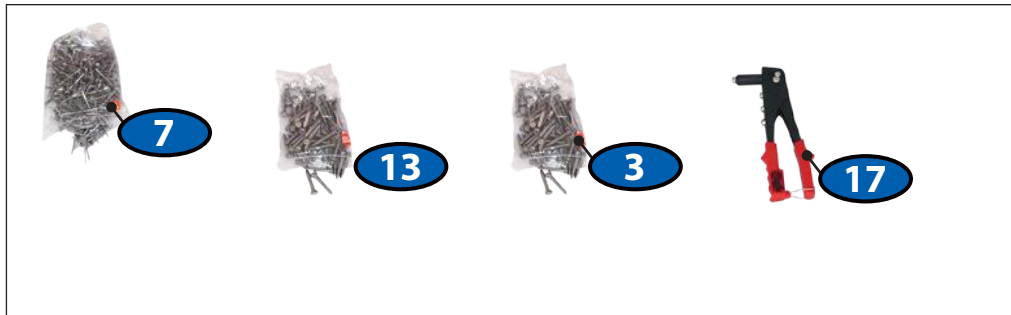



DOOR LEFT

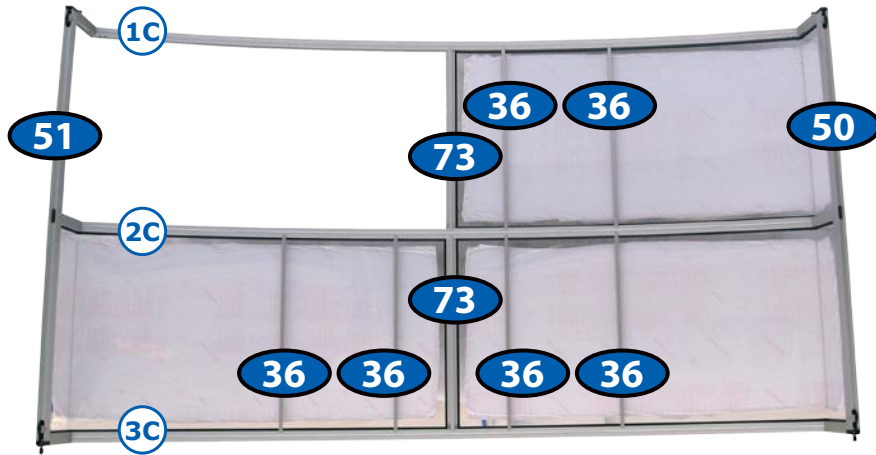

DOOR RIGHT

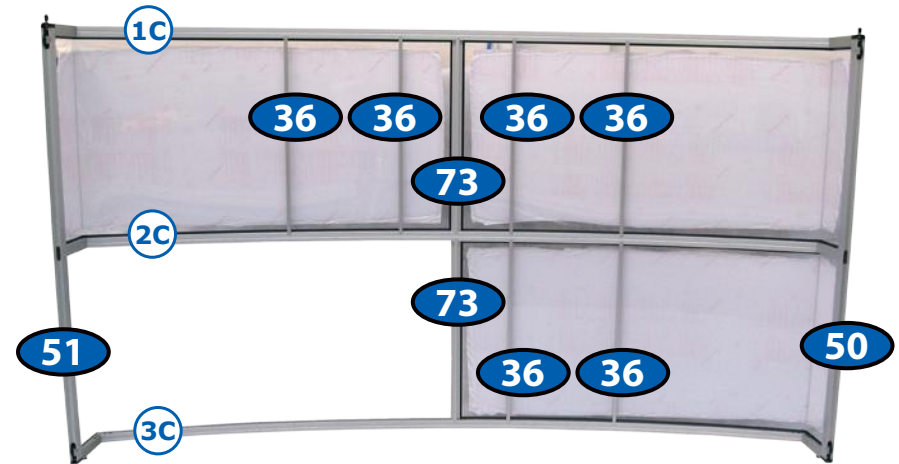
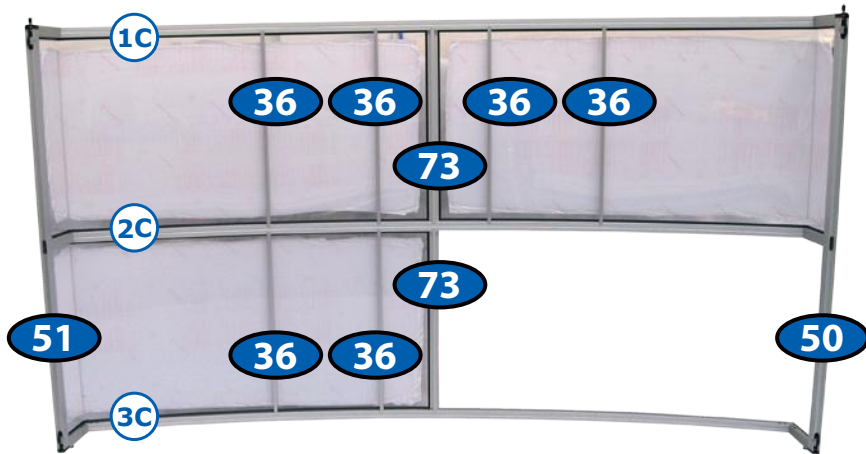
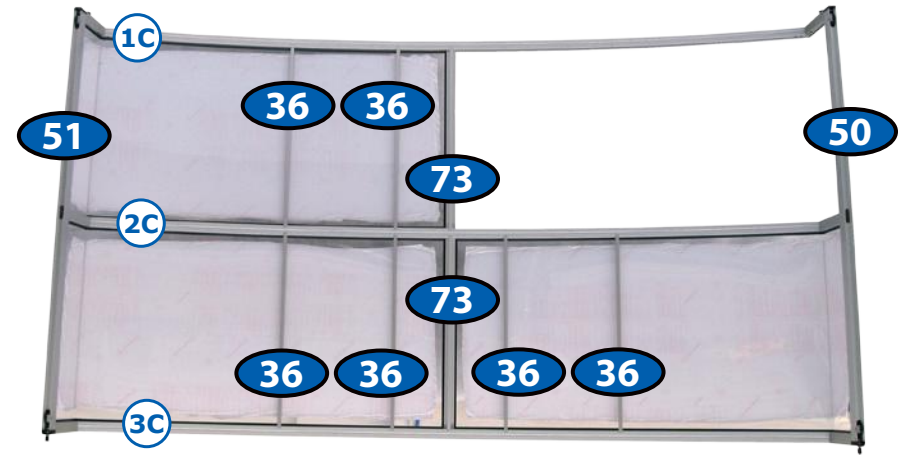

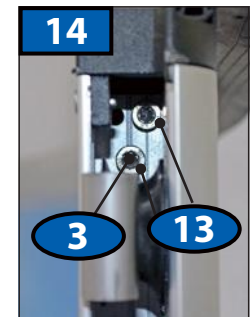
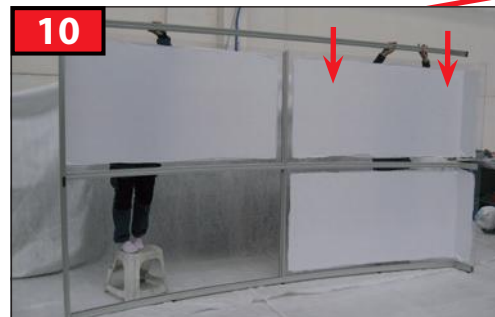
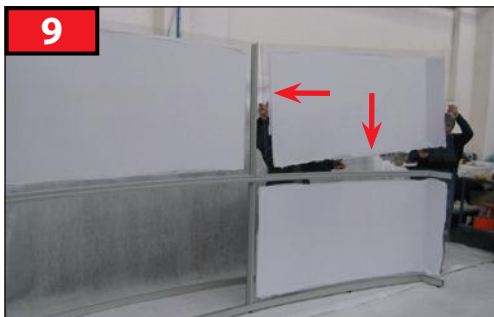
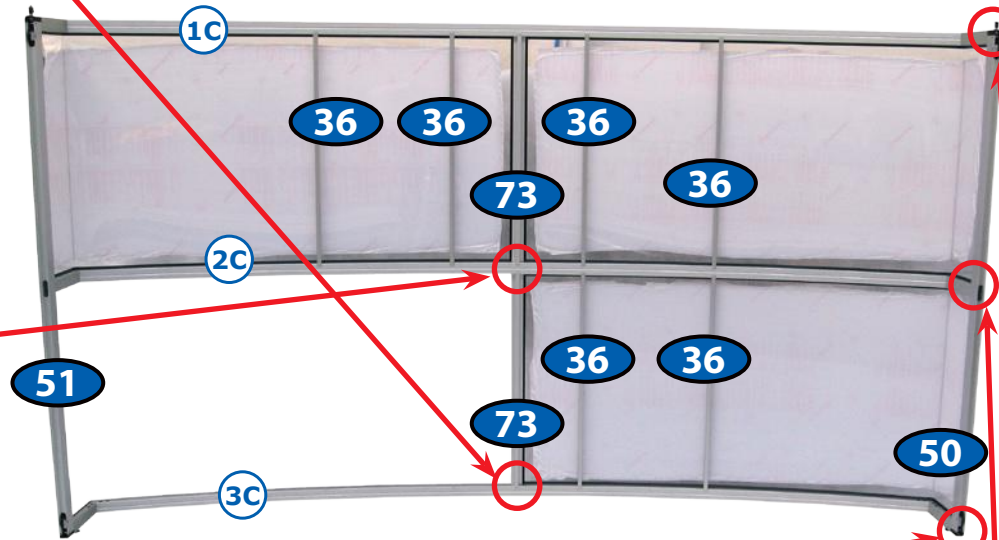
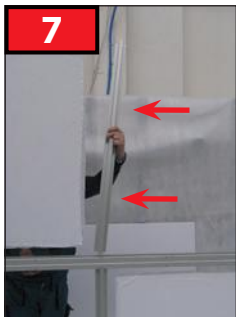
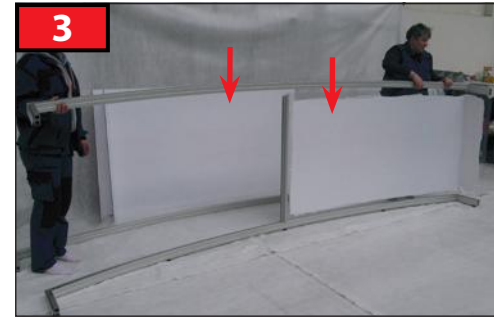
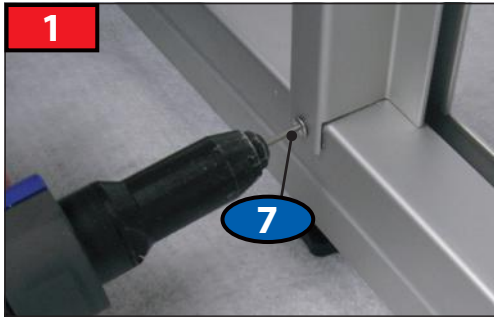

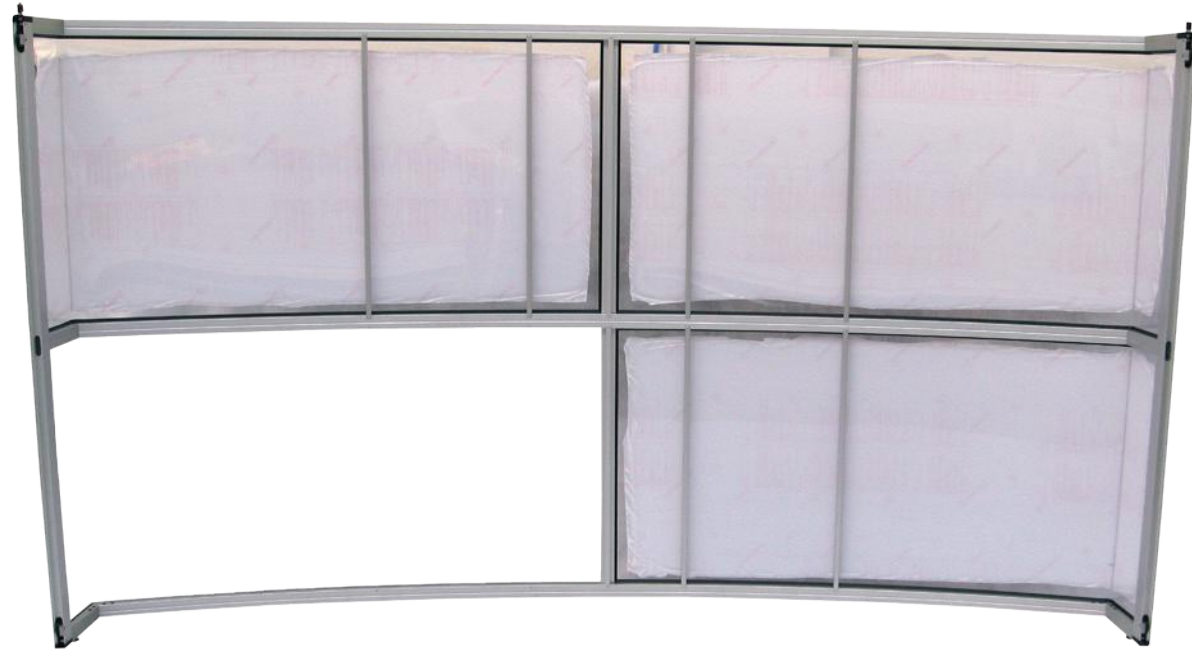
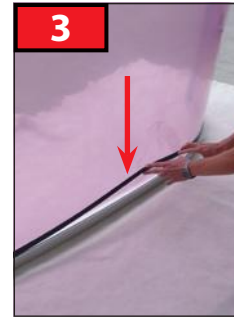

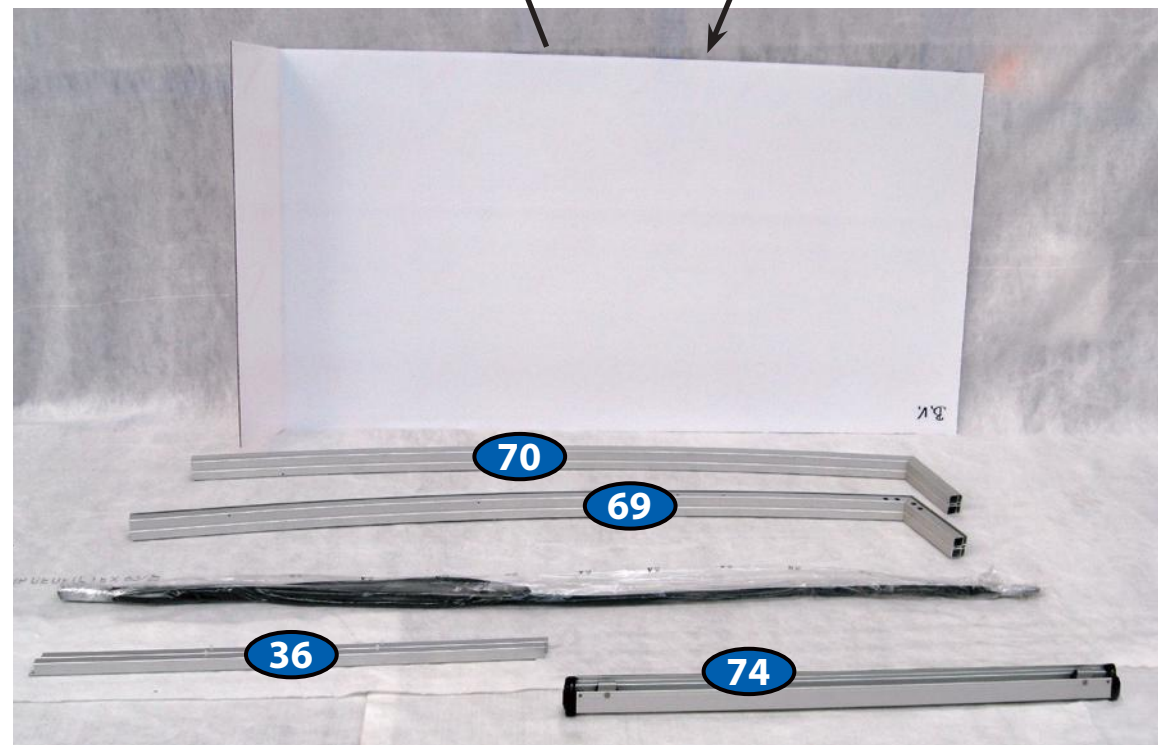

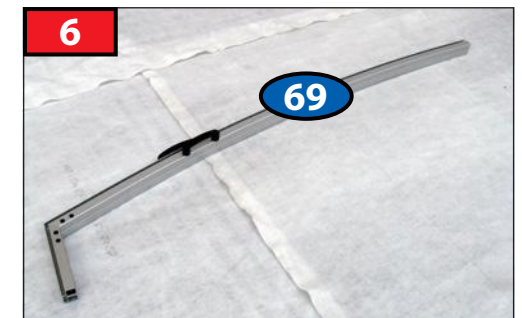

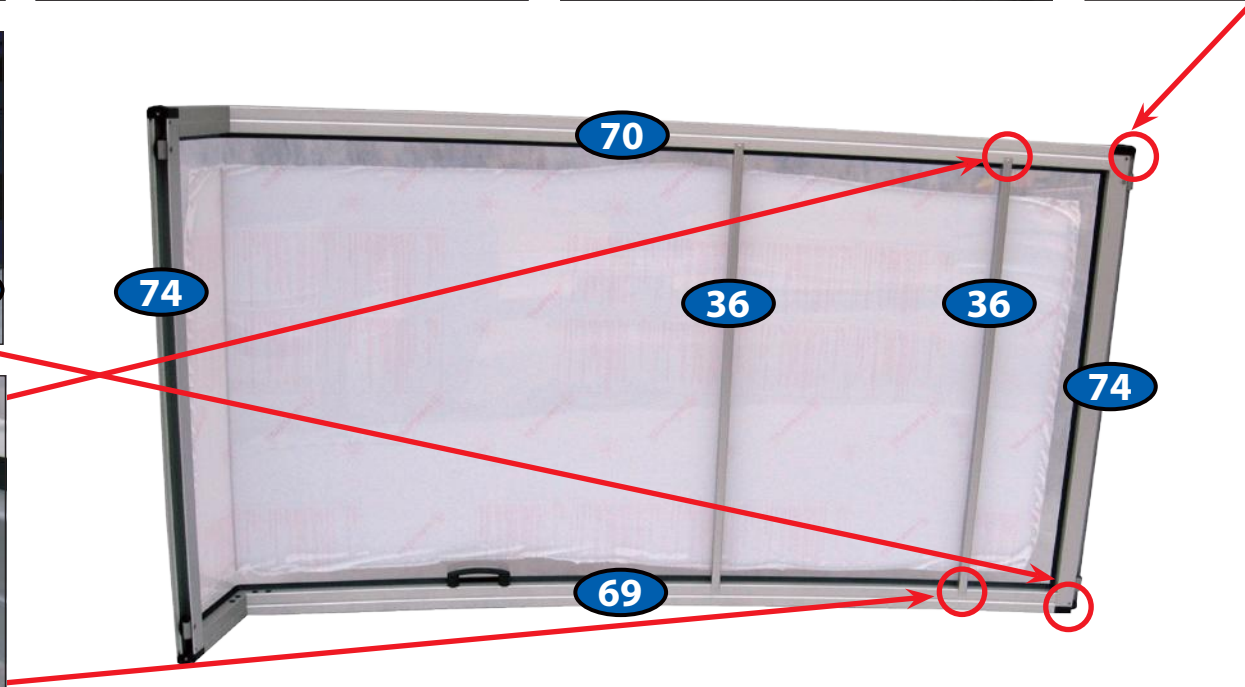
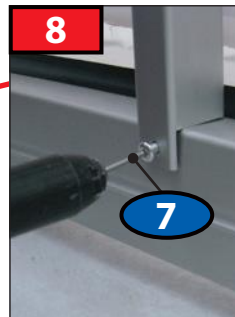
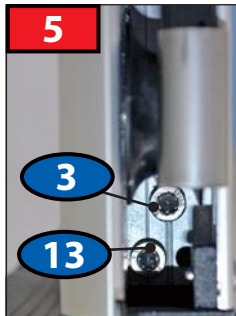
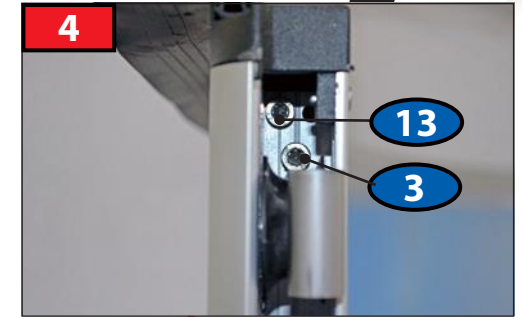
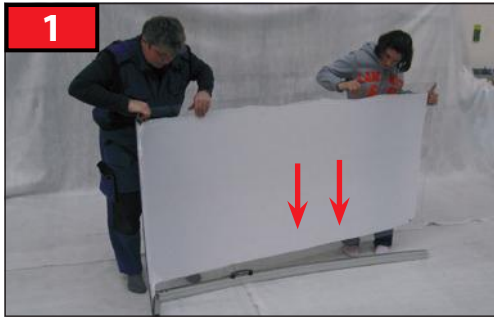

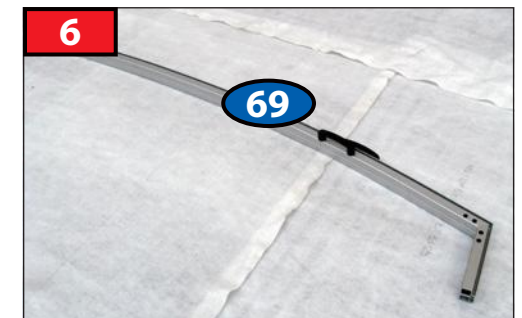

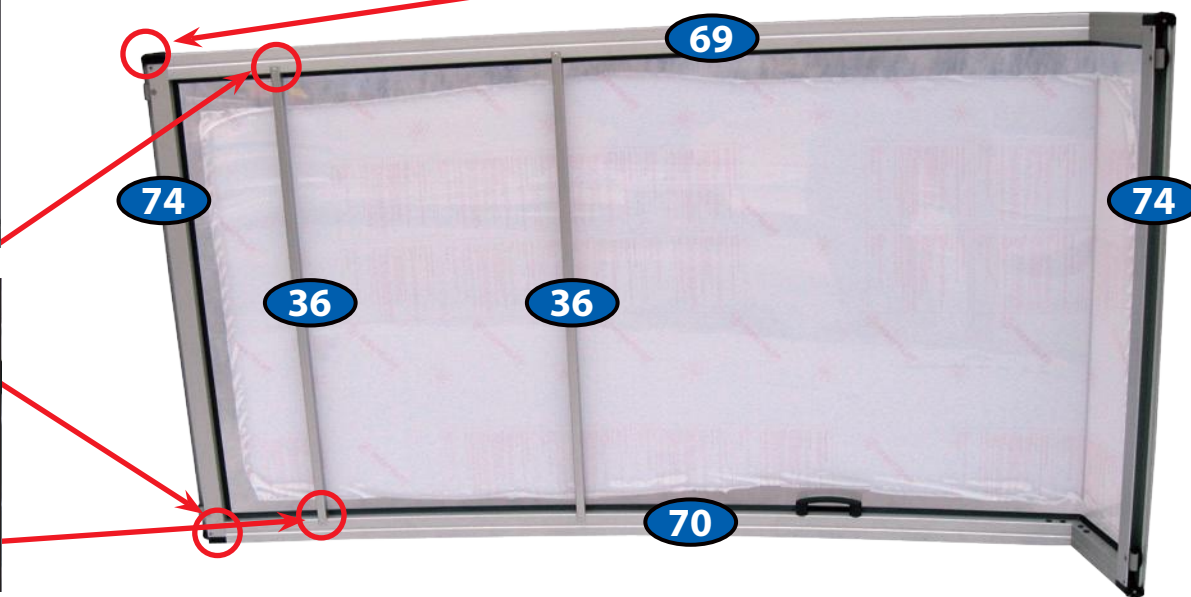
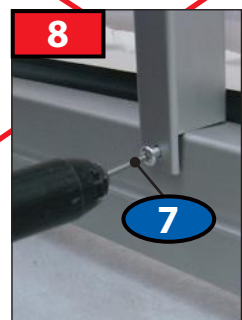
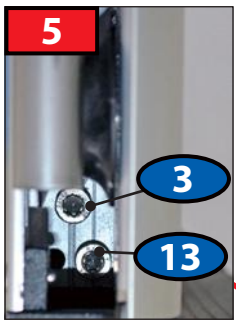
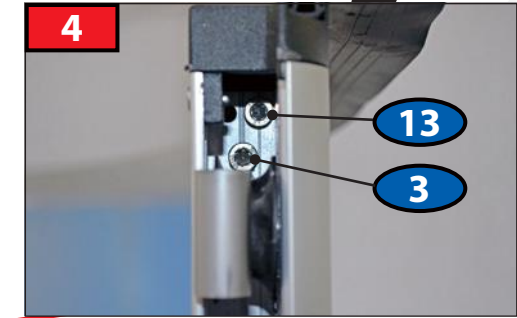
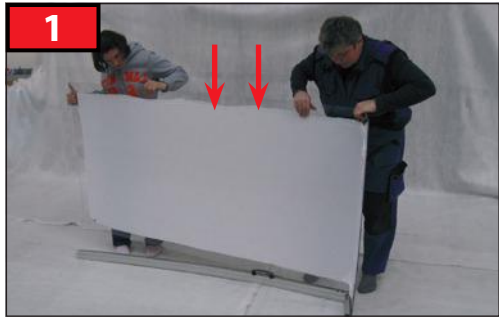

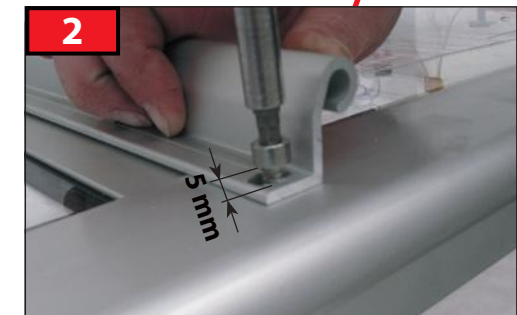
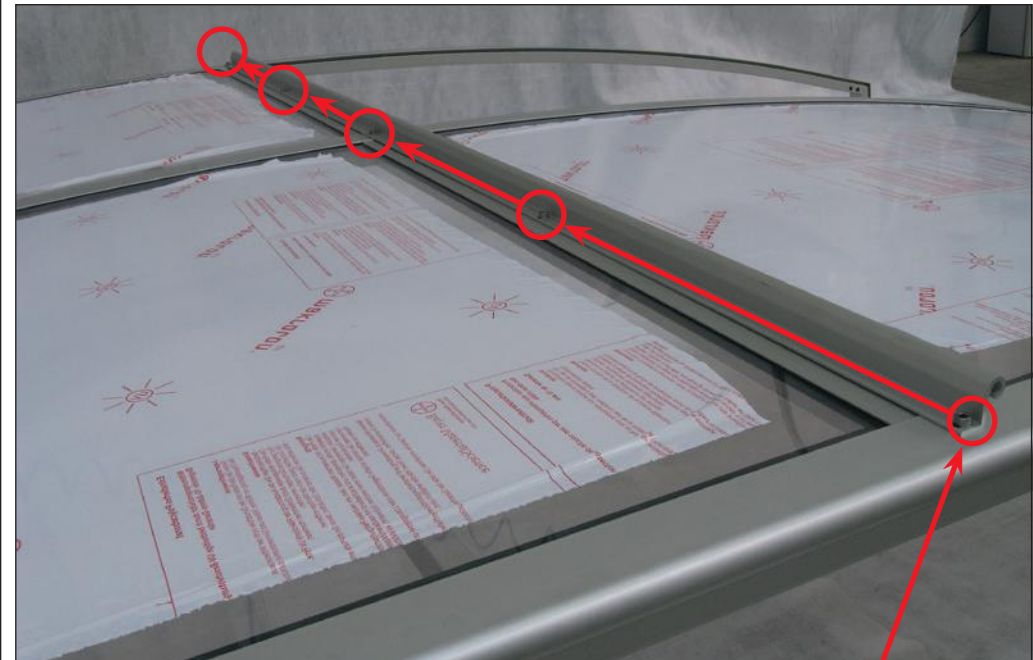
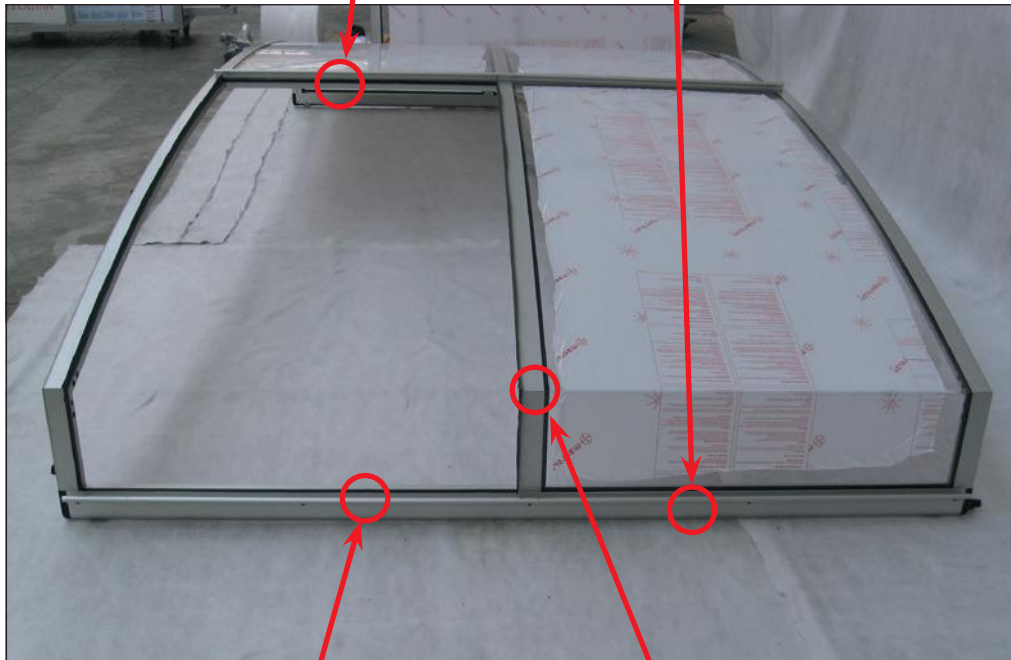
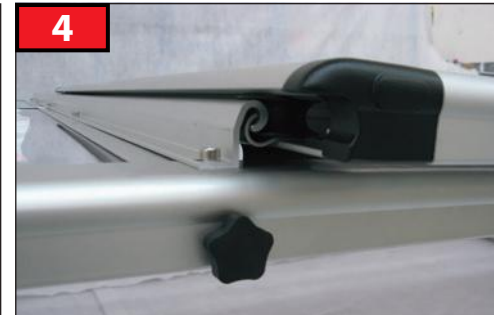

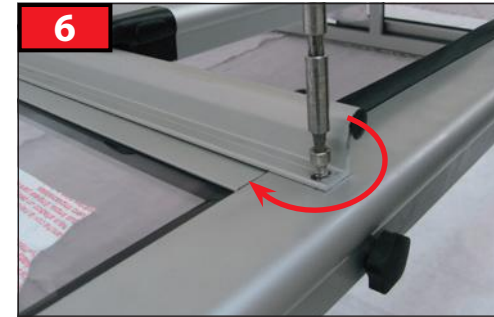
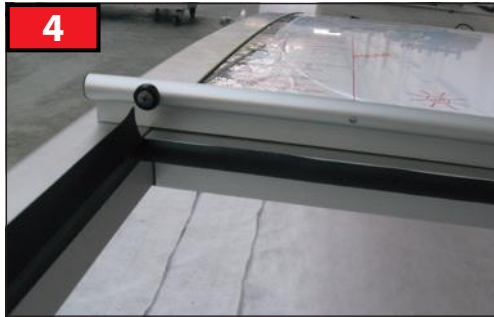

PAGE 28

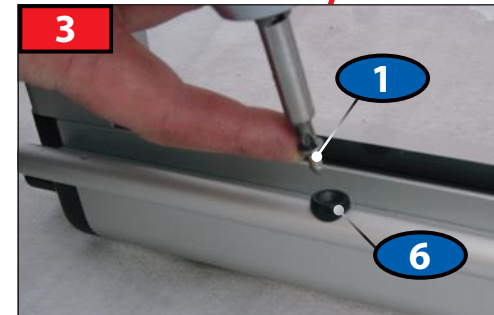
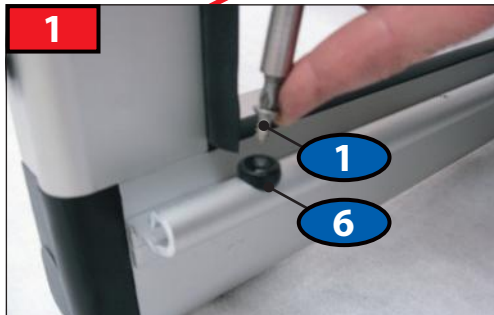

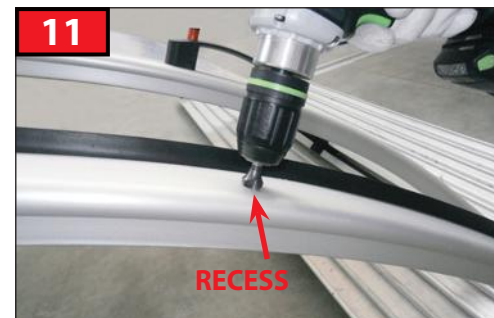
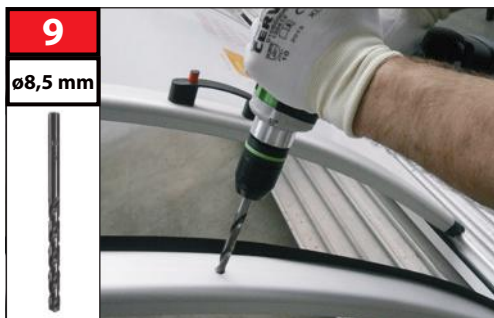
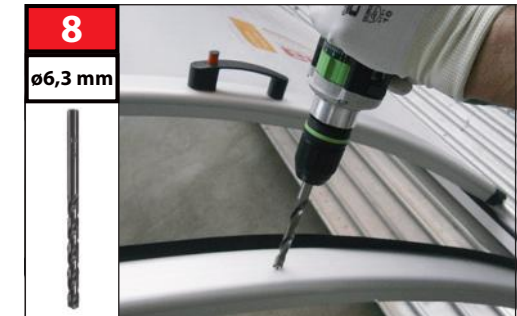
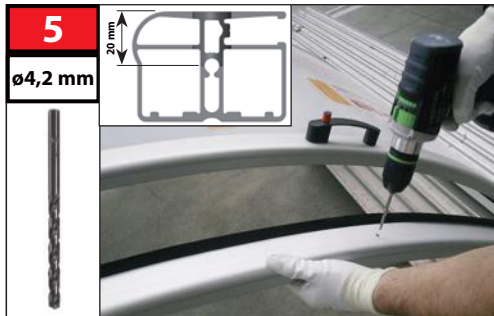
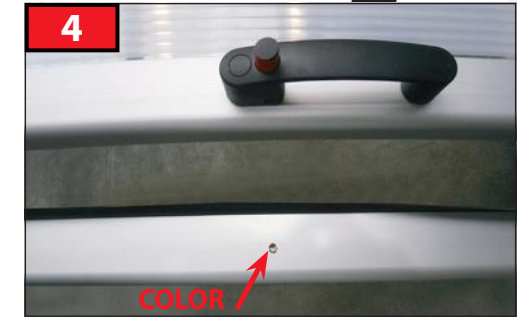

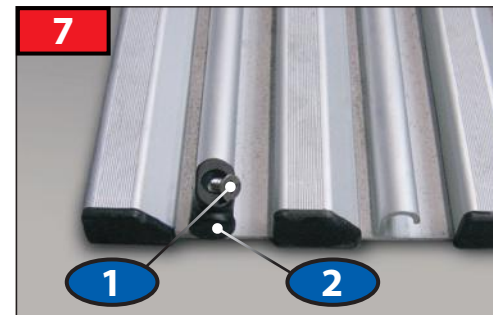
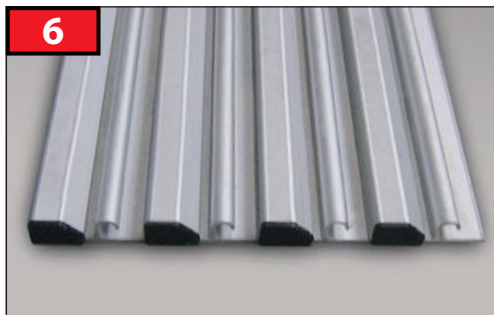
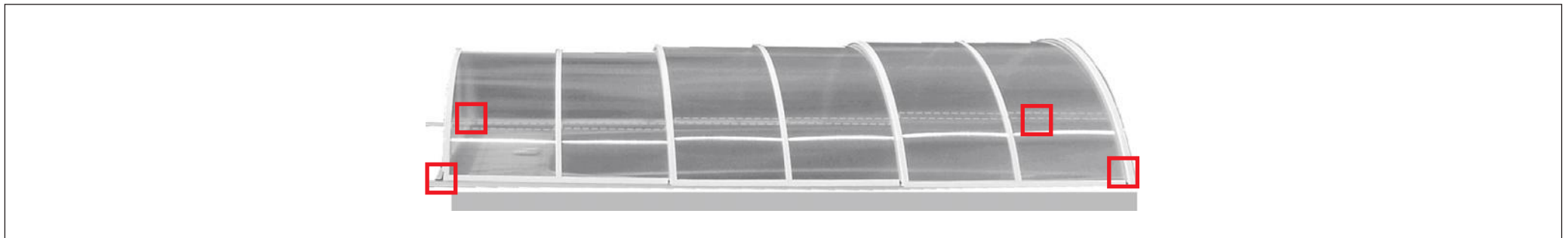
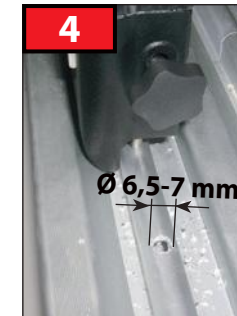
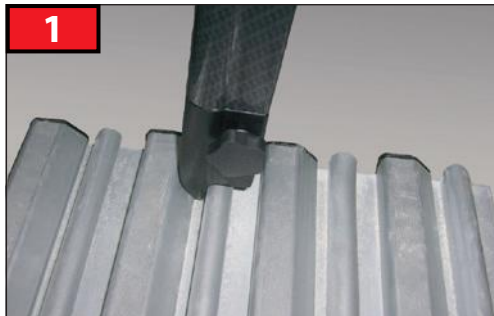
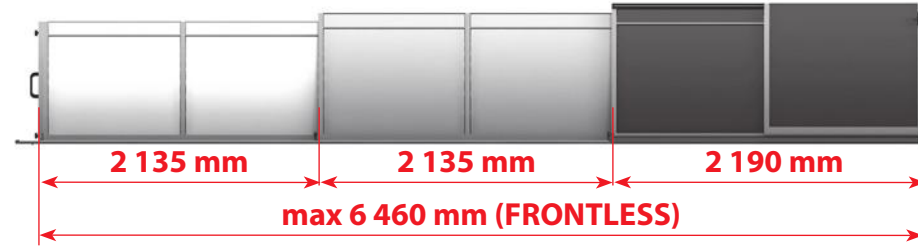

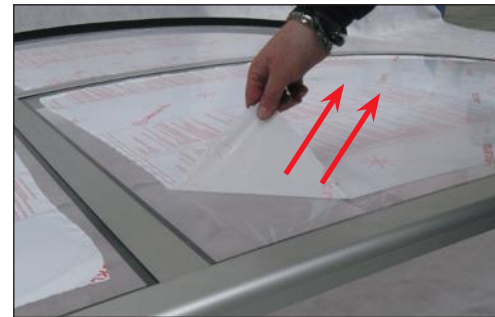
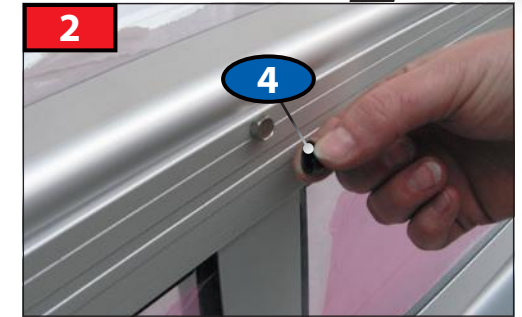
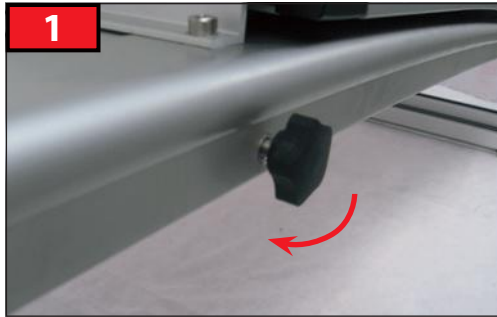

CZ

Dodavatel si vyhrazuje právo na změny a úpravy technických parametrů uváděných v tomto katalogu s ohledem na technický vývoj a zdokonalení výrobků a balení.
Dodavatel si vyhrazuje právo na tiskové chyby a chyby v sazbě.

DE

Der Lieferant behält sich das Recht auf Änderungen und Anpassungen der technischen Parameter, die in diesem Katalog aufgeführt sind, mit Rücksicht auf die technische Entwicklung und Verbesserung der Produkte und Verpackung vor. Der Lieferant behält sich das Recht auf Druckfehler und Fehler im Satz vor.

EN

The supplier reserves the right for modifications and adaptations of the technical parameters stated in this catalogue, considering the technical development and upgrade of the products and packaging. The supplier reserves the right for print errors and typographical errors.

ES

El proveedor se reserva el derecho de hacer cambios y modificaciones técnicas de los parámetros que figuran en este catálogo, con respecto al desarrollo técnico mejorando los productos y embalajes. El proveedor se reserva también el derecho a errores de impresión y composición.

FR

Le fabricant se réserve le droit de modifier les paramètres techniques cités dans ce manuel en considération du développement technique et de l'amélioration des produits et de leur emballage. Le fabricant se réserve le droit des fautes d'impression et de composition.

HU

Gyártó fenntartja jogát a katalógusban feltüntetett műszaki paraméterek változtatására a termékek és csomagolás technikai fejlesztése és tökéletesítése szerint.
Szállító: a szállító fenntartja jogát a nyomtatási és szedési hibákra.

IT

Il fornitore si riserva il diritto di effettuare modifiche e correzioni ai parametri tecnici riportati nel presente catalogo per migliorare e perfezionare dal punto di vista tecnico i prodotti e gli imballaggi. Il fornitore non esclude inoltre l'eventuale presenza di errori di stampa e di impaginazione.

PL

Dostawca zastrzega sobie prawo do zmian oraz dostosowania parametrów technicznych podanych w niniejszym katalogu z uwzględnieniem rozwoju technicznego i udoskonalania produktów oraz opakowań. Dostawca zastrzega sobie prawo do błędów druku oraz typograficznych.

PT

O provedor reserva-se o direito a efectuar alterações e adaptações de parâmetros técnicos mencionados neste catálogo, tendo em consideração o avanço técnico e melhorias de produtos e embalagens. O provedor reserva-se o direito a cometer erros de impressora e de edição.

RO

Furnizorul își rezervă dreptul de a modifica și schimba parametrii tehnici menționați în acest catalog cu privire la evoluția tehnică și perfecționarea produselor și a ambalării. Furnizorul își rezervă dreptul la greșelile de tipar și greșelile privind tarifele.

RU

Поставщик оставляет за собой право на изменение и исправление технических параметров продукции указанной в этом каталоге, с учетом технического развития, а усовершенствования изделий и его упаковки. Поставщик оставляет за собой право на опечатку в тексте и в ценах.