

Casablanca Infinity Evo A 2016

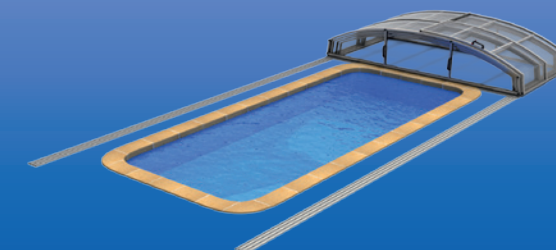

REVIZE: 2. 11. 2016

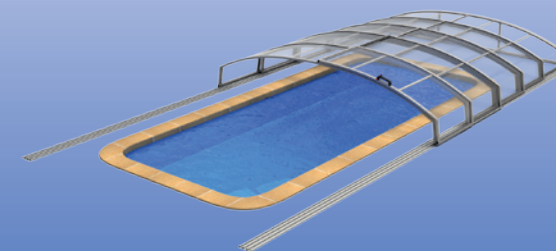
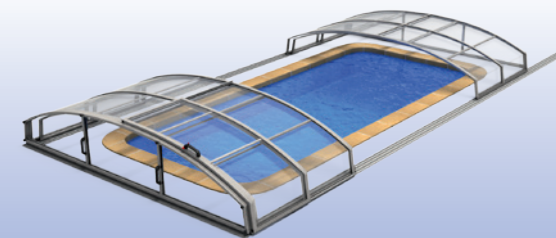
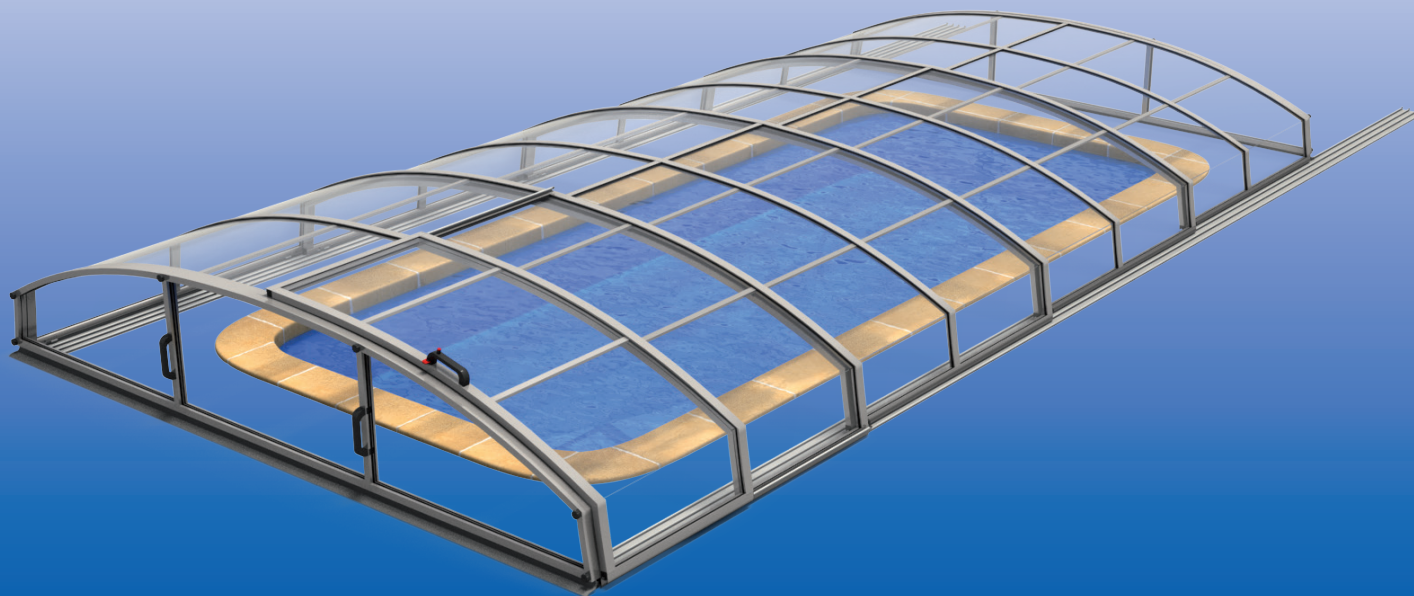
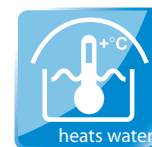

BG
 Тръгването на Casablanca Infinity Evo A 2016 е разрешено в България.
 За повече информацията за условията на продажбата и цените, моля да се свържете с нашите дилъри или директно с нас.

DE
 Verkauf und Installation von Casablanca Infinity Evo A 2016 ist in Deutschland erlaubt.
 Für weitere Informationen zu den Verkaufsbedingungen und den Preisen wenden Sie sich bitte an unsere Händler oder direkt an uns.

ES
 Casablanca Infinity Evo A 2016 está autorizado para su venta en España.
 Para más información sobre las condiciones de venta y precios, por favor contactar con nuestros distribuidores o directamente con nosotros.

FR
 Mise à disposition de Casablanca Infinity Evo A 2016 autorisée en France.
 Pour plus d'informations sur les conditions de vente et les prix, contactez nos distributeurs ou contactez-nous directement.

HU
 A Casablanca Infinity Evo A 2016 forgalmazása engedélyezett Magyarországon.
 További információkért kérjük, forduljon a forgalmazóhoz vagy közvetlenül hozzánk.

CN
 Casablanca Infinity Evo A 2016 获准在中国大陆销售。
 如需了解销售条件和价格，请联系我们的经销商或与我们联系。

LT
 Casablanca Infinity Evo A 2016 yra leidžiama parduoti Lietuvoje.
 Dėl pildesnių informacijos apie pardavimo sąlygas ir kainas, prašome kreiptis į pardavėją arba tiesiogiai į mus.

PL
 Sprzedaż i montaż Casablanca Infinity Evo A 2016 jest dozwolony w Polsce.
 Więcej informacji o warunkach sprzedaży i cenach, prosimy o kontakt z naszymi dystrybutorami lub bezpośrednio z nami.

RU
 Продажа и установка Casablanca Infinity Evo A 2016 разрешены в России.
 Для получения информации о условиях продажи и ценах, пожалуйста, свяжитесь с нашими дилерами или обратитесь к нам.

SL
 Prodaja in namestitveni Casablanca Infinity Evo A 2016 sta dovoljena v Sloveniji.
 Za več informacij o pogoje prodaje in cene, prosimo, da se obrnete na naše prodajalne točke ali neposredno na nas.

CZ
 Prodej a instalace Casablanca Infinity Evo A 2016 je povoleno v České republice.
 Pro více informací o podmínkách prodeje a cenách, prosíme kontaktovat naše prodejce nebo nás přímo.

DK
 Salg og installation af Casablanca Infinity Evo A 2016 er tilladt i Danmark.
 For yderligere oplysninger om salgsbetingelser og priser, bedes du kontakte vores forhandlere eller os direkte.

EE
 Casablanca Infinity Evo A 2016 on lubatud müüa Eestis.
 Täpsemate informatsioonide saamiseks võite pöörduda meie müüjate või meie enda poole.

GB
 The swimming pool enclosure Casablanca Infinity Evo A 2016 is available for sale in the United Kingdom.
 For more information on the selling conditions and prices, please contact our distributors or contact us directly.

HR
 Prodaja i instalacija Casablanca Infinity Evo A 2016 dozvoljena je u Hrvatskoj.
 Za više informacija o uvjetima prodaje i cijenama, molimo kontaktirati naše distributere ili nas direktno.

IT
 Copertura per piscine Casablanca Infinity Evo A 2016 è autorizzata per la vendita in Italia.
 Per maggiori informazioni sulle condizioni di vendita e sui prezzi, si prega di contattare i rivenditori o direttamente noi.

LV
 Casablanca Infinity Evo A 2016 ir atļauts pārdot Latvijā.
 Par papildu informāciju par pārdošanas nosaukumiem un cenām, lūgums sazināties ar mūsu pārdevējiem vai tieši ar mums.

RO
 Acoperiturile pentru piscine Casablanca Infinity Evo A 2016 sunt autorizate pentru vânzare în România.
 Pentru mai multe informații despre condițiile de vânzare și prețuri, vă rugăm să contactați distribuitorii sau să ne scrieți direct.

SE
 Försäljning och installation av Casablanca Infinity Evo A 2016 är tillåtet i Sverige.
 För ytterligare information om försäljningsvillkor och priser, vänligen kontakta våra återförsäljare eller oss själva.

SK
 Prodej a instalace Casablanca Infinity Evo A 2016 je povoleno v Slovenskej republice.
 Pre viac informácií o podmienkach predaja a cenách, prosíme kontaktovať naše predajcov alebo nás priamo.

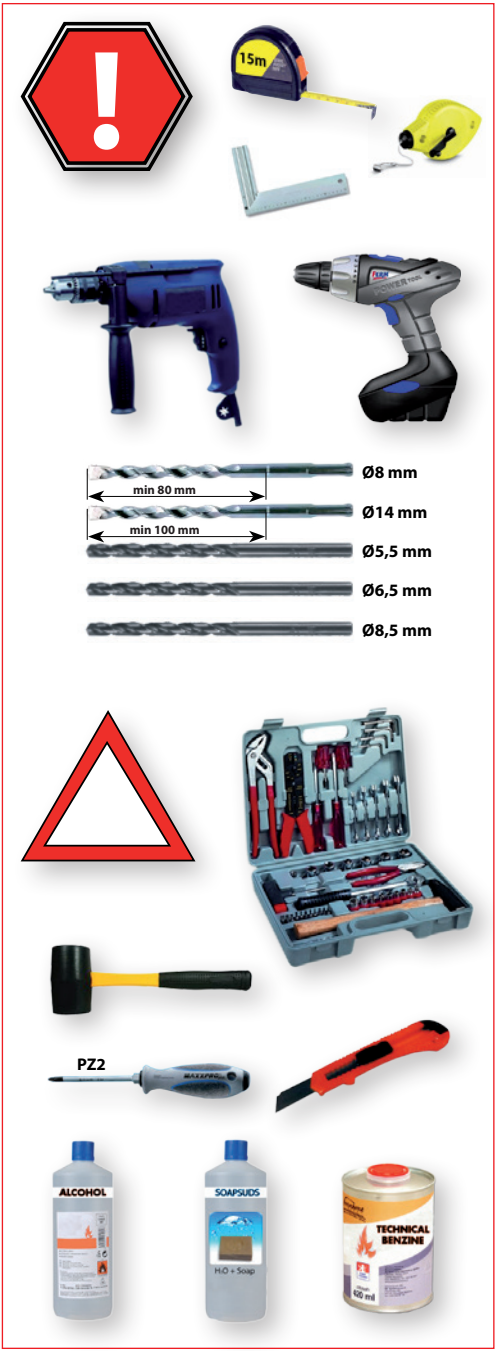

DIN 7982
4,8 x 13
12x
1

650.01.8811.2
12x
2

AN 9051
6,3 x 50
24x
3

007.20.1501.2
5x
4

DIN 7976
6,3 x 38
5x
5

007.02.0030.2
ø4 x 10
96x
7

007.10.7012.2
ø8 x 80
48x
9

007.02.0092.2
ø4 x 14
4x
11

AN 9051
6,3 x 38
12x
13

ø4,2
1x
14

1x
17

1x
18

097.02.0046.2
2x
19

097.02.0047.2
2x
20

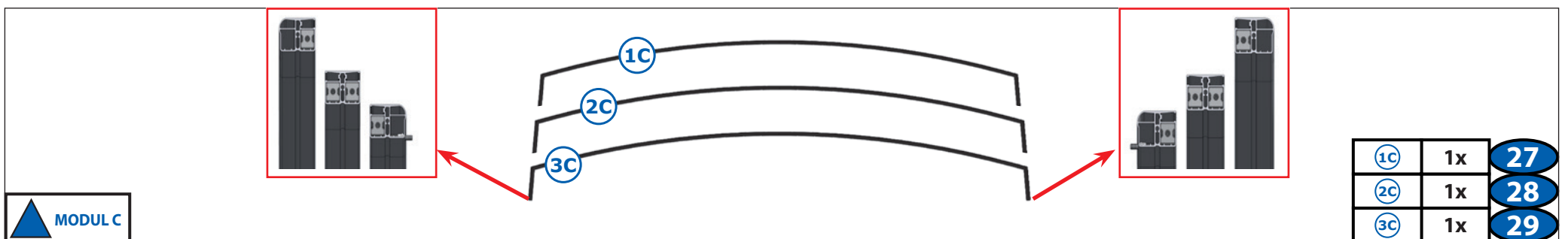
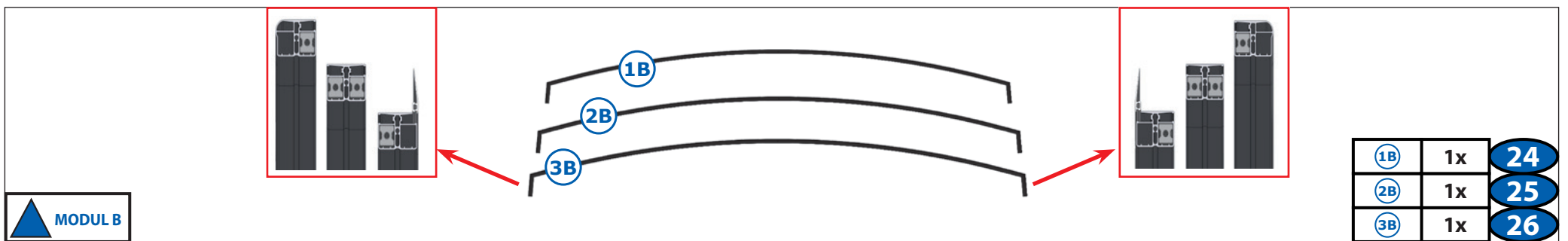
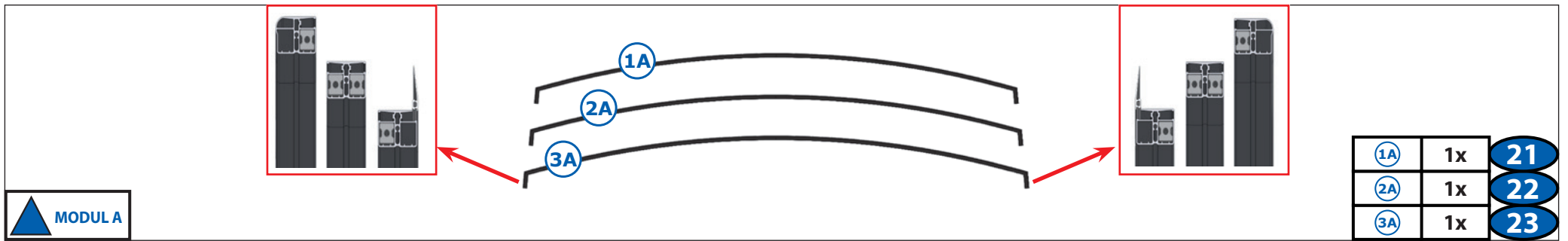
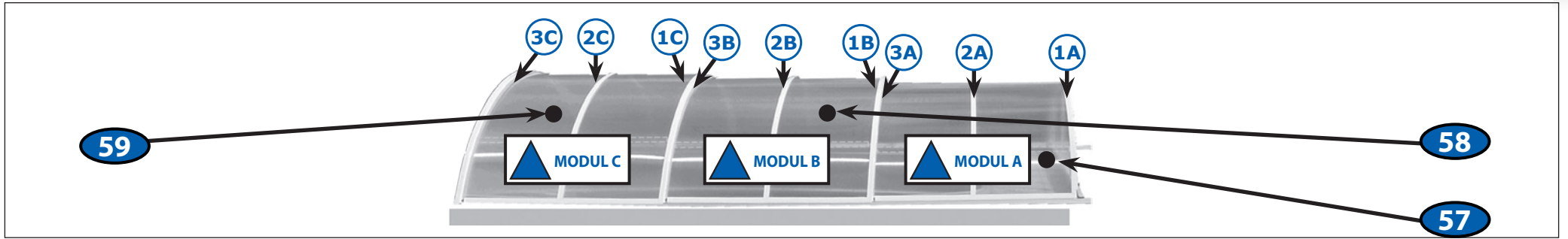



1041 mm
24x
36

6x
37

A
3230 mm
2x
40

D
3230 mm
2x
46

MODUL C

1x
50

Detailed description: This diagram illustrates the assembly of Module C. It features a motor on the left, a long drive shaft in the center, and a pulley system on the right. Red boxes highlight the motor, the shaft's connection points, and the pulley. Red arrows point from the shaft to the motor and the pulley. A label 'MODUL C' is in the top right, and '1x' and '50' are in a box at the bottom right.

MODUL C

1x
51

Detailed description: This diagram illustrates the assembly of Module C. It features a motor on the left, a long drive shaft in the center, and a pulley system on the right. Red boxes highlight the motor, the shaft's connection points, and the pulley. Red arrows point from the shaft to the motor and the pulley. A label 'MODUL C' is in the top right, and '1x' and '51' are in a box at the bottom right.

MODUL B

1x
52

Detailed description: This diagram illustrates the assembly of Module B. It features a motor on the left, a long drive shaft in the center, and a pulley system on the right. Red boxes highlight the motor, the shaft's connection points, and the pulley. Red arrows point from the shaft to the motor and the pulley. A label 'MODUL B' is in the top right, and '1x' and '52' are in a box at the bottom right.

MODUL B

1x
53

MODUL A

1x
54

MODUL A

1x
55

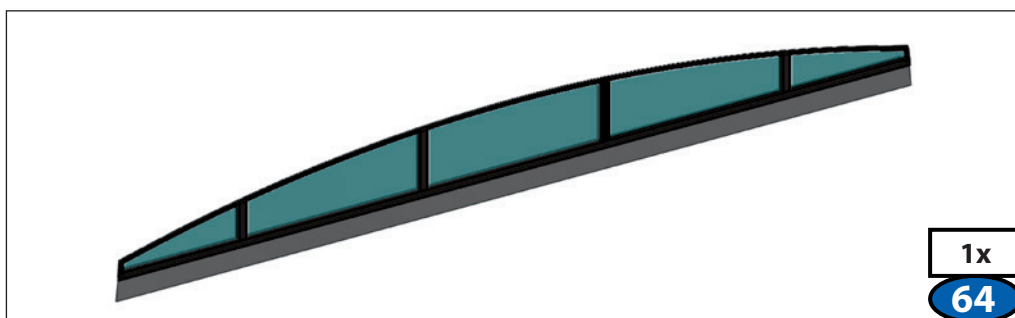
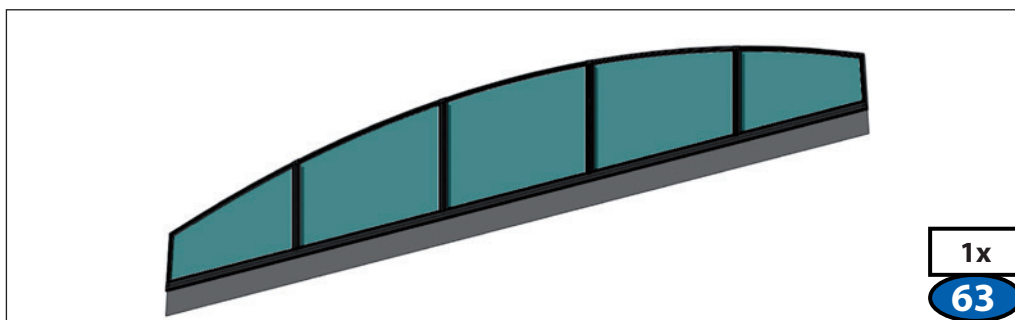
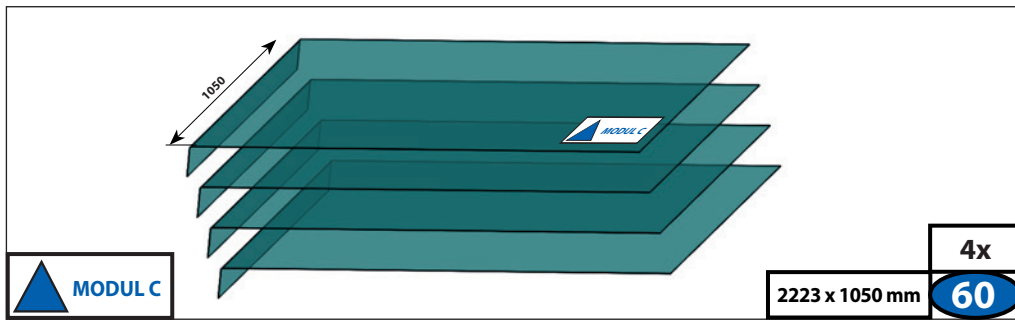
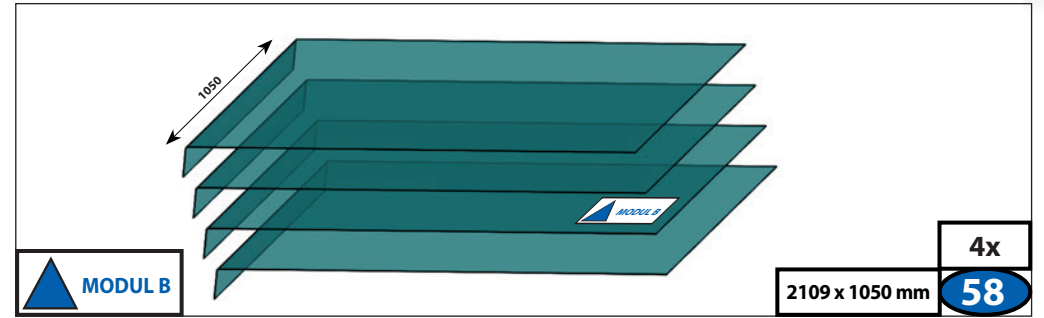
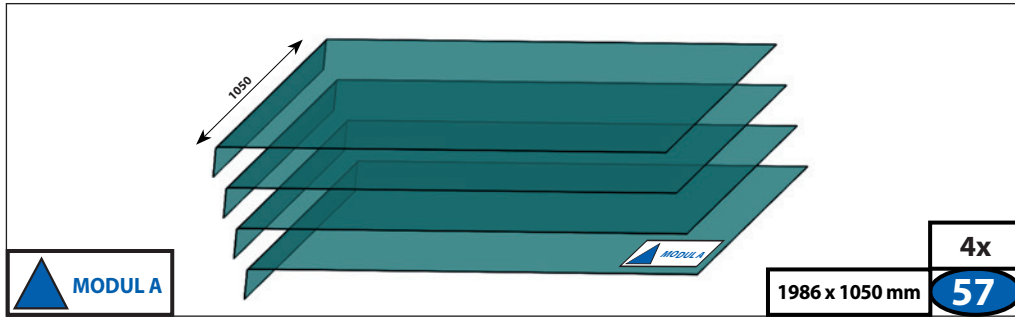



MODUL A

1986 mm	8x
1050 mm	8x
92	

MODUL B

2109 mm	8x
1050 mm	8x
93	

MODUL C

2223 mm	8x
1050 mm	8x
96	

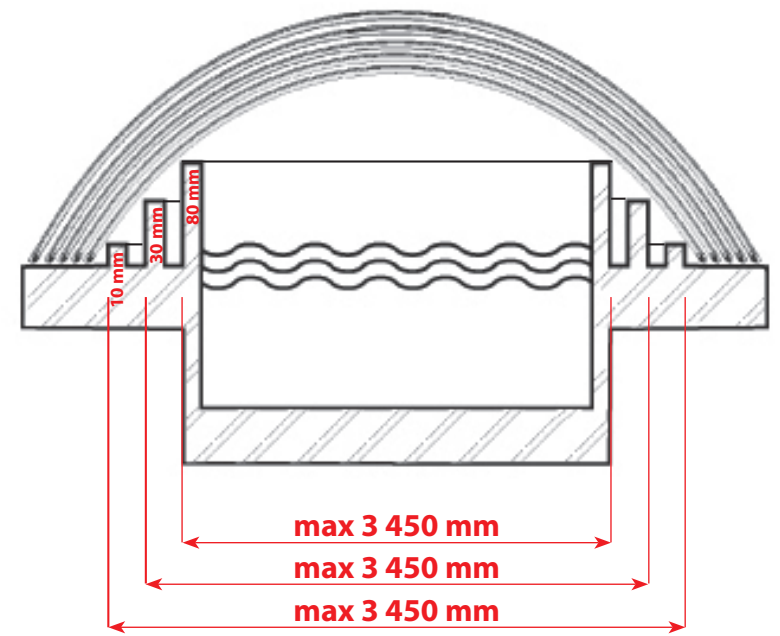
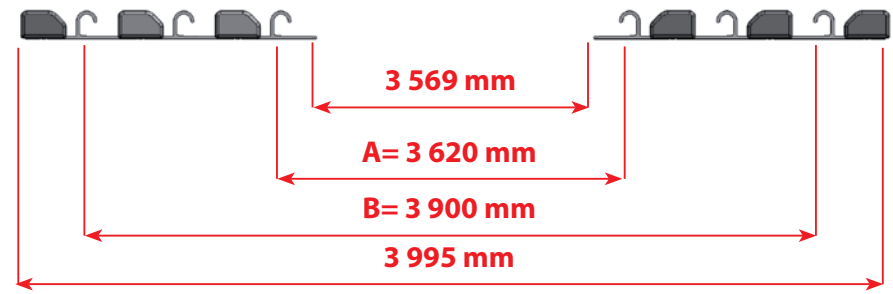
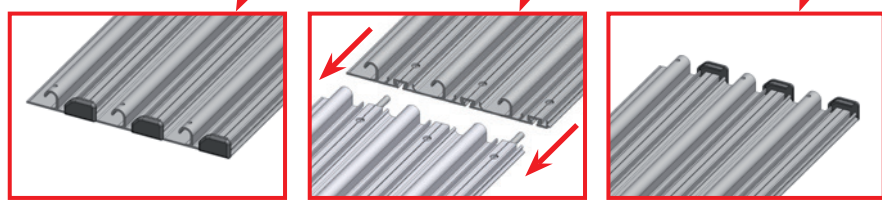
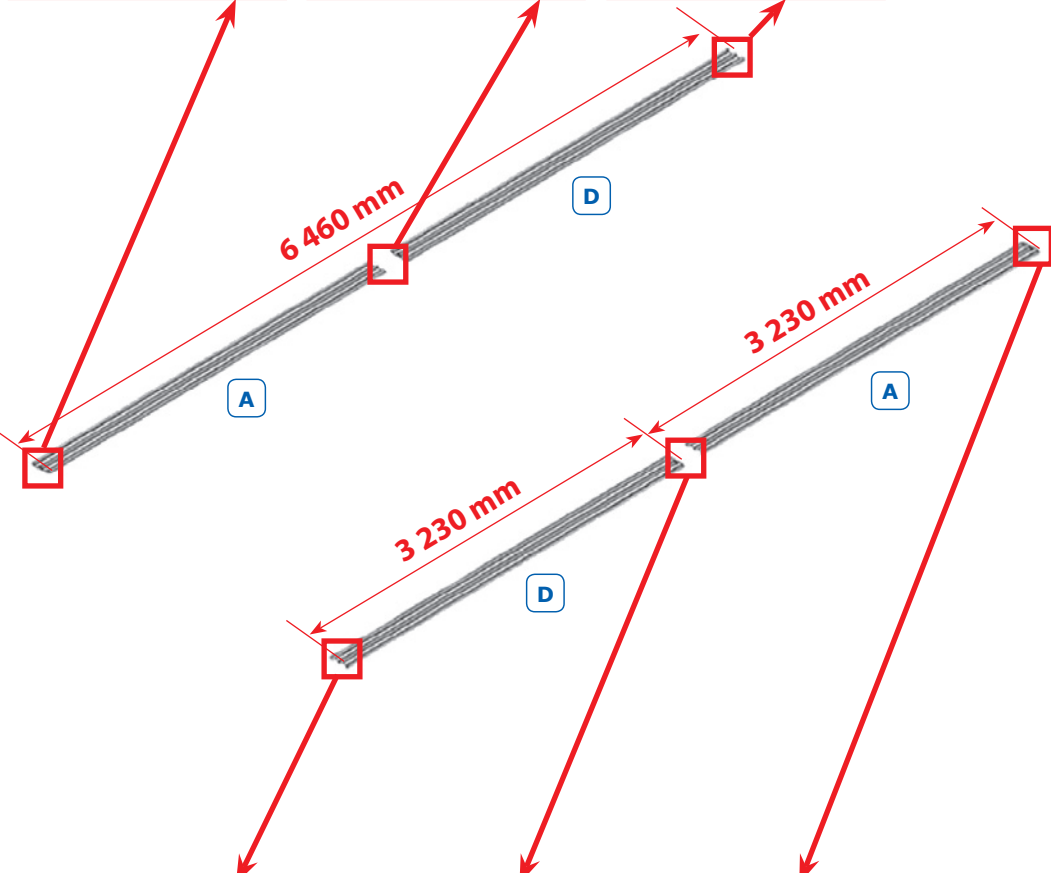
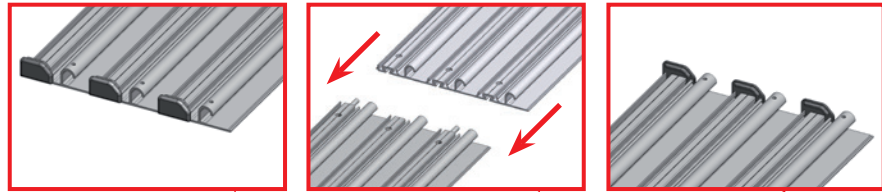

2x	41
2x	47

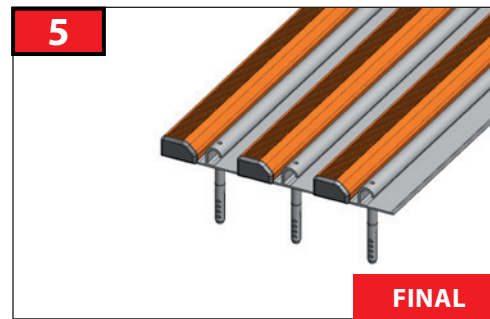
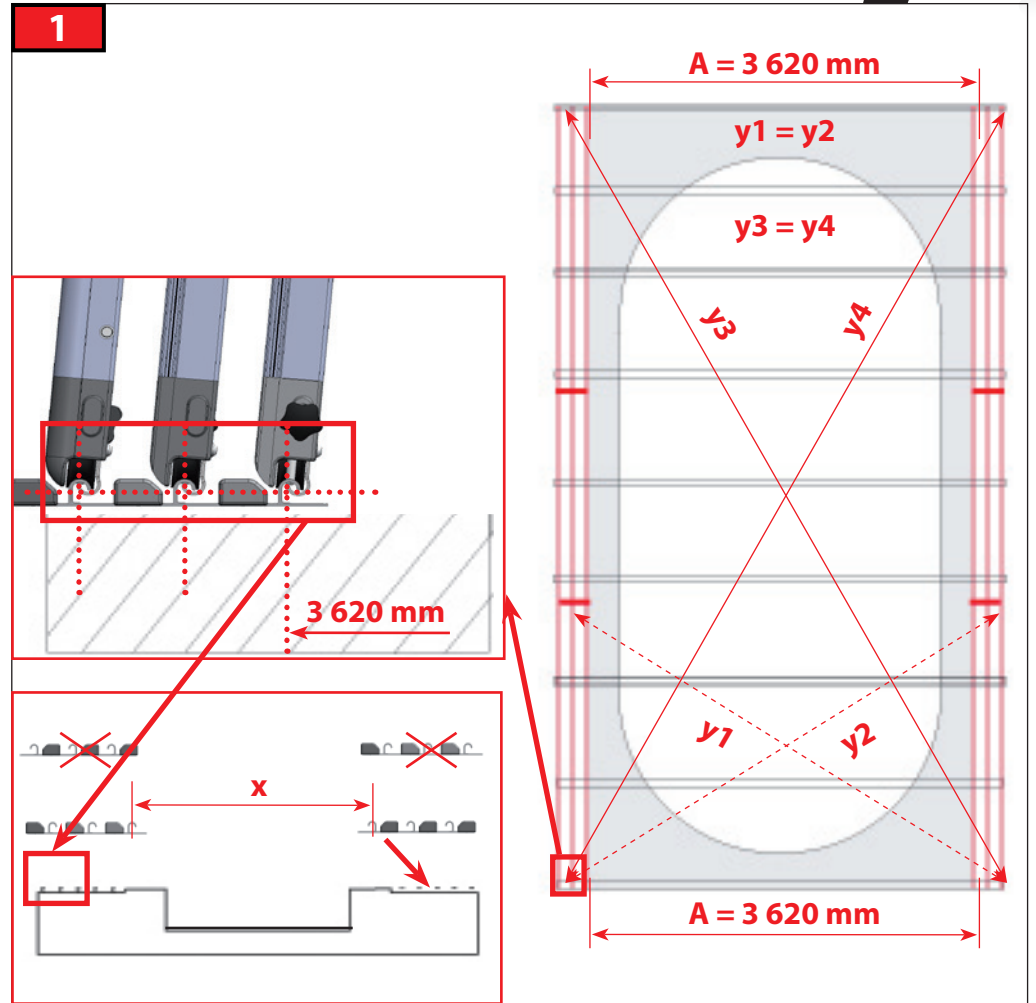
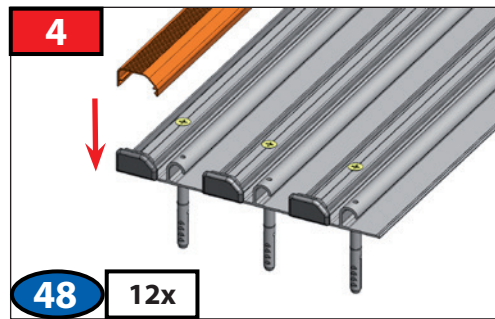
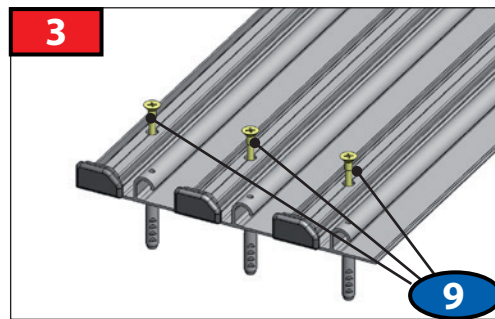
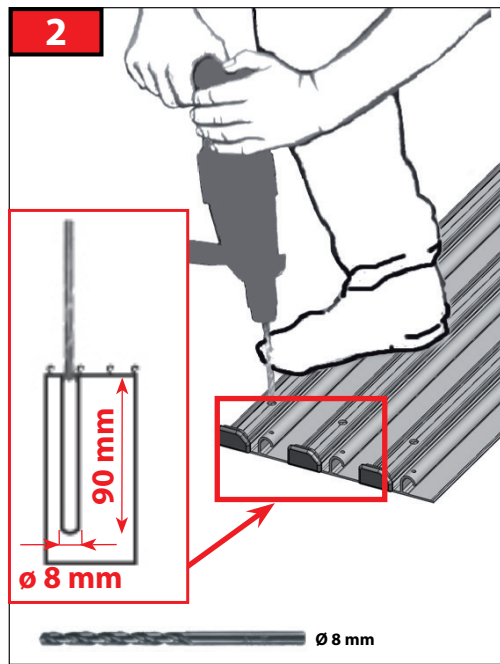
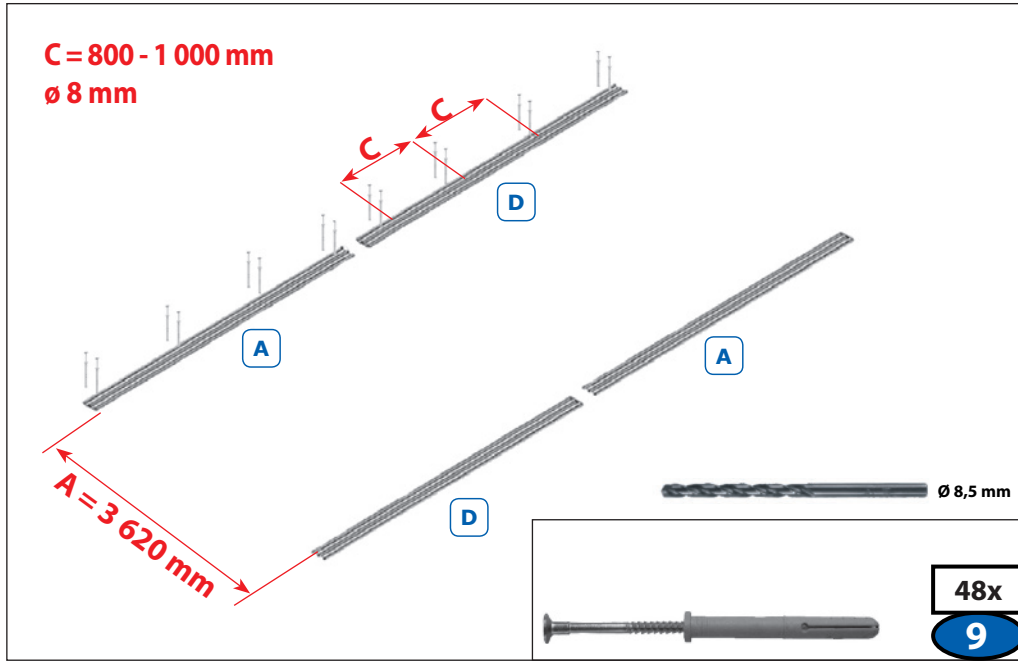

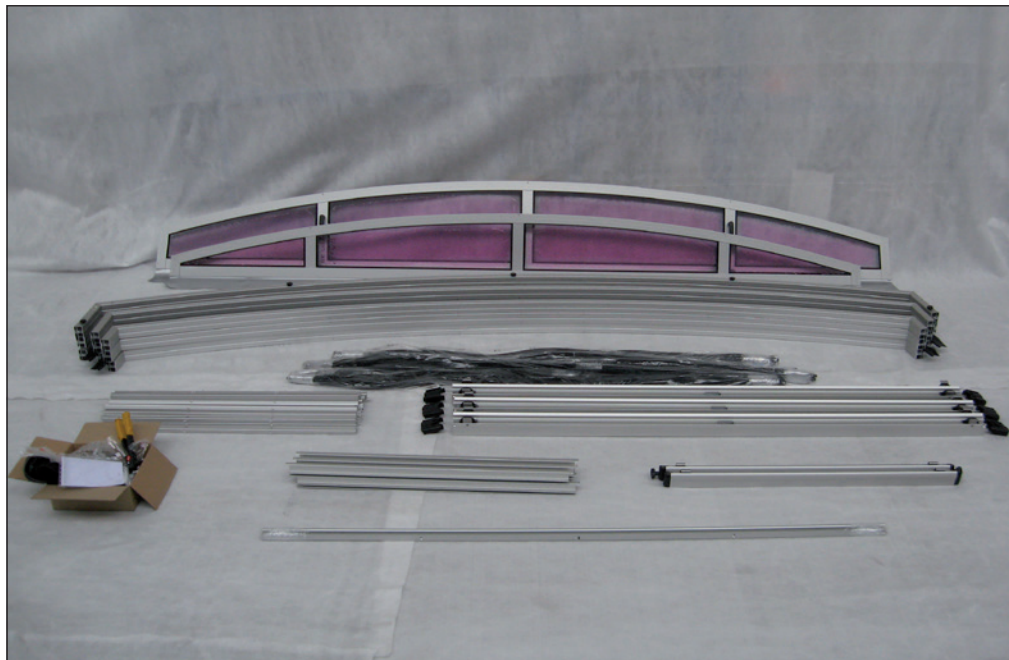

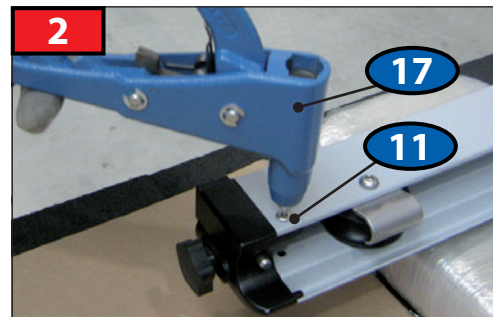
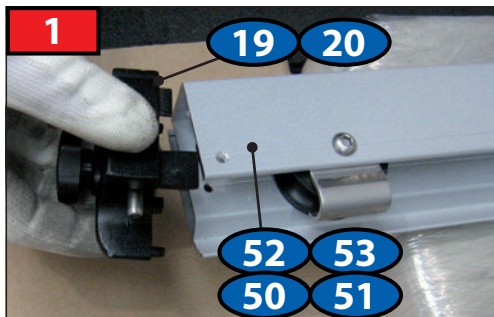
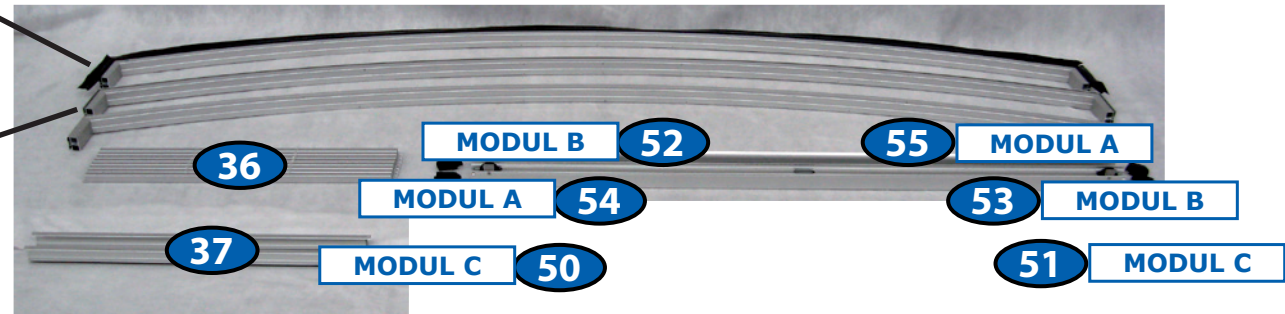
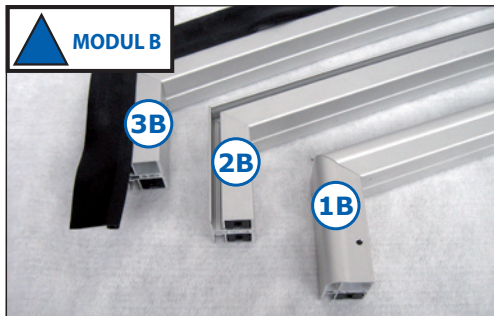
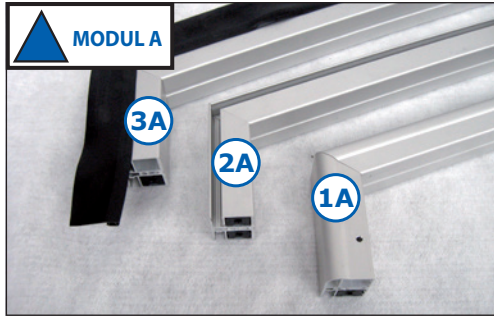
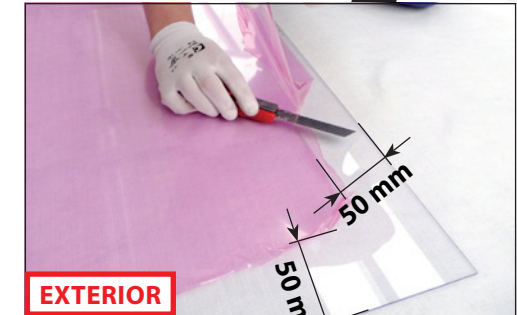
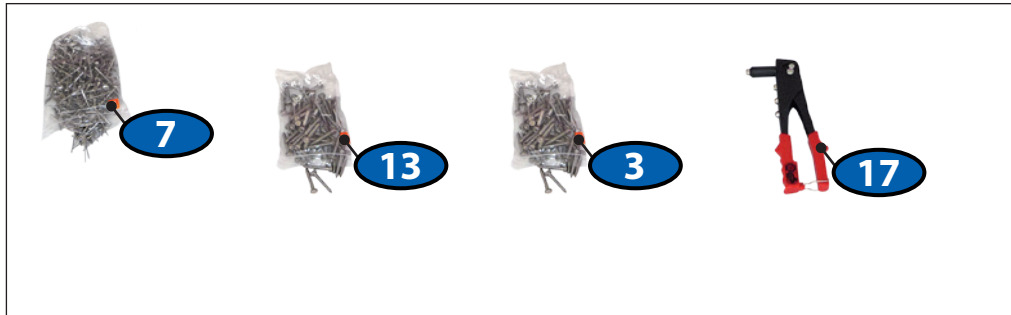

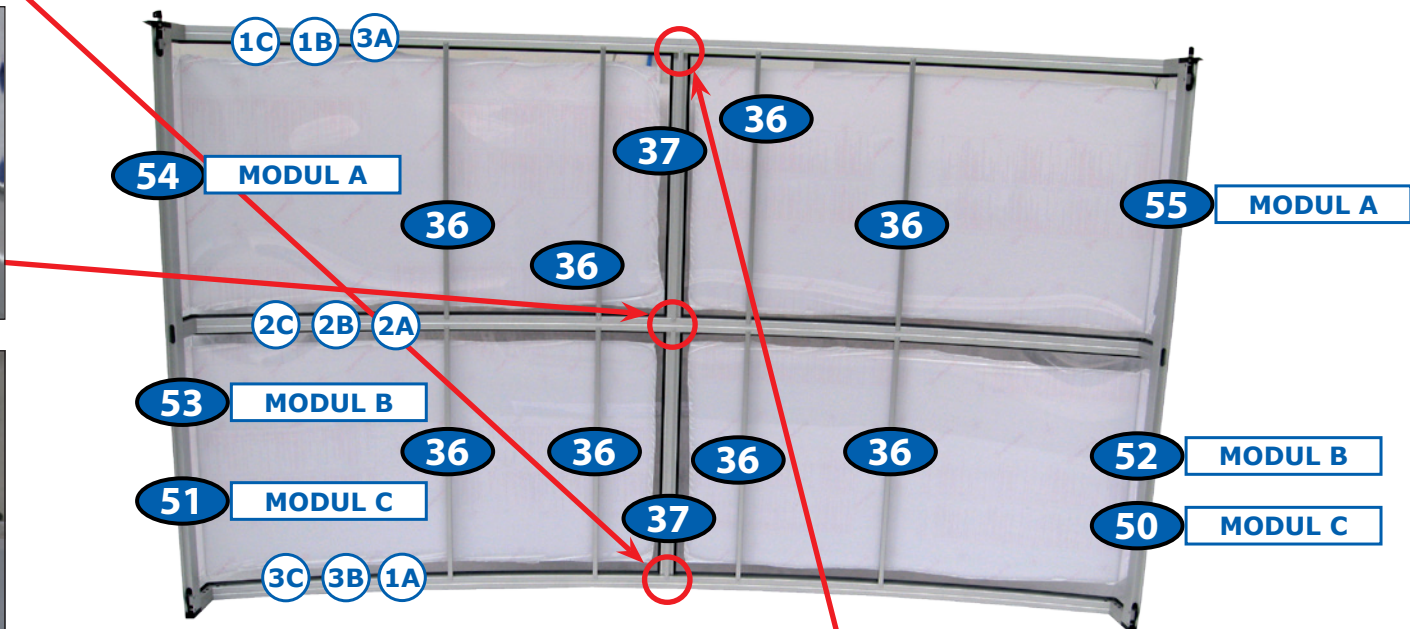
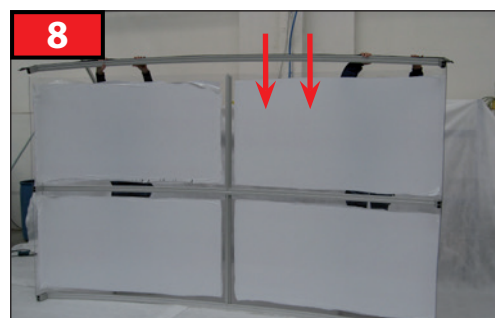
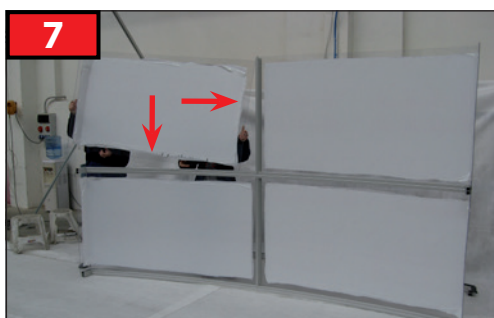
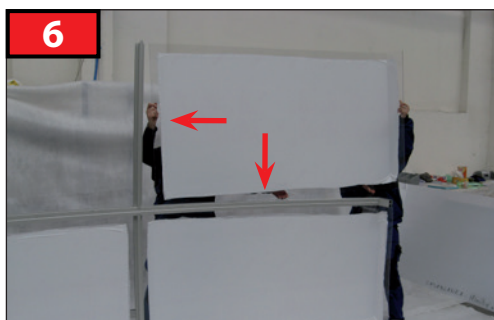
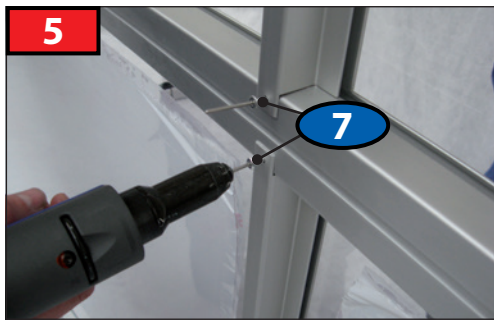
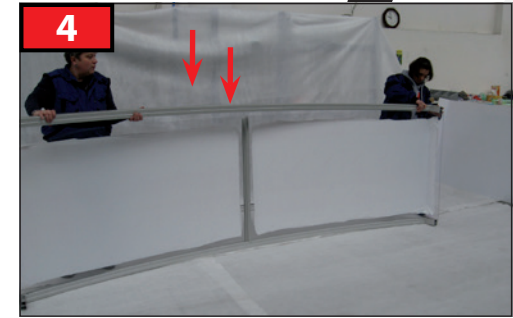
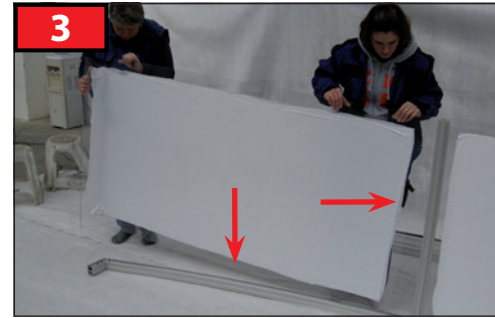
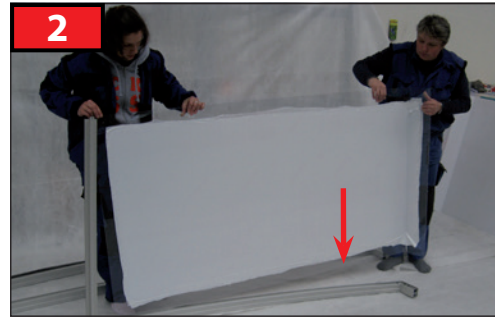
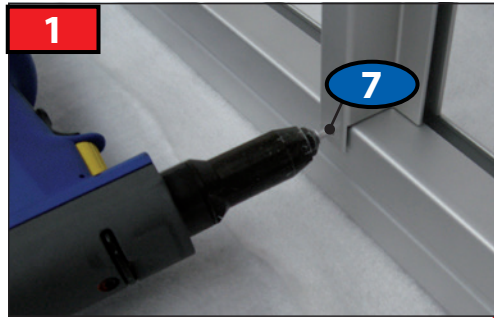

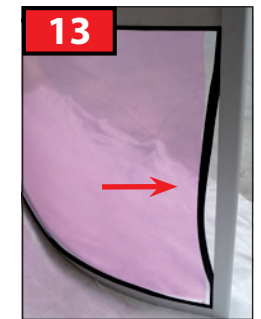
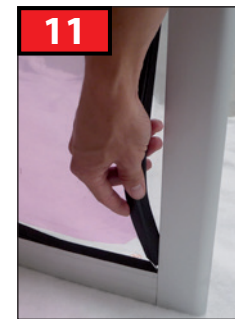
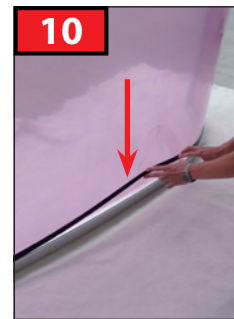
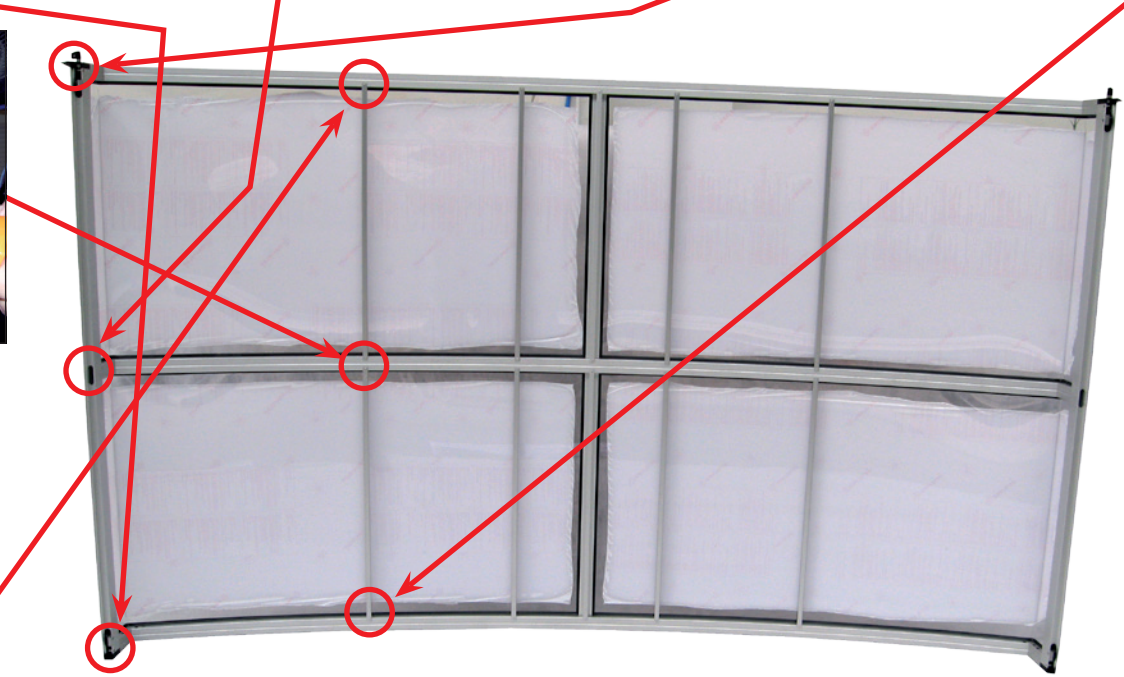
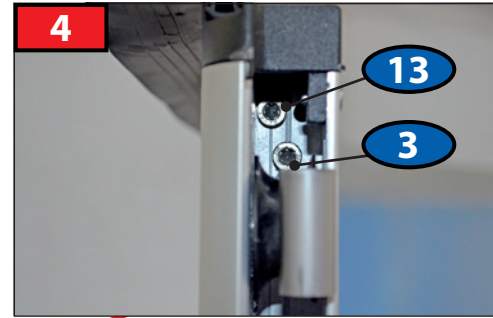
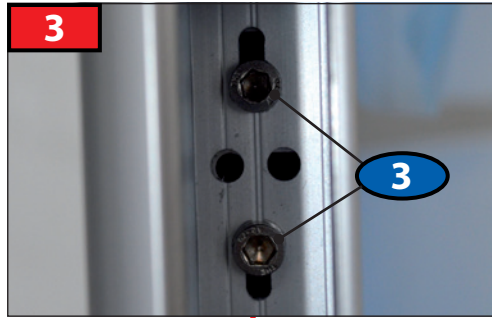
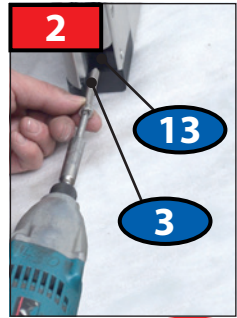

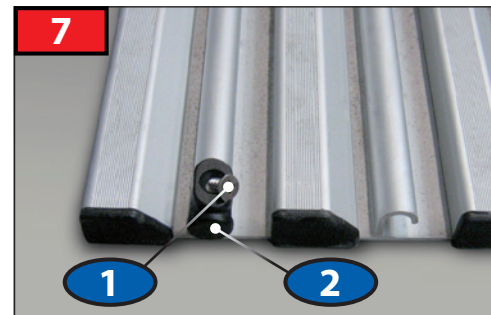
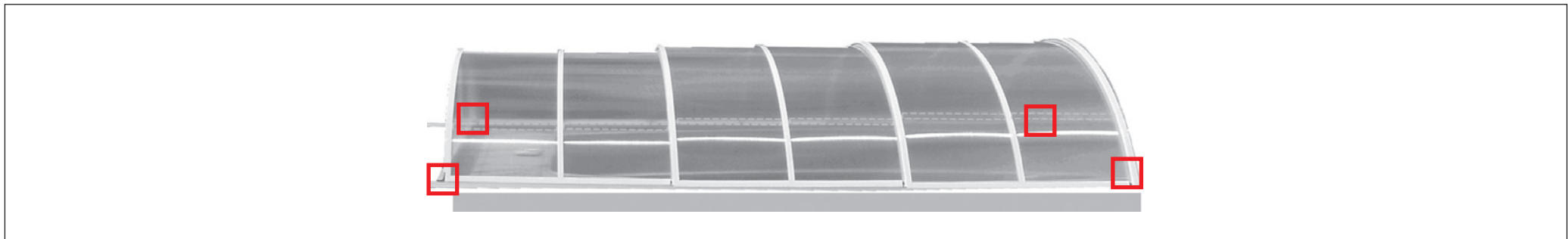
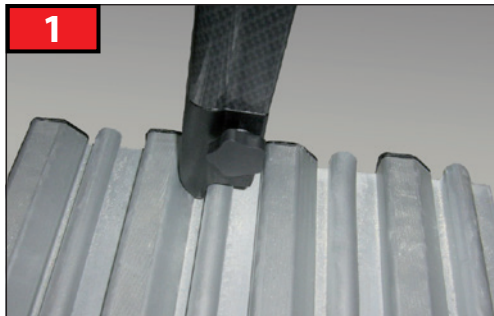
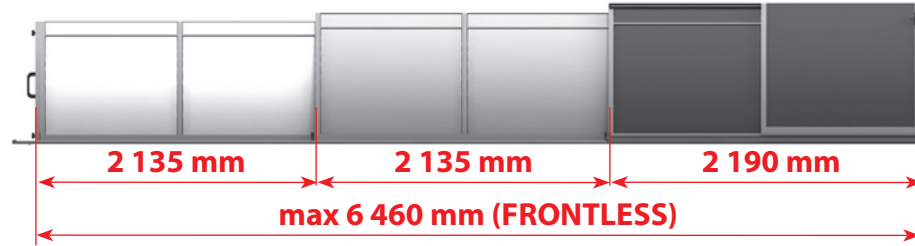

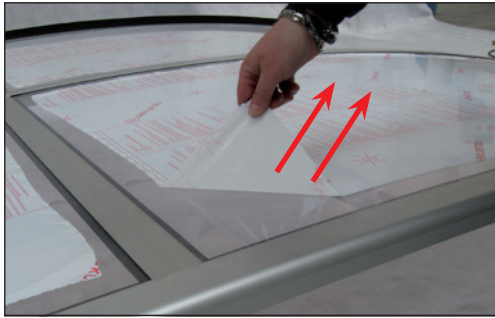
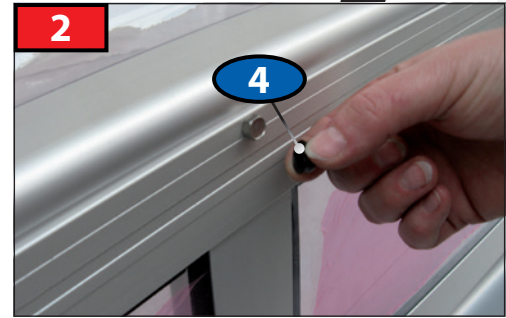
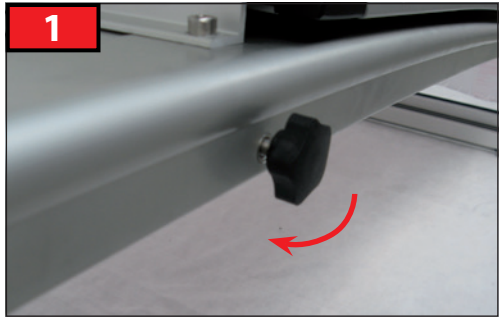

CZ

Dodavatel si vyhrazuje právo na změny a úpravy technických parametrů uváděných v tomto katalogu s ohledem na technický vývoj a zdokonalení výrobků a balení.
Dodavatel si vyhrazuje právo na tiskové chyby a chyby v sazbě.

DE

Der Lieferant behält sich das Recht auf Änderungen und Anpassungen der technischen Parameter, die in diesem Katalog aufgeführt sind, mit Rücksicht auf die technische Entwicklung und Verbesserung der Produkte und Verpackung vor. Der Lieferant behält sich das Recht auf Druckfehler und Fehler im Satz vor.

EN

The supplier reserves the right for modifications and adaptations of the technical parameters stated in this catalogue, considering the technical development and upgrade of the products and packaging. The supplier reserves the right for print errors and typographical errors.

ES

El proveedor se reserva el derecho de hacer cambios y modificaciones técnicas de los parámetros que figuran en este catálogo, con respecto al desarrollo técnico mejorando los productos y embalajes. El proveedor se reserva también el derecho a errores de impresión y composición.

FR

Le fabricant se réserve le droit de modifier les paramètres techniques cités dans ce manuel en considération du développement technique et de l'amélioration des produits et de leur emballage. Le fabricant se réserve le droit des fautes d'impression et de composition.

HU

Gyártó fenntartja jogát a katalógusban feltüntetett műszaki paraméterek változtatására a termékek és csomagolás technikai fejlesztése és tökéletesítése szerint.
Szállító: a szállító fenntartja jogát a nyomtatási és szedési hibákra.

IT

Il fornitore si riserva il diritto di effettuare modifiche e correzioni ai parametri tecnici riportati nel presente catalogo per migliorare e perfezionare dal punto di vista tecnico i prodotti e gli imballaggi. Il fornitore non esclude inoltre l'eventuale presenza di errori di stampa e di impaginazione.

PL

Dostawca zastrzega sobie prawo do zmian oraz dostosowania parametrów technicznych podanych w niniejszym katalogu z uwzględnieniem rozwoju technicznego i udoskonalania produktów oraz opakowań. Dostawca zastrzega sobie prawo do błędów druku oraz typograficznych.

PT

O provedor reserva-se o direito a efectuar alterações e adaptações de parâmetros técnicos mencionados neste catálogo, tendo em consideração o avanço técnico e melhorias de produtos e embalagens. O provedor reserva-se o direito a cometer erros de impressora e de edição.

RO

Furnizorul își rezervă dreptul de a modifica și schimba parametrii tehnici menționați în acest catalog cu privire la evoluția tehnică și perfecționarea produselor și a ambalării. Furnizorul își rezervă dreptul la greșelile de tipar și greșelile privind tarifele.

RU

Поставщик оставляет за собой право на изменение и исправление технических параметров продукции указанной в этом каталоге, с учетом технического развития, а усовершенствования изделий и его упаковки. Поставщик оставляет за собой право на опечатку в тексте и в ценах.