

Lighting & Pool Flow



Certikin Sealed Beam Lights (PU9)



- Slim light and niche
- Threaded conduit on back of niche for easy installation
- Liner and concrete pools
- Clip-on faceplate with liner model
- Vandal proof lens
- Niche designed to angle light (eliminating poolside glare)
- 2.8m, 5m and 8m cable lengths

Complete kit includes:

- Niche
- Flexible conduit
- Cover plate
- Lens cover
- Sealed lamp housing
- 300 Watt bulb
- Transformer



Liner Sealed Beam Light – PU91011NL

Complete Kit

DISCOUNT/ PRODUCT CODE	DESCRIPTION	PRICE EACH
E PU91011NC	Concrete	487.50
E PU91011NC/2	Pack of 2 for Concrete	938.00
E PU91011NL	Liner	515.00
E PU91011NL/2	Pack of 2 for Liner	998.00

Components

DISCOUNT/ PRODUCT CODE	DESCRIPTION	PRICE EACH
E PU9CS	Light & Niche for Concrete (with conduit)	186.00
E PU9LS	Light & Niche for Liner (with conduit)	215.00
E PU10N	Deck Box	20.00
E PU11S	Transformer (300W 12v)	313.00

Guts Pack – 300W 12v

DISCOUNT/ PRODUCT CODE	DESCRIPTION	PRICE EACH
E PU93S	2.8m Cable	147.00
E PU95S	5m Cable	170.00
E PU98S	8m Cable	195.00



Concrete Sealed Beam Light – PU91011NC



Guts Pack – PU93S



Deck Box – PU10N

Certikin Quick Change PU6 Underwater Light



- No tools needed to change the bulb
- Ideal for gunite pools
- Vertical and horizontal cable exit
- Optimal 316 stainless steel ring

Lighting & Pool Flow



Complete Kit with Transformer & Deck

DISCOUNT/ PRODUCT CODE	DESCRIPTION	PRICE EACH
E PU61011C	Concrete	466.00
E PU61011L	Liner	484.00
E EPF353	300W 12v Replacement Bulb with 'O' ring	32.00

Guts Pack – 300W 12v

DISCOUNT/ PRODUCT CODE	DESCRIPTION	PRICE EACH
E PU63	2.8m Cable	114.00
E PU65	5m Cable	132.00
E PU68	8m Cable	163.00
E SPC4756S	Stainless Steel Facia Ring	55.00

Components

DISCOUNT/ PRODUCT CODE	DESCRIPTION	PRICE EACH
E PU6C	Light & Niche for Concrete	160.00
E PU6L	Light & Niche for Liner	172.00
E PU10N	Deck Box	20.00
E PU10NLW	Deck Box with Lid Light – White	60.00
E PU11S	Transformer (300W 12v) IP56, 400 VA	313.00

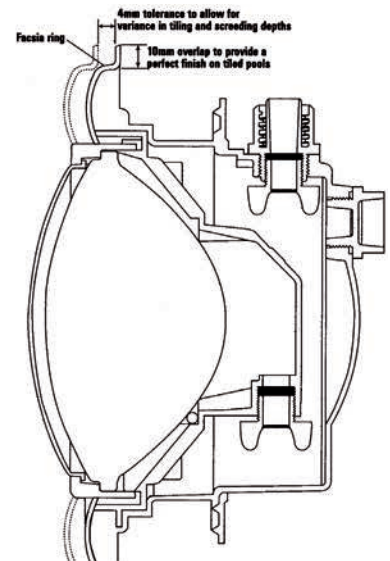
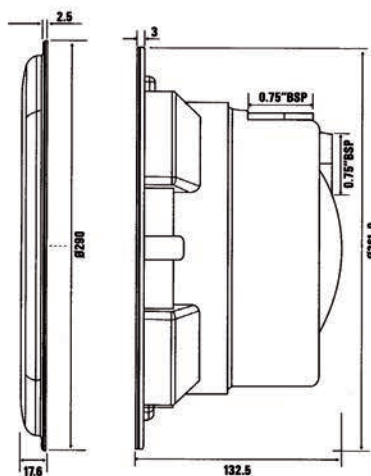
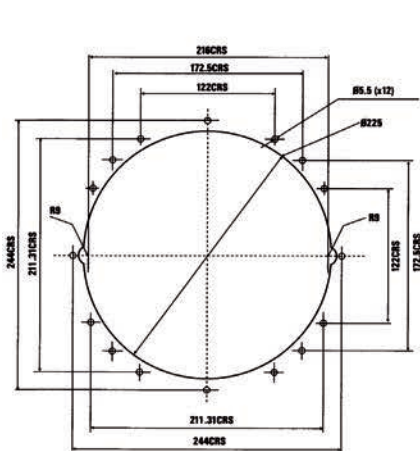

Underwater Lights

- 300 Watt 12 volt sealed beam
- Fixed position
- 3m cable

Fixed Light – EPF272



- 300 Watt 12 volt sealed beam
- Directional fitting
- 3m cable

Directional Light Kit – EPF270



Fixed – Kit

DISCOUNT/ PRODUCT CODE	DESCRIPTION	PRICE EACH
E EPF273	Concrete / Liner c/w Transformer & Deck Box	468.00

Directional – Kit

DISCOUNT/ PRODUCT CODE	DESCRIPTION	PRICE EACH
E EPF270	Concrete / Liner c/w Transformer & Deck Box	480.00

Fixed with Niche

DISCOUNT/ PRODUCT CODE	DESCRIPTION	PRICE EACH
E EPF272	Concrete / Liner	183.00

Directional with Niche

DISCOUNT/ PRODUCT CODE	DESCRIPTION	PRICE EACH
E EPF269	Concrete / Liner	195.00

Accessories

DISCOUNT/ PRODUCT CODE	DESCRIPTION	PRICE EACH
E PU11P	Transformer (300W)	265.65
E PU10N	Deck Box	20.00
K PINT31	Transformer (100W) c/w front mount switch	114.00
K PINT33	Transformer (300W) c/w front mount switch	166.00

Replacement Bulb (300W PAR56)

DISCOUNT/ PRODUCT CODE	DESCRIPTION	PRICE EACH
E EPF353	Sealed Beam suitable Certikin (300W 12v)	32.00



Sealed Beam – EPF353



Deck Box – PU10N



Extra Flat Halogen Light

- Suitable for fitting to wooden or panel pools
- Complete with Junction Box, Transformer and all fittings



Extra Flat Halogen Light – WHL350

Extra Flat Halogen Light

DISCOUNT/ PRODUCT CODE	DESCRIPTION	PRICE EACH
L2 WHL350	Light Kit (100W)	251.00
L2 KRI350	LED Pool Light Kit	251.00
K KRI00001	Replacement Bulb	14.80
K ULT100	100 Watt Transformer	81.00
L2 WHL110	Halogen Pool Light 100W/12v (light and fitting only)	164.00
L2 KRI110	LED Pool Light (light & fitting only)	164.00



Transformer – ULT100



Bulb – KRI00001

Suitable for in-ground and wooden above ground pools. Uses designated or redundant 1.5" return or inlet fitting.

In Ground LED Light (Polycarbonate)

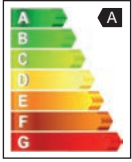

LED011

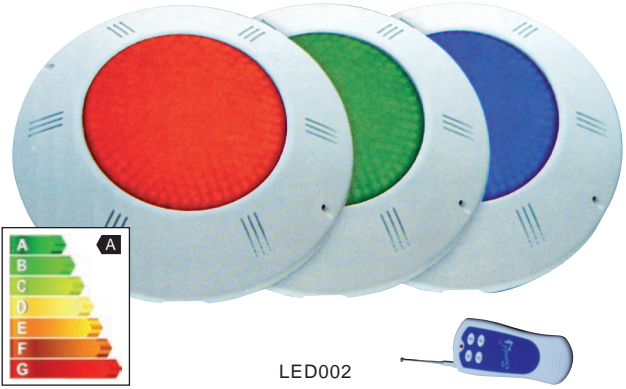
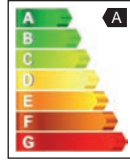

LED002

White

DISCOUNT/ PRODUCT CODE	DESCRIPTION	PRICE EACH
K LED011	White 1450LM* – 24W with remote On/Off (Polycarb.)	266.00
K LED050	Chrome on ABS Fascia Ring	41.50

* Equivalent to 300W 12 volt bulb

- Flat design
- Energy Rating A
- LED011 with remote control

Note: These lights can be used with LED004 or EPF261. A Certikin Inlet can only be used with modification.

RGB

DISCOUNT/ PRODUCT CODE	DESCRIPTION	PRICE EACH
K LED002	RGB (Polycarbonate)	279.00
K LED050	Chrome on ABS Fascia Ring	41.50

- Remote control
- 270 LED's
- 12v 15W
- 11 static colours, 5 colour sequences
- Energy Rating A
- 5 lights can be operated from a single remote

Note: LED011 and LED002 require LED004 and ULT100 for installation

Suitable for in-ground and wooden above ground pools. Uses designated or redundant 1.5" return or inlet fitting.

Above Ground LED Light

- Fixes to inlet
- 216 LED's
- Multi-colour RGB
- 11 static colours, 5 colour sequences
- Remote control can operate up to 5 lights
- 12v 16W
- Energy Rating B

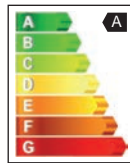

LED Light

DISCOUNT/ PRODUCT CODE	DESCRIPTION	PRICE EACH
K LED005	Above Ground	175.00

Transformer & Deck Box Kit

- For use with LED lights LED002, LED011, WCM15, WCX15

Transformer & Deck Box Kit

DISCOUNT/ PRODUCT CODE	DESCRIPTION	PRICE EACH
K LED004	Kit	68.75
K ULT100	Transformer – 100W	81.00



All LED units are supplied with a two year guarantee

LED PAR56 (Polycarbonate)

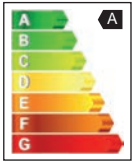

LED006

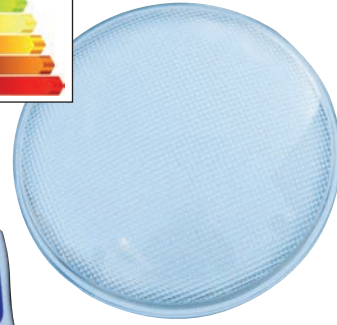
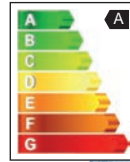

LED007

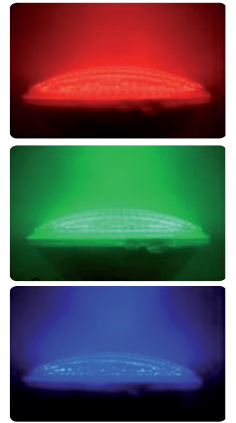

White

DISCOUNT/ PRODUCT CODE	DESCRIPTION	PRICE EACH
K LED016	White 1450LM* – 24W with remote On/Off (Polycarb.)	140.00

- Use to replace existing PAR56 300W bulbs
- Energy Rating A

* Equivalent to 300W 12 volt bulb

RGB

DISCOUNT/ PRODUCT CODE	DESCRIPTION	PRICE EACH
K LED007	RGB (Polycarbonate)	169.50

- 270 LED's
- Use to replace existing PAR56 300W bulbs
- 12v 18W
- Remote control
- 11 static colours, 5 colour sequences
- Energy Rating A

LED PAR56 (Glass)

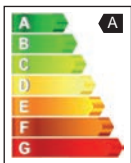

LED006G

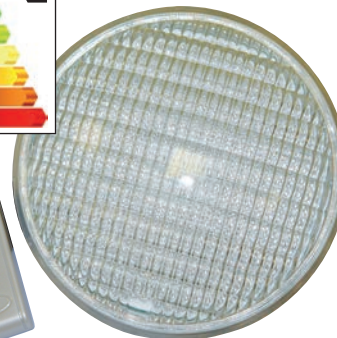
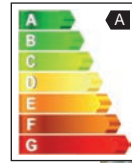

LED007G

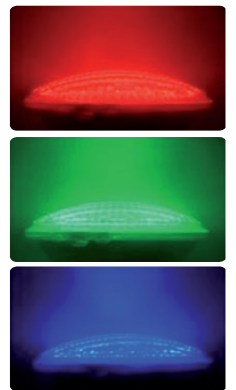

White

DISCOUNT/ PRODUCT CODE	DESCRIPTION	PRICE EACH
K LED006G	White (Glass)	96.00

- Use to replace existing PAR56 300W bulbs
- 12v 12W
- 252 white LED's

RGB

DISCOUNT/ PRODUCT CODE	DESCRIPTION	PRICE EACH
K LED007G	RGB (Glass) with remote	160.00

- Use to replace existing PAR56 300W bulbs
- 12v 12W
- 252 RGB LED's

NB: For multiple/paired RGB lights we recommend WEM 30 with Brio controller for flawless synchronisation.
For advice phone Jody 01424 857743

All PAR56 bulbs are suitable replacements for Certikin or Plastica lights.

Eolia Light



White

DISCOUNT/ PRODUCT CODE	DESCRIPTION	PRICE EACH
K WEM20	White PAR 56 LED Light – 25W (1450lm)	114.00
K WEM40	White PAR 56 LED Light – 40W (4400lm)	171.00

- Standard PAR 56 LED bulb to fit any PAR 56 niche
- 20W/40W in white; up to 4400lm
- Ideal for new installations or refurbishments
- Low power consumption and good luminosity

RGBW

DISCOUNT/ PRODUCT CODE	DESCRIPTION	PRICE EACH
K WEM30	RGBW PAR 56 LED Light – 36W (1150lm)	252.00

- Standard bulb with two-points connection on the back
- 36W in RGB+W, 1150lm
- The two connections on the back makes installation simple, compared to 4/6-wires systems
- Can be used with BRIO remote synchronisation kits
- Ideal for multiple installations

Chroma Universal Light

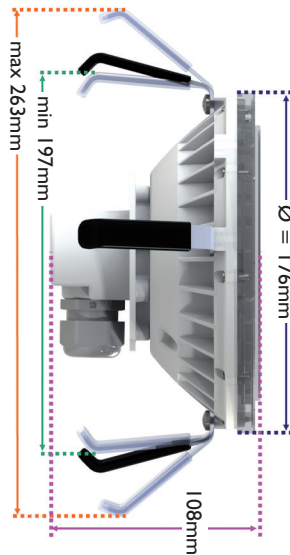

White

DISCOUNT/ PRODUCT CODE	DESCRIPTION	PRICE EACH
K WCM20	White LED Light – 20W	201.00
K WCM40	White LED Light – 40W	231.00
K BAHIA	SS Bezel 316L 3mm thin for concrete pools	122.00
K NOVA	SS Bezel 316L for liner pools	122.00

- Adjustable to fit most underwater light niches
- 3m cable supplied
- 20W = 1450 lumens 40W - 2100 lumens
- Bezel 260mm diameter

RGBW

DISCOUNT/ PRODUCT CODE	DESCRIPTION	PRICE EACH
K WCX30	RGBW Light with white flange – 36W	317.00
K BAHIA	SS Bezel 316L 3mm thin for concrete pools	122.00
K NOVA	SS Bezel 316L for liner pools	122.00

- Adjustable to fit most underwater light niches
- 3m cable supplied
- Remote synchronisation kit available (see page 24) One kit works up to three lights
- Bezel 260mm diameter

Mini Chroma Light



White

DISCOUNT/ PRODUCT CODE	DESCRIPTION	PRICE EACH
K WCM15	White LED Mini Light – 15W 103mm Ø	116.00
K MINIBAHIA SS Bezel 316L extra thin for concrete pools 96mm Ø		53.60
K MININOVA SS Bezel 316L for liner pools 106mm Ø		53.60

- Screws in to most designated 1.5" inlets (not Certikin)
- 2.5m pre-wired cable supplied
- 700 lumens

RGBW

DISCOUNT/ PRODUCT CODE	DESCRIPTION	PRICE EACH
K WCX15	RGBW LED Mini Light – 15W 103mm Ø	191.00
K MINIBAHIA SS Bezel 316L extra thin for concrete pools 96mm Ø		53.60
K MININOVA SS Bezel 316L for liner pools 106mm Ø		53.60

- Screws in to most 1.5" designated inlets (not Certikin)
- 2.5m pre-wired cable supplied
- Remote synchronisation kit available (see below)
One kit works up to three lights

Transformer, Synchronisation & Deck Box Kit

Transformer, Synchronisation & Deck Box

DISCOUNT/ PRODUCT CODE	DESCRIPTION	PRICE EACH
K LED004	Deck Box Kit	68.75
K ULT100	Transformer – 100W	81.00
K BRIO-RC	RGB Synchronisation panel (up to 3 lights)	122.00
K BRIO100-RC	RGB Synchronisation Panel with 100W Transformer	201.00
K BRIO300-RC	RGB Synchronisation Panel with 300W Transformer	379.00
K BRIO300-RC+	RGB Synchronisation Panel for Smart phone APP	228.00
K PF10R192	Mini Chroma Niche for c/w backnut	35.00

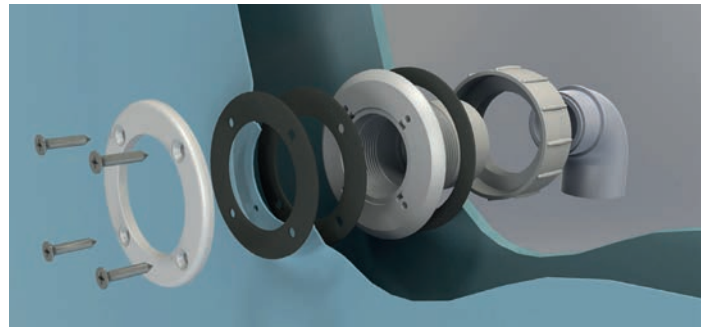

Mini Chroma Niche



Certikin Auto Top-up

- 1.5" female thread BSP
- Female thread 1.5" outlet
- Some authorities require a non-return valve

Auto Top-up

DISCOUNT/ PRODUCT CODE	DESCRIPTION	PRICE EACH
E HD108	Certikin	138.50



- Robust one piece body
- Through the wall design
- Overflow and water fill outlets provided
- Extending collar and square frame for easy installation
- For both liner and concrete pools
- Wide angle and parallel throat
- Flap or collar weir models
- Maximum flow is 4.5m³ per hour
- Adjustable flow restrictor
- Optional extension throats allow the skimmer to be positioned any distance from the pool wall

Lighting & Pool Flow

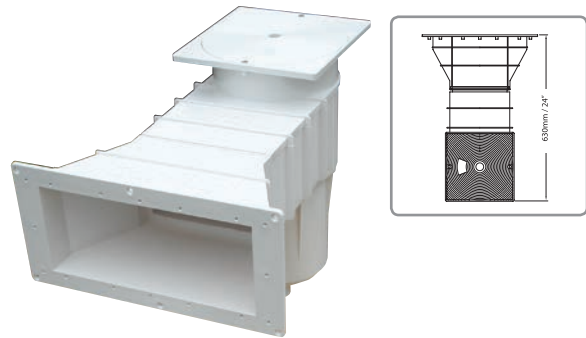

Liner Weir Type – HD1001SLS

Concrete Weir Type

DISCOUNT/ PRODUCT CODE	DESCRIPTION	PRICE EACH
E HD100SN	Skimmer Collar Weir	123.00
E HD1001SCS	Collar Weir Wide Angle Extension Throat (Plumbed)	167.00

Liner Weir Type

DISCOUNT/ PRODUCT CODE	DESCRIPTION	PRICE EACH
E ZZ0259	Skimmer (inc. HDLAK)	152.00
E HD1001SLS	Collar Weir Wide Angle Extension Throat (Plumbed)	176.00

Skimmer Accessories

DISCOUNT/ PRODUCT CODE	DESCRIPTION	PRICE EACH
E HD105	Skimmer Conversion Kit (Flap to Collar Weir)	26.85
E HD103	Vacuum Kornea	11.70
K HD100LAK	Skimmer Adaptor Kit	29.95

Concrete Extension Throats

DISCOUNT/ PRODUCT CODE	DESCRIPTION	PRICE EACH
E HD102	Parallel Extension	35.35
E HD101CS	Wide Angle Extension	40.50
E HD101CS+B	Wide Angle Extension (Black)	73.00
E HD101CS+G	Wide Angle Extension (Grey Metallic)	73.50

Liner Extension Throats

DISCOUNT/ PRODUCT CODE	DESCRIPTION	PRICE EACH
E HD102LN	Parallel Extension + Liner Adaptor Kit	60.25
E HD101LT	Wide Angle Extension	52.50
E HD101LS+B	Wide Angle Extension (Black)	89.00
E HD101LS+G	Wide Angle Extension (Grey Metallic)	89.00
S SPC4031	2" Lid Frame Extender	13.00

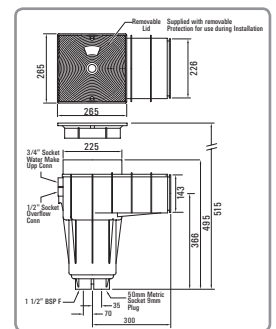

Concrete Weir Type – HD100SN
Adjustable flow restrictor for bottom connection

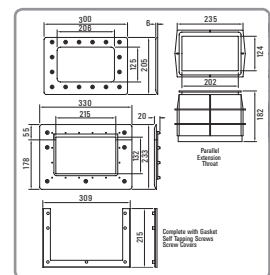
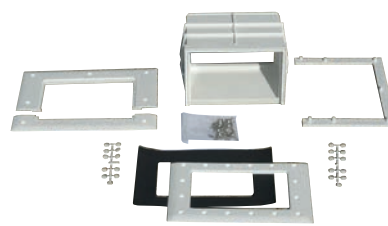

Liner Extension Throats – HD102LN

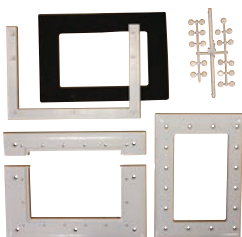

Adapter Kit – HD100LAK



Wide Extension – HD101LS



Conversion Kit – HD105



Vacuum Kornea – HD103

Poolskim

- Continuous skimming whilst cleaner is in use
- Attaches to return
- No booster pump required
- Self adjusts to water level
- Works in conjunction with suction cleaner
- Easy to clean
- Re-usable clip-on bag
- Reduces pump workload
- For above ground or in-ground pools

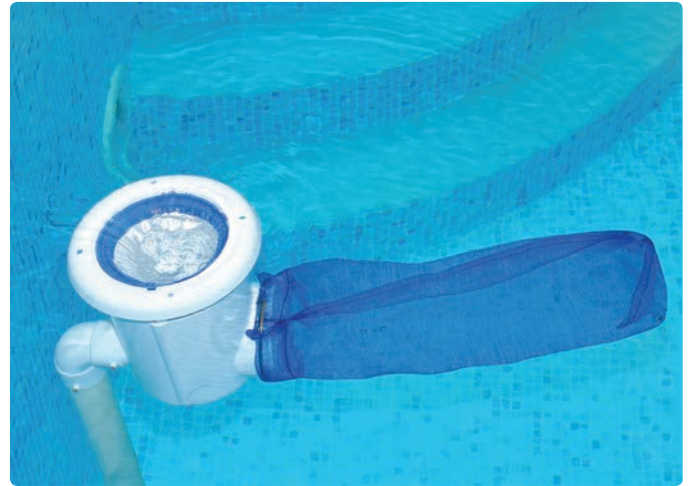

Poolskim

DISCOUNT/ PRODUCT CODE	DESCRIPTION	PRICE EACH
K PSK100	Poolskim	59.00
K PSK001	Replacement Nets with Clip	11.30

Intex Above Ground Pool Skimmer

- Mounts to Easy Set or Metal Frame Pool with adjustable bracket
- Attached to filter pump for automatic skimming
- Strainer basket pulls out for easy cleaning
- Requires Intex pump with minimum flow rate of 3,000 litres per hour



Skimmers

DISCOUNT/ PRODUCT CODE	DESCRIPTION	PRICE EACH
L 28000/E	Wall Mount Surface	26.50

Above Ground Pool Skimmer & Inlet

Standard

DISCOUNT/ PRODUCT CODE	DESCRIPTION	PRICE EACH
L ENS100	Standard Skimmer & Inlet	38.00

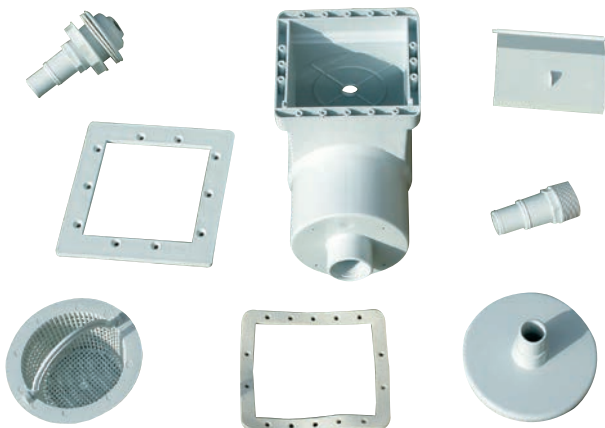

Wide Angle

DISCOUNT/ PRODUCT CODE	DESCRIPTION	PRICE EACH
L ENS110	Wide Angle Skimmer & Inlet	48.00

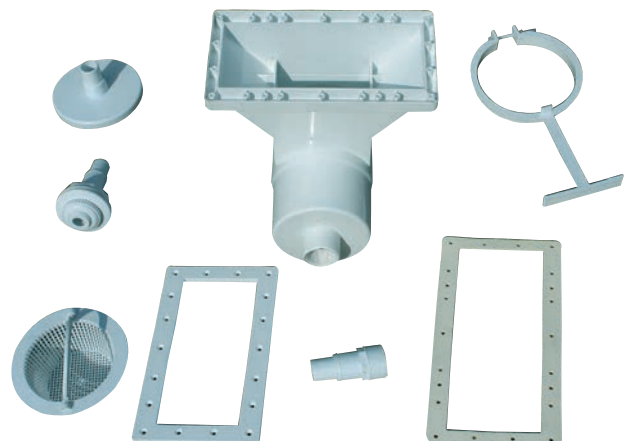

Netskim®

- Reduce the need to clean skimmer baskets
- Captures debris
- Less frequent cleaning of the filter pump basket
- Easier pool maintenance
- High protection of the pump and all the equipment
- Display Box = 36 individual boxes containing 12 pieces



Netskim®

DISCOUNT/ PRODUCT CODE	DESCRIPTION	PRICE EACH
K NET001	Box of 12	12.60
K NET036	Display Box of 36 boxes	446.00

Skimmer Socks

- Reduce the need to clean skimmer baskets
- Easier pool maintenance
- High protection of the pump and all the equipment

Skimmer Socks

DISCOUNT/ PRODUCT CODE	DESCRIPTION	PRICE EACH
K SKS001	Skimmer Socks (box of 12)	7.50



Water Lily®

- Absorbs oils and creams
- Protection of the waterline
- Purification of the surface water
- Absorbing action until saturation
- Display box = 36 individual boxes containing 6 pieces each

Water Lily®

DISCOUNT/ PRODUCT CODE	DESCRIPTION	PRICE EACH
K WLL001	Water Lily	9.60
K WLL036	Display box of 36 boxes	345.60

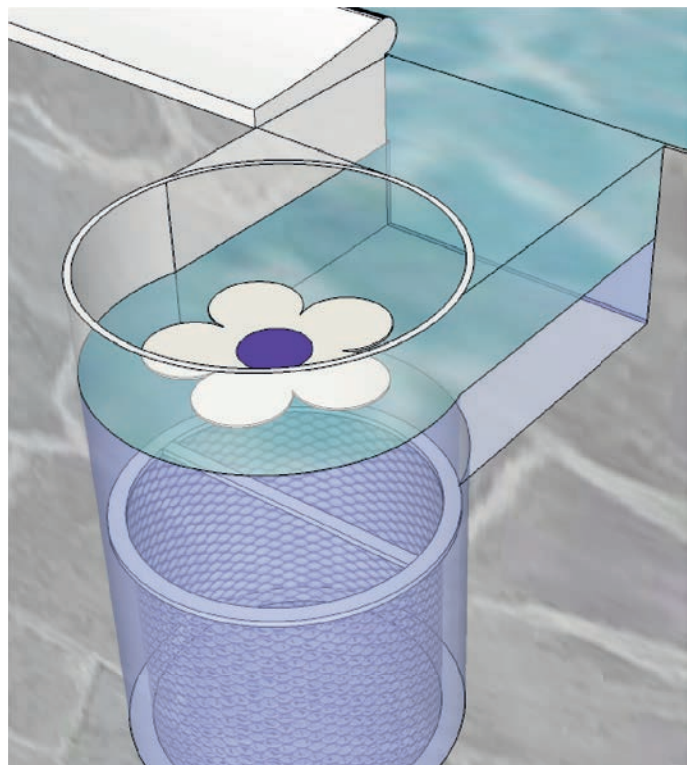
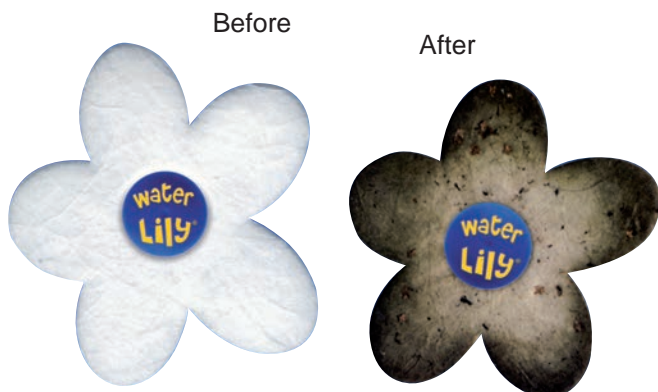

Certikin Main Drain



Made in the UK

Concrete

DISCOUNT/ PRODUCT CODE	DESCRIPTION	PRICE EACH
E HD33	6" with Anti-Vortex Grille (White)	30.25
E HD33C+B	6" with Anti-Vortex Grille (Black)	55.50
E HD33C+G	6" with Anti-Vortex Grille (Metallic Grey)	55.50

Liner

DISCOUNT/ PRODUCT CODE	DESCRIPTION	PRICE EACH
E HD33LT	6" with Anti-Vortex Grille (White)	39.75
E HD33L+B	6" with Anti-Vortex Grille (Black)	72.00
E HD33L+G	6" with Anti-Vortex Grille (Metallic Grey)	73.00

Accessories

DISCOUNT/ PRODUCT CODE	DESCRIPTION	PRICE EACH
E HD34	Hydro Relief Valve – ABS (1.5")	12.30
E CK34S	Hydro Relief Valve – Brass (1.5")	74.10
E HD35	Collection Tube (1.5")	7.65
E CK33S	Main Drain Grille – Stainless Steel	52.00
K SPC266N	High Flow Low Velocity ABS Grille	22.00

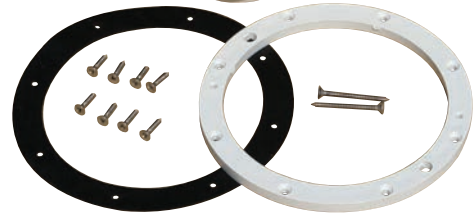

Main Drain – HD33L



ABS Hydro Relief Valve – HD34



Brass Hydro Relief Valve – CK34S



Black Main Drain – HD33C+B



Met Grey Main Drain – HD33C+G



Collection Tube – HD35



Stainless Steel Grille – CK33S

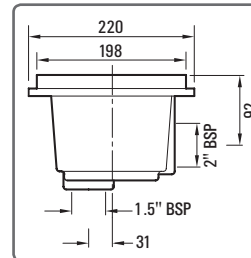

Concrete

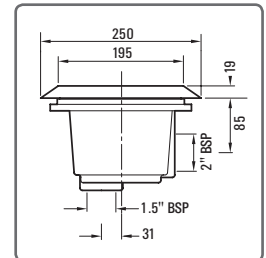

Liner

Certikin Inlets

1.5" & 2" Concrete

DISCOUNT/ PRODUCT CODE	DESCRIPTION	PRICE EACH
E HD54C/5	Fixed Grate (1.5") 5No.	47.50
E ZHD54C	Plumbed Fixed Grate - Low Suction (1.5") Single	22.95
E HD5015	Adjustable (1.5") Single	9.95
E HD502	Adjustable (2") Single	11.30
E HD55/2	Non Leak Flange (Puddle Flange) 250mm	29.40



Non Leak Flange – HD55/2



Adjustable Inlet – HD5015



Back Nut – SPC493

Certikin Inlets



Made in the UK

Lighting & Pool Flow

1.5" Liner

DISCOUNT/ PRODUCT CODE	DESCRIPTION	PRICE EACH
E HD54LT/5	Fixed Grate without Back Nut 5no.	86.00
E HD54LS+B	Fixed Grate - Low Suction Black Single	35.00
E HD54LS+G	Fixed Grate - Low Suction Grey Metallic Single	35.00
E ZHD54LT	Plumbed Fixed Grate - Low Suction Single	29.50
E HD54PLT/5	Fixed Grate for Panel Pool with Back Nut 5no.	114.00
K SPC493	Back Nut Single	7.71



Fixed Grate – HD54L

1.5" Liner Eyeball

DISCOUNT/ PRODUCT CODE	DESCRIPTION	PRICE EACH
E HD53LT/5	Eyeball without Back Nut 5no.	86.00
E HD53LS+B	Eyeball Black Single	35.00
E HD53LS+G	Eyeball Grey Metallic Single	35.00
E ZHD53LT	Plumbed Eyeball Single	29.75
E HD53PLT/5	Panel Pool with Back Nut 5no.	114.00
K SPC493	Back Nut	7.71



Black Fixed Grate – HD54LS+B



Met Grey Fixed Grate – HD54LS+G

1.5" Concrete

DISCOUNT/ PRODUCT CODE	DESCRIPTION	PRICE EACH
E HD53C/5	Eyeball 5no.	51.00
E HD53C+B	Eyeball Black Single	20.20
E HD53C+G	Eyeball Grey Metallic Single	20.45
E ZHD53C	Plumbed Eyeball Single	23.45
E HD54C/5	Fixed Grate 5no.	47.50



Eyeball – HD53L



Fixed Grate with Back Nut – HD54PL



Eyeball – HD53PL



Fixed Grate – HD54C



Black Eyeball – HD53LS+B



Met Grey Eyeball – HD53LS+G

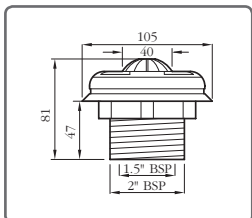

HD54L

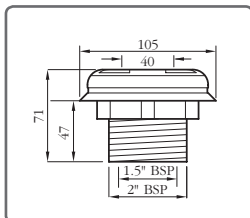

HD53L

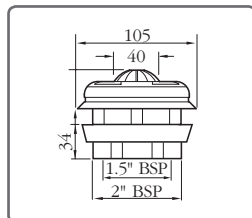

HD54PL

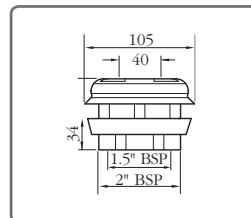

HD53PL

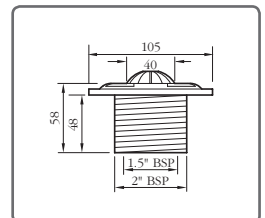

HD54C

Certikin Vacuum Points



Lighting & Pool Flow

1.5" Concrete

DISCOUNT/ PRODUCT CODE	DESCRIPTION	PRICE EACH
E HD20/5	with Plug (White) 5No.	41.60
E HD20C+B	with Plug (Black) Single	20.45
E HD20C+G	with Plug (Grey Metallic) Single	20.45
E ZHD20C	with Plumbed Pipe approx 550mm (White) Single	24.10

1.5" Liner

DISCOUNT/ PRODUCT CODE	DESCRIPTION	PRICE EACH
E HD20LT/5	with Plug (White) 5No.	85.00
E HD20LS+B	with Plug (Black) Single	37.50
E HD20LS+G	with Plug (Grey Metallic) Single	37.50
E ZHD20LT	with Plumbed Pipe approx 550mm (White) Single	34.00
E HD20PLT/5	for Panel Pool (White) 5No.	97.60

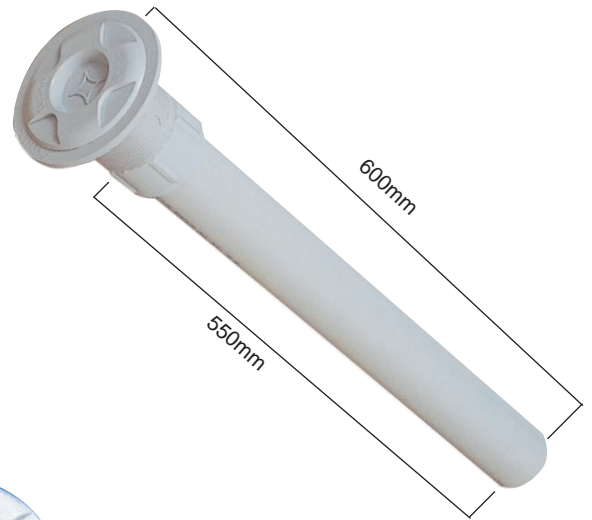

Plumbed Vacuum Point – ZHD20L



Vacuum Point – HD20



Vacuum Point – HD20L



Vacuum Point – HD20C+B



Vacuum Point – HD20C+G

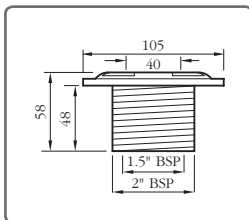

HD20

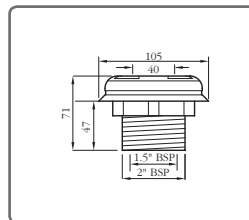

HD20L

Inlet & Vacuum Point Kit

- 250mm no-leak flange
- Combined directional inlet or Vacuum Point
- Vacuum Plate
- 2" MT/1.5" Glue (Liner)

Inlet & Vacuum Point Kit

DISCOUNT/ PRODUCT CODE	DESCRIPTION	PRICE EACH
E EPF261	Inlet and Vacuum Point Kit	17.90
E 42000000	Liner Inlet with 50mm F/P Connection*	21.00
K PPF100	50mm-1.5" reducer	1.53

(required with above inlet for 1.5" pipe)



Liner Inlet with 50mm – 42000000



Inlet and Vacuum Point Kit – EPF261

* The above inlet is useful when fitting mini Chroma Lights

Flow Switch

- 1.5" slip fit

Flow Switch

DISCOUNT/ PRODUCT CODE	DESCRIPTION	PRICE EACH
K 1970	25 Amp Flow Switch	138.00

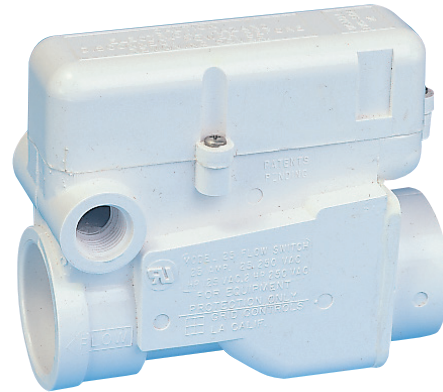

Pipe Repair / Connectors

- A – 1.5" Pipemate glues inside 1.5" pipe to extend it by 30mm
- B – 2" Pipemate glues inside 2" pipe to extend it by 45mm
- C – 1.25"/1.5" female 1.5" plain hosetail
- D – 1.25"/1.5" male 1.5" plain hosetail

- C and D can connect together to make a vac hose/backwash hose connector for 1.25"/1.5" hose.

Pipe Repair / Connectors

DISCOUNT/ PRODUCT CODE	DESCRIPTION	PRICE EACH
K FPF160	1.5" Pipemate (A)	1.90
K FPF260	2" Pipemate (B)	2.70
K FPF165	1.25"/1.5" female 1.5" plain hosetail (C)	2.30
K FPF170	1.25"/1.5" male 1.5" plain hosetail (D)	2.30

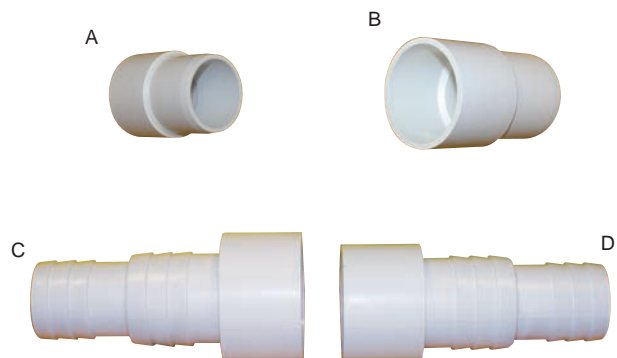

Flexfit Pipe System

- For plumbing between pool and concrete filtration base
- Reduces the number of fittings required
- PVC hose bends to the shape of the pool

- Quicker and simpler to use

Lighting & Pool Flow



Tee Piece Comp/Comp/Comp



Tee Piece Comp/FP/FP



90° Comp/Comp



90° Comp/FP



90° Comp/MT



Socket Comp/FP



Socket Comp/MT



Socket Comp/MP



Socket Comp/Comp

50mm

DISCOUNT/ PRODUCT CODE	DESCRIPTION	PRICE EACH
K FPF105	25m Roll of Flexfit Pipe	125.25
K FPF110	Tee Piece (Comp - Comp - Comp)	21.30
K FPF115	Tee Piece (Comp - 1.5" F/P - 1.5" F/P)	9.20
K FPF120	90° (Comp - Comp)	14.00
K FPF125	90° (Comp - 1.5" F/P)	8.70
K FPF130	90° (Comp - 1.5" M/T)	8.70
K FPF135	Socket (Comp - 1.5" F/P)	8.70
K FPF140	Socket (Comp - 1.5" M/T)	9.70
K FPF145	Socket (Comp - 1.5" M/P)	8.30
K FPF150	Socket (Comp - Comp)	14.00
K FPF155	Installation Key	2.90

Adaptors

DISCOUNT/ PRODUCT CODE	DESCRIPTION	PRICE EACH
K FPF001	1.5" M/P - 50mm F/P Adaptor*	3.70
K FPF002	1.5" F/P - 50mm F/P Straight Connector**	4.20
K FPF003	50mm - 50mm Straight Connector***	4.30

*For connecting Flexfit pipe to a socket

**For connecting Flexfit pipe to 1.5" ABS pipe

***For connecting Flexfit pipe to Flexfit pipe

63mm

DISCOUNT/ PRODUCT CODE	DESCRIPTION	PRICE EACH
K FPF205	25m Roll of Flexfit Pipe	181.75
K FPF210	Tee Piece (Comp - Comp - Comp)	32.00
K FPF220	90° (Comp - Comp)	23.00
K FPF225	90° (Comp - 2" F/P)	15.00
K FPF235	Socket (Comp - 2" F/P)	12.80
K FPF240	Socket (Comp - 2" M/T)	13.00
K FPF245	Socket (Comp - 2" M/P)	12.60
K FPF250	Socket (Comp - Comp)	23.00
K FPF255	Installation Key	2.50



Installation Key

Please note: Flexfit Pipe and fittings are not suitable for use on automatic pool cleaner pressure lines.

Flexible Rubber Connectors

- Reduce stress and vibration
- Ideal for pipe repairs and for use as temporary fittings
- Removable and re-usable
- Supplied with stainless steel clips

Rubber Connectors

DISCOUNT/ PRODUCT CODE	DESCRIPTION	PRICE EACH
K FRC005	1.5" Flexible Rubber Connector	3.75
K FRC010	2" Flexible Rubber Connector	4.00
K FRC015	2" to 1.5" Flexible Rubber Reducing Connector	4.00
K FRC020	1.5" Flexible Rubber Bend	8.00
K FRC025	2" Flexible Rubber Bend	8.90
K FRC030	1.5" Flexible Rubber Tee	9.50
K FRC035	2" Flexible Rubber Tee	10.80
K FRC040	1.5" Flexible End Cap	2.30
K FRC045	2" Flexible End Cap	2.50

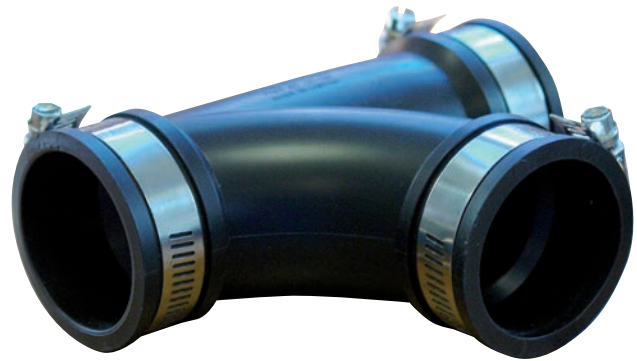

Lighting &
Pool Flow

45 YEARS  **Plastica**

Looking for competitive Lighting & Pool Flow prices?
Why not contact us **NOW**

 01424 857857

 01424 875858

 info@plasticapools.net

 www.plasticapools.net

Find us on     

Class C Pipe

DISCOUNT/ PRODUCT CODE	DESCRIPTION	NO. IN PACK	PRICE EACH
C PPF1015	1.5" x 3m	5	92.10
C PPF1038	1.5" x 1.5m	8	74.90
C PPF0015	1" x 3m	5 (MOQ)	49.50

Sockets

DISCOUNT/ PRODUCT CODE	DESCRIPTION	NO. IN PACK	NO. IN BOX	PRICE EACH
C PPF10510	P/P (A)	10	500	19.30
C PPF105C10	Socket Reducer P/P 50mm – 1.5"	10	500	27.50
C PPF10610	P/FT (B)	10	500	28.90

T Joint & Elbows

DISCOUNT/ PRODUCT CODE	DESCRIPTION	NO. IN PACK	NO. IN BOX	PRICE EACH
C PPF10710	'T' Joint P/P/P (C)	10	200	33.60
C PPF10810	90° Elbow P/P (D)	10	250	19.90
C PPF10910	45° Elbow P/P (E)	10	360	21.40

Nipples

DISCOUNT/ PRODUCT CODE	DESCRIPTION	NO. IN PACK	NO. IN BOX	PRICE EACH
C PPF11010	Socket Nipple P/MT (F)	10	960	19.90
C PPF11110	Nipple MP/MT (G)	10	500	20.20

Unions

DISCOUNT/ PRODUCT CODE	DESCRIPTION	NO. IN PACK	NO. IN BOX	PRICE EACH
C PPF1125	Socket Union P/P (H)	5	400	38.40
C PPF1135	Socket Union P/MT – 50mm length (J)	5	360	37.00
C PPF1365	Socket Union P/MT – 30mm length (K)	5	400	38.60
C PPF1335	Socket Union P/FT (L)	5	400	39.10
C PPF115	Composite Union P/MT	1	10	26.50
C PPF116	Composite Union P/FT	1	10	26.40

Hosetails

DISCOUNT/ PRODUCT CODE	DESCRIPTION	NO. IN PACK	NO. IN BOX	PRICE EACH
C PPF12110	Plain (Q)	10	700	14.90
C PPF13810	Plain – 65mm length (Q)	10	500	17.30
C PPF12210	Threaded – 50mm length (R)	10	700	17.70
C PPF13710	Threaded – 65mm length (R)	10	500	17.60

Reducers

DISCOUNT/ PRODUCT CODE	DESCRIPTION	NO. IN PACK	NO. IN BOX	PRICE EACH
K PPF100	50mm – 1.5" reducer (T)	1	1	1.56
C PPF12310	2" – 1.5" Threaded – 50mm length (S)	10	500	24.20
C PPF12410	2" – 1.5" Plain (T)	10	700	19.50
C PPF32510	63mm – 50mm Plain (MOQ 50 packs)	10	500	18.20
C PPF32610	2" – 50mm Plain (MOQ 50 packs)	10	500	18.20
C PPF32710	63mm – 1.5" Plain (MOQ 50 packs)	10	500	18.20

Miscellaneous

DISCOUNT/ PRODUCT CODE	DESCRIPTION	NO. IN PACK	NO. IN BOX	PRICE EACH
C PPF11410	End Cap Plain	10	500	24.50
C PPF11710	Threaded Plug (M)	10	1000	15.10
C PPF11810	MP/FT Adaptor (N)	10	500	24.40
C PPF11950	Pipe Clip (P)	50	1500	68.30
E PPF120	Double Union Ball Valve	1	24	20.00
* PPF296	1.25" Threaded Hosetails – 40mm length (R)	1	–	4.70

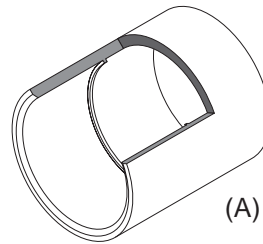

Socket P/P

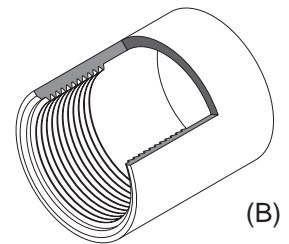

Socket P/FT

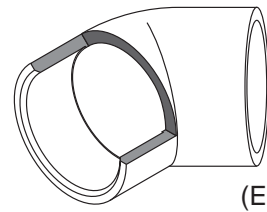

45° Elbow P/P

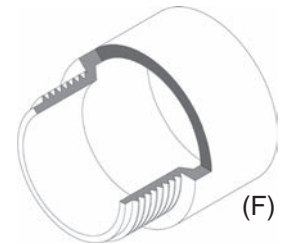

Socket Nipple P/MT

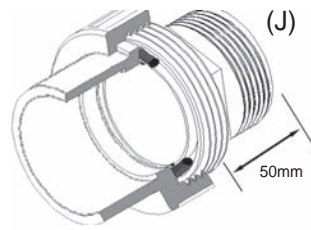

Socket Union P/MT

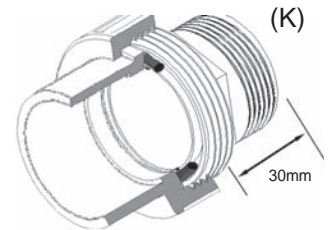

Socket Union P/MT

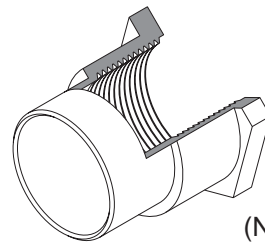

MP/FT Adaptor

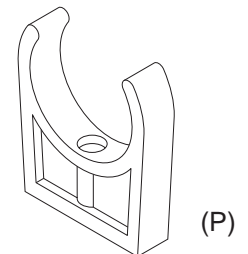

Pipe Clip

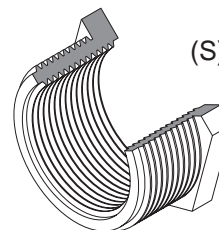

Threaded Reducer

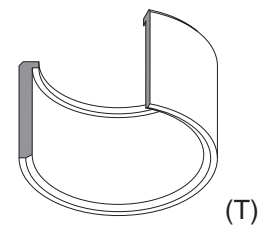

Plain Reducer

2" Pipe & Fittings



Made in the UK

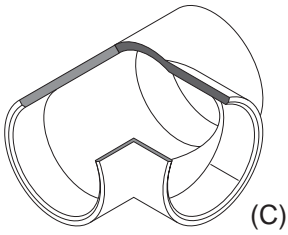

'T' P/P/P

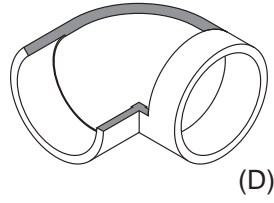

90° Elbow P/P

Class C Pipe

DISCOUNT/ PRODUCT CODE	DESCRIPTION	NO. IN PACK	PRICE EACH
C PPF2015	3m	5	137.30

Sockets

DISCOUNT/ PRODUCT CODE	DESCRIPTION	NO. IN PACK	NO. IN BOX	PRICE EACH
C PPF20510	P/P (A)	10	250	32.50
C PPF205C10	63mm – 2" Socket Reducer P/P	10	250	37.70
C PPF20610	P/FT (B)	10	250	43.20

T Joint & Elbows

DISCOUNT/ PRODUCT CODE	DESCRIPTION	NO. IN PACK	NO. IN BOX	PRICE EACH
C PPF20710	'T' Joint P/P/P (C)	10	90	56.50
C PPF20810	90° Elbow P/P (D)	10	120	46.60
C PPF20910	45° Elbow P/P (E)	10	150	43.60

Nipples

DISCOUNT/ PRODUCT CODE	DESCRIPTION	NO. IN PACK	NO. IN BOX	PRICE EACH
C PPF21010	Socket Nipple P/MT (F)	10	250	32.60
C PPF21110	Nipple P/MT (G)	10	300	31.60

Socket Unions

DISCOUNT/ PRODUCT CODE	DESCRIPTION	NO. IN PACK	NO. IN BOX	PRICE EACH
C PPF2125	Socket Union P/P (H)	5	240	56.00
C PPF2135	Socket Union P/MT (J)	5	200	55.70
C PPF2335	Socket Union P/FT (L)	5	240	52.70
C PPF215	Composite Union P/MT	1	10	42.00
C PPF216	Composite Union P/FT	1	10	39.40

Miscellaneous

DISCOUNT/ PRODUCT CODE	DESCRIPTION	NO. IN PACK	NO. IN BOX	PRICE EACH
C PPF25025	Pipe Clip (P)	25	1000	38.80
E MPF504	Double Union Ball Valve	1	16	37.80

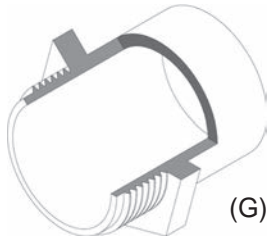

Nipple MP/MT

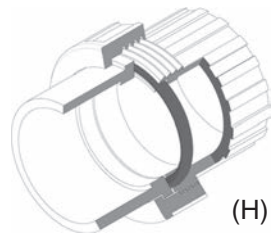

Socket Union P/P

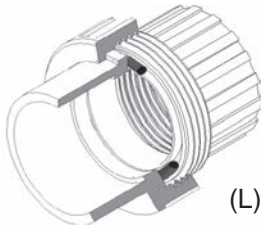

Socket Union P/FT

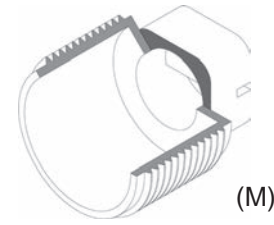

Threaded Plug

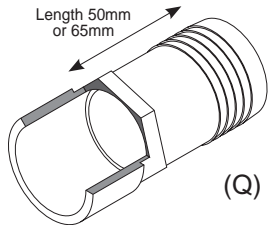

Hosetail Plain

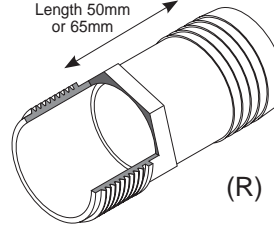

Hosetail Threaded

MOQ = Contact Customer Services for Quote and minimum order requirement

Note: ABS pipe should not be used where ozone is present

ABS Pipe and Pipe Fittings are sold in pack sizes only

Maximum temperature 70°C (158°F)

P = Pipe Socket MP = Male Plain FT = Female Thread MT = Male Thread

PVC Pipe & Fittings

Pipe (3m lengths)

DISCOUNT/ PRODUCT CODE	DESCRIPTION	PRICE EACH
H PVC005	0.5"	5.90
H PVC010	0.75"	8.20
H PVC015	1"	10.40
H PVC020	1.25"	13.20
H PVC025	1.5"	17.10
H PVC030	2"	21.60
H PVC035	3"	44.50

0.5"

DISCOUNT/ PRODUCT CODE	DESCRIPTION	PRICE EACH
H PVC105	90° Elbow P/P (A)	0.80
H PVC110	45° Elbow P/P (B)	1.15
H PVC115	Socket P/P (L)	0.80
H PVC120	Socket Union P/P (C)	4.00
H PVC125	'T' Joint P/P/P (G)	1.25
H PVC130	End Cap (H)	0.80
H PVC135	Barrel Nipple P/T (D)	1.60
H PVC140	Socket Nipple P/T (M)	0.85
H PVC990	Pipe Clip (J)	1.90

0.75"

DISCOUNT/ PRODUCT CODE	DESCRIPTION	PRICE EACH
H PVC205	90° Elbow P/P (A)	1.10
H PVC210	45° Elbow P/P (B)	1.70
H PVC215	Socket P/P (L)	0.90
H PVC220	Socket Union P/P (C)	4.50
H PVC225	'T' Joint P/P/P (G)	1.40
H PVC230	End Cap (H)	0.90
H PVC235	Barrel Nipple P/T (D)	2.00
H PVC240	Socket Nipple P/T (M)	1.50
H PVC991	Pipe Clip (J)	2.00

1"

DISCOUNT/ PRODUCT CODE	DESCRIPTION	PRICE EACH
H PVC305	90° Elbow P/P (A)	1.70
H PVC310	45° Elbow P/P (B)	2.30
H PVC315	Socket P/P (L)	1.00
H PVC320	Socket Union P/P (C)	5.90
H PVC325	'T' Joint P/P/P (G)	2.25
H PVC330	End Cap (H)	1.00
H PVC335	Barrel Nipple P/T (D)	2.50
H PVC340	Socket Nipple P/T (M)	2.00
H PVC992	Pipe Clip (J)	2.20

1.25"

DISCOUNT/ PRODUCT CODE	DESCRIPTION	PRICE EACH
H PVC405	90° Elbow P/P (A)	3.00
H PVC410	45° Elbow P/P (B)	3.10
H PVC415	Socket P/P (L)	1.80
H PVC420	Socket Union P/P (C)	7.30
H PVC425	'T' Joint P/P/P (G)	3.20
H PVC430	End Cap (H)	1.50
H PVC435	Barrel Nipple P/T (D)	3.40
H PVC440	Socket Nipple P/T (M)	2.60
H PVC993	Pipe Clip (J)	3.00

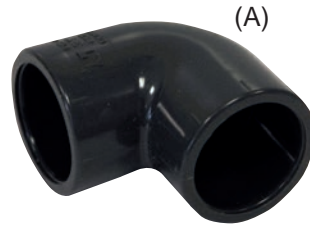

90° Elbow

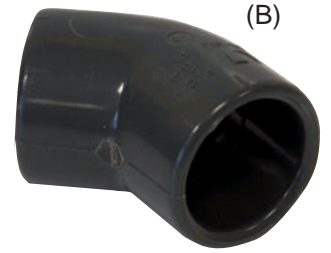

45° Elbow

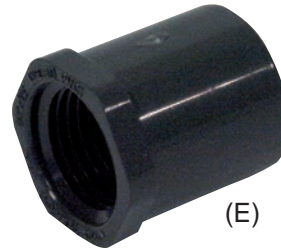

Reducing Bush P/T

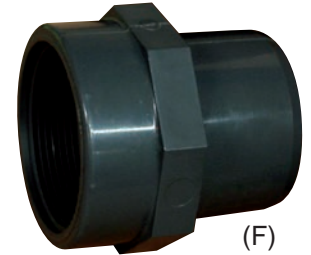

Adaptor MP/FT



Pipe Clip

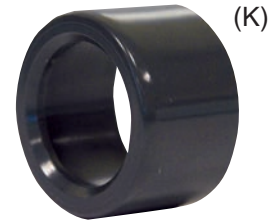

Reducing Bush P/P

1.5"

DISCOUNT/ PRODUCT CODE	DESCRIPTION	PRICE EACH
H PVC505	90° Elbow P/P (A)	3.50
H PVC510	45° Elbow P/P (B)	4.00
H PVC515	Socket P/P (L)	2.10
H PVC520	Socket Union P/P (C)	10.00
H PVC525	'T' Joint P/P/P (G)	4.60
H PVC530	End Cap (H)	2.50
H PVC535	Barrel Nipple P/T (D)	3.70
H PVC540	Socket Nipple P/T (M)	3.20
H PVC994	Pipe Clip (J)	3.22

2"

DISCOUNT/ PRODUCT CODE	DESCRIPTION	PRICE EACH
H PVC605	90° Elbow P/P (A)	5.20
H PVC610	45° Elbow P/P (B)	5.40
H PVC615	Socket P/P (L)	3.00
H PVC620	Socket Union P/P (C)	12.90
H PVC625	'T' Joint P/P/P (G)	6.70
H PVC630	End Cap (H)	3.10
H PVC635	Barrel Nipple P/T (D)	4.80
H PVC640	Socket Nipple P/T (M)	4.20
H PVC995	Pipe Clip (J)	4.10

PVC Pipe & Fittings



Socket Union P/P

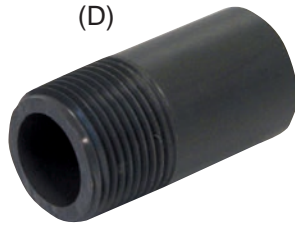

Barrel Nipple P/T

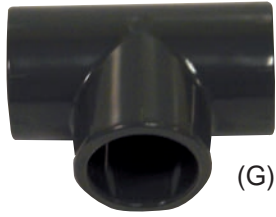

'T' Joint P/P/P

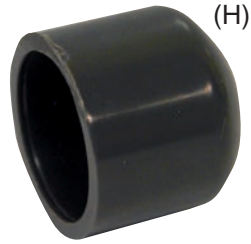

End Cap



Socket



Socket Nipple P/T

3"

DISCOUNT/ PRODUCT CODE	DESCRIPTION	PRICE EACH
H PVC705	90° Elbow P/P (A)	16.50
H PVC710	45° Elbow P/P (B)	15.00
H PVC715	Socket P/P (L)	9.90
H PVC720	Socket Union P/P (C)	46.30
H PVC725	'T' Joint P/P/P (G)	21.20
H PVC730	End Cap (H)	9.50
H PVC735	Barrel Nipple P/T (D)	12.60
H PVC740	Socket Nipple P/T (M)	16.50
H PVC996	Pipe Clip (J)	9.50

Bushes

DISCOUNT/ PRODUCT CODE	DESCRIPTION	PRICE EACH
H PVC905	0.75" to 0.5" P/P (K)	0.80
H PVC910	1" to 0.75" P/P (K)	1.00
H PVC915	1.25" to 1" P/P (K)	1.40
H PVC920	1.5" to 1.25" P/P (K)	1.60
H PVC925	1.5" to 1" P/P (K)	1.60
H PVC930	1.5" to 0.75" P/P (K)	1.60
H PVC935	2" to 1.5" P/P (K)	2.30
H PVC940	3" to 2" P/P (K)	6.40
H PVC955	0.75" Plain to 0.5" Threaded (E)	1.70

Male Plain to Female Thread Adaptors

DISCOUNT/ PRODUCT CODE	DESCRIPTION	PRICE EACH
H PVC960	0.5" (F)	2.40
H PVC965	0.75" (F)	2.80
H PVC970	1" (F)	3.20
H PVC975	1.25" (F)	3.90
H PVC980	1.5" (F)	4.60
H PVC985	2" (F)	8.30
H PVC957	1" Plain to 0.75" Threaded (E)	2.40

Pipe & Fitting Saver

- Reams old pipe material out of fittings for re-use.
- Requires a drill with a 12mm size chuck

Pipe & Fitting Saver

DISCOUNT/ PRODUCT CODE	DESCRIPTION	PRICE EACH
PFS-150	1.5" Fitting Saver	49.00
PFS-200	2" Fitting Saver	52.00



Adhesives

Adhesives

DISCOUNT/ PRODUCT CODE	DESCRIPTION	PACK SIZE	PRICE EACH
B PPF125	ABS & PVC Pipe Cement with Brush (250ml)	20	10.70
B PPF127	Pipe Cleaner (250ml)	20	7.30
B PPF128	Clear Silicone Sealant (310ml)	12	11.00
B PPF130	Pack of 10 PTFE Tape (12mm x 12m)	10	9.00
B PPF132	Wet 'R' Dry Fast Cure Cement with Brush (500ml)	12	20.50
B PPF135	Wet 'R' Dry Fast Cure Cement with Brush (240ml)	24	12.90
B PPF134	Cleaning Fluid (473ml)	12	13.40

Note: Pack sizes shown for information purposes only



Silicon Lubricant

- Added protection and lubrication
- Waterproof and chemical resistant
- Can be used under adverse conditions

Magic Lube II

DISCOUNT/ PRODUCT CODE	DESCRIPTION	PRICE EACH
MAGI001	30g tube	5.20



Teflon Lubricant

- Waterproof and chemical resistant
- Prevents rust and corrosion
- Wide temperature range
- PTFE based

Magic Lube

DISCOUNT/ PRODUCT CODE	DESCRIPTION	PRICE EACH
MAGI002	30g tube	3.30



Winterising Plugs

- Rubber plug with butterfly nut
- 1.25" to 2.5"

Rubber

DISCOUNT/ PRODUCT CODE	DESCRIPTION	PRICE EACH
PWP8000	1.25" to 1.5" d1 34mm to d2 41mm x h25mm	3.00
PWP9000	1.5" to 2" d1 42mm to d2 50mm x h26mm	3.00
PWP10000	2" to 2.5" d1 54mm to d2 63mm x h27mm	3.50

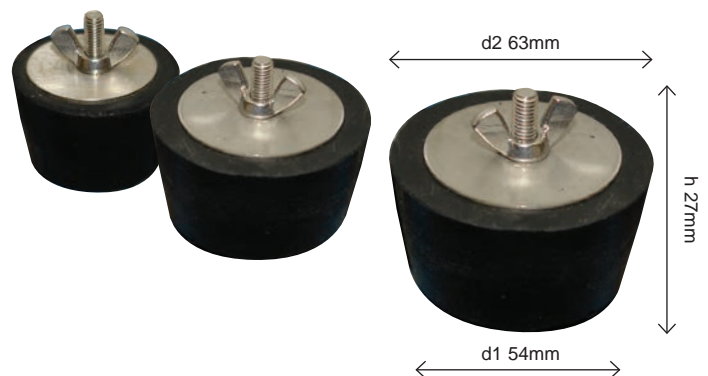

3-Way Valves

- Ideal for diverting flow on solar heating kits

3-Way Valves

DISCOUNT/ PRODUCT CODE	DESCRIPTION	PRICE EACH
E MVA333 1.5"		23.00
E MVA330 2"		42.50

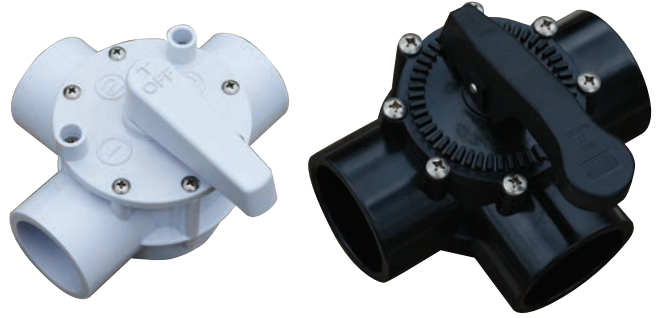

Double Union Ball Valves

Double Union Ball Valves

DISCOUNT/ PRODUCT CODE	DESCRIPTION	PACK SIZE	PRICE EACH
E PPF120 1.5"		24	20.00
E MPF504 2"		16	37.80



Non-Return Valves

Non-Return Valves

DISCOUNT/ PRODUCT CODE	DESCRIPTION	PRICE EACH
K MVA215	1.5" Brass	11.00
K H-RA-172288	1.5"-2" Corrosion Resistant	44.00
K WCV001	1.5" Serviceable Non-Return Valve	43.00
K WCV002	2" Serviceable Non-Return Valve	43.00



FlowVis Flow Valve

- Combination functionality of a flow meter and check valve
- Precision flow meter designed for pools, spas and water features
- Install horizontally, vertically, or upside-down

FlowVis Flow Metre

DISCOUNT/ PRODUCT CODE	DESCRIPTION	PRICE EACH
K 132312	Flow Vis - 2" / 2.5"	295.00



Badu Jet Smart

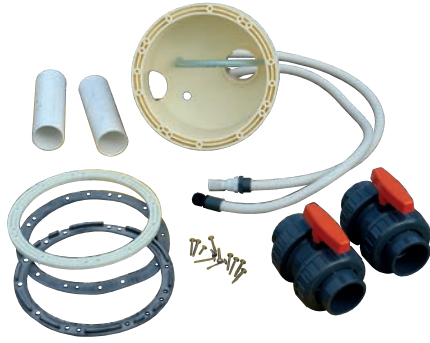

Pre-Assembly Kit

DISCOUNT/ PRODUCT CODE	DESCRIPTION	PRICE EACH
K BAD001	Pre-Assembly Kit	489.00

- For all types of pool (excluding above ground)
- Delivers continuously variable flow rate up to 40m³ per hour
- Massage pressure of 1.8 bar
- Air switch operation

For a complete installation you will need one pre-assembly kit and one Final Assembly Kit

Final Assembly Kit

DISCOUNT/ PRODUCT CODE	DESCRIPTION	PRICE EACH
K BAD002	Pre-Assembly Kit	1943.00



Badu Jet Vogue



Pre-Assembly Kit

DISCOUNT/ PRODUCT CODE	DESCRIPTION	PRICE EACH
K BAD501	Pre-Assembly Kit	355.00

- Manufactured from stainless steel
- Integrated LED light
- Suitable for all pool types
- Air switch operation
- Adjustable nozzle

For a complete installation you will need one pre-assembly kit and one Final Assembly Kit

Final Assembly Kit

DISCOUNT/ PRODUCT CODE	DESCRIPTION	PRICE EACH
K BAD500	Final Assembly Kit Single Phase 2.20kW	3418.00



Espa Counter Current System

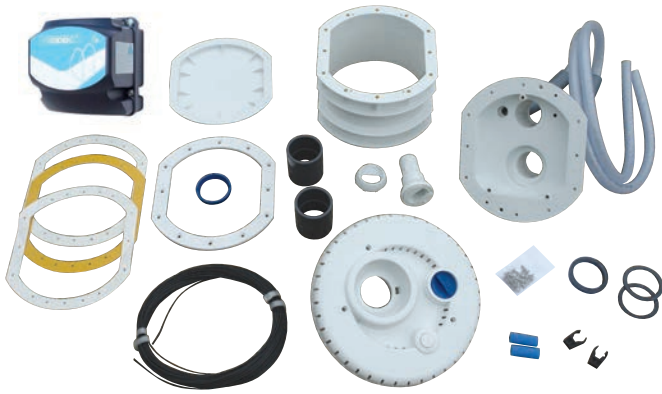

Front Jet Kit

DISCOUNT/ PRODUCT CODE	DESCRIPTION	PRICE EACH
K NCC001K	Single Phase Kit with Control Box	795.00

- Directional outlet nozzle
- Adjustable water flow rate and air/water mix
- Liner and concrete pools
- Operated by air switch from inside the pool
- Use 75mm when over 3m

Nadorself Pump

DISCOUNT/ PRODUCT CODE	DESCRIPTION	PRICE EACH
K NCP300	Single Phase 3hp	925.00

- Powerful performance
- Flow rates challenge all swimmers
- Single phase pump: 3hp (2.3kW) provides 60m³/h
- Self priming up to 4m
- Can be installed up to 3m from pool

For a complete installation you will need one pump and one front jet kit

63mm Metric PVC Pipe & Fittings

DISCOUNT/ PRODUCT CODE	DESCRIPTION	PRICE EACH
H PPF660	Pipe per 5m Length	40.00
H PPF656	90° Elbow P/P	4.40
H PPF657	45° Elbow P/P	5.40
H PPF658	Socket Union P/P	10.60
H PPF659	Socket P/P	2.40
H PPF622	Double Union Ballvalve	45.40

75mm Metric PVC Pipe & Fittings

DISCOUNT/ PRODUCT CODE	DESCRIPTION	PRICE EACH
H PPF654	Pipe per 5m length	56.50
H PPF650	90° Elbow P/P	9.60
H PPF651	45° Elbow P/P	8.80
H PPF652	Socket Union P/P	32.70
H PPF653	Socket P/P	5.50
H PPF655	Double Union Ballvalve	135.60
H PPF620	Socket P/FT	16.20

Plumbing Kit

DISCOUNT/ PRODUCT CODE	DESCRIPTION	PRICE EACH
K PPK005K	Kit	194.00

Flexible Pipe Plumbing Kit contains:

- 2 x 75mm Female Threaded Plain Socket
- 2 x 75mm to 63mm Reducing Bushes
- 2 x 63mm Double Union Ballvalve
- 2 x 3m 63mm Flexfit Pipe
- 1 x 500ml Wet 'R' Dry Fast Cure Cement with Brush

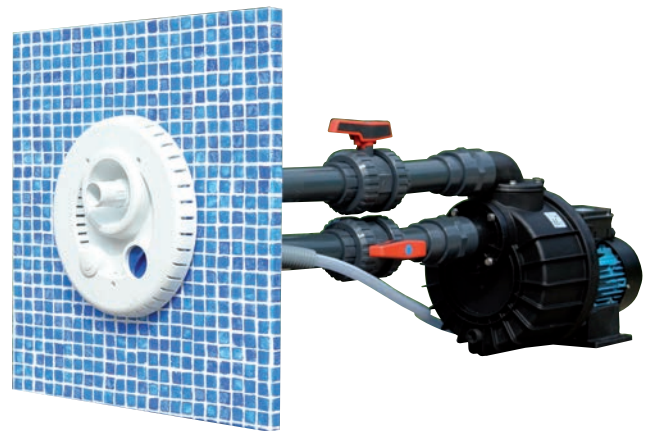

X-Stream Counter Current Unit

NEW FOR
2017



- 316 Stainless Steel
- One pneumatic air switch
- Single or two pump operation
- Two water/air jets
- handrail as standard
- 2 1/2" BSP/F treaded suction

X-Stream Counter Current Unit

DISCOUNT/ PRODUCT CODE	DESCRIPTION	PRICE EACH
K XST001	X-Stream with SS grabrail	2040.00
K XST002	X-Stream with SS grabrail with dual pump	2140.00

X-Stream Plumbing Kit (75mm)

DISCOUNT/ PRODUCT CODE	DESCRIPTION	PRICE EACH
K XST001PK	X-Stream Plumbing Kit for XST001	407.00
K XST002PK	X-Stream Plumbing Kit for XST002	657.00

XST001PK X-Stream Plumbing Kit 75mm contains:

- PPF655 Double union ballvalves x 2
- PPF620 Sockets P/FT x 2
- PPF623 Sockets nipples P/MT x 1
- PPF132 Wet R Dry 500ml x 1
- PPF654 75mm pipe 5m
- PPF130S PTFE x 3
- PPF650 90° elbow x 1

Single Pump X-Stream Kit

DISCOUNT/ PRODUCT CODE	DESCRIPTION	PRICE EACH
K XST001K	X-Stream Kit for XST001	3482.00

Single Pump X-Stream Kit contains:

- XST001
- PINCC17
- XST001PK X-Stream Plumbing Kit
- NCP300 Nadorself
- 60m³/h

Dual Pump X-Stream Kit (Duo)

DISCOUNT/ PRODUCT CODE	DESCRIPTION	PRICE EACH
K XST002K	X-Stream Kit for XST002	4080.00

Dual Pump X-Stream Kit contains:

- XST002
- PINCCDUO
- XST002 pk X-Stream plumbing kit
- WIP300 x 2
- 100m³/h

Counter Current Controllers

- Operate with air switch button (not supplied)
- PINCC17 - Controls 1 x 3hp pump (13.4amp)
- PINCCDUO - Controls 2 x 3hp pumps (11amp) with one press of air switch, time delay between pumps to reduce start-up current.
- Compact enclosure

Counter Current Controllers

DISCOUNT/ PRODUCT CODE	DESCRIPTION	PRICE EACH
K PINCC17	Counter Current Controller (single pump 13.4a)	110.00
K PINCCDUO	Counter Current Controller (dual pump 11a)	235.00



ESPA Pumps

- Jet-stream swimming in public or private swimming-pools
- Shaft in stainless steel AISI 431
- 10.000 hours P2 capacitor with aluminium casing
- 75mm threaded connections
- Mechanical seal in graphite
- Single phase with built-in thermal protection

ESPA Nadorsel

DISCOUNT/ PRODUCT CODE	DESCRIPTION	PRICE EACH
K NCP300	Nadorsel 300	925.00

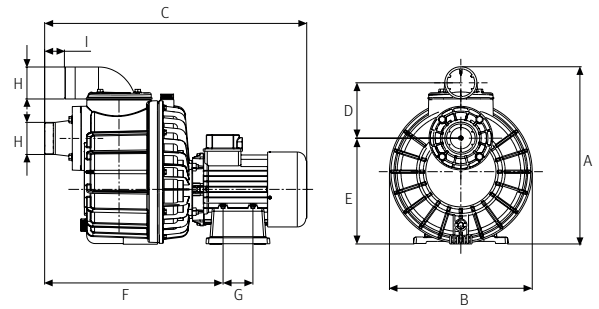
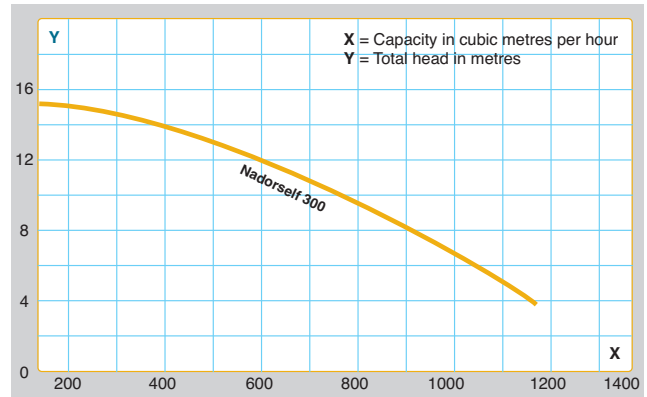

Model	A	B	C	D	E	F	G	H	I	Kg
Nadorsel 300	416	335	615	130	248,5	418,5	70	21½	46,5	26,1/25,8

- Water recirculation in spas and private pools.
- Suction cover and discharge body in tecnopolymer.
- Impeller and pump foot in tecnopolymer.
- Mechanical seal in graphite and steatite.
- 63mm suction and discharge.
- Shaft in stainless steel AISI 431.
- Motor housing in aluminium.
- O'rings in NBR.

ESPA Wiper 3

DISCOUNT/ PRODUCT CODE	DESCRIPTION	PRICE EACH
K WIP300	Wiper3 300 Single Phase 3HP	524.00

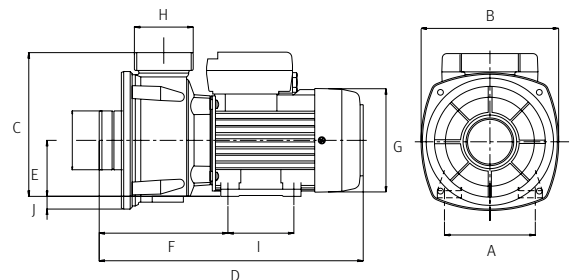
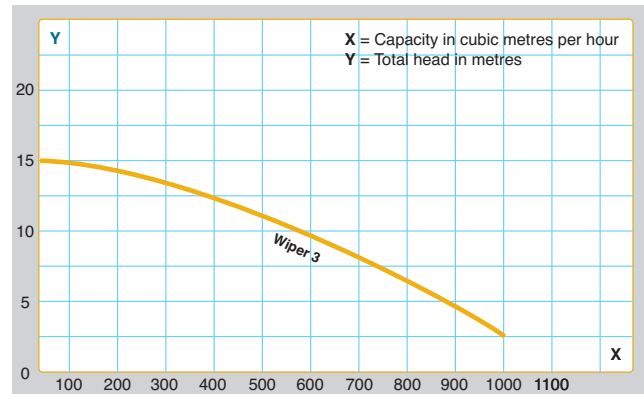

Model	A	B	C	D	E	F	G	H	I	Kg
Wiper 300	130	298,7	230	160	120	108	63	162	124	18,8

AquaJet Counter Current Unit

- | | |
|--|--|
| <p>AquaJet 50</p> <ul style="list-style-type: none"> • 230v • 48m³ per hour max • 1.1kW • Pneumatic control • Switch on/off in pool • LED lights in jet surround • Weighs 20kg | <p>AquaJet 100</p> <ul style="list-style-type: none"> • 230v • 100m³ per hour max • 1.1kW • Water flow intensity control • Adjustable Venturi • Colour changing LED lights • Weighs 35kg |
|--|--|



Aquajet

DISCOUNT/ PRODUCT CODE	DESCRIPTION	PRICE EACH
K 3BTE0354	AquaJet 50	1240.00
K AQ100	AquaJet 100	2200.00

Badu Jet

- Two versions available to best suit swimming ability
- Omnidirectional swivel nozzle 60 deg range
- Support leg for above ground pool installations

Badu Jet

DISCOUNT/ PRODUCT CODE	DESCRIPTION	PRICE EACH
K BAD015	Perla Single Phase 1.6kW	2401.00
K BAD006	Riva Single Phase 2.2kW	3017.00
K BAD004	Telescopic Support Leg (777 to 1390mm)	186.00



Badu Jet	Voltage	Power Input	Power Output	m ³ /h	Pressure at Nozzle	Supply Required
Perla	230v	2300W	1.6kW	40	0.9 bar	16a C rated fuse
Riva	230v	2900W	2.2kW	54	1.0 bar	20a C rated fuse

Badu Jet Accessories

Badu Jet Accessories

DISCOUNT/ PRODUCT CODE	DESCRIPTION	PRICE EACH
K BAD005	Massage Hose with 40mm nozzle	105.00
K BAD007	Pulsator Nozzle	201.00
K BAD008	Pinpoint Massage Nozzle	32.00
K BAD011	Pump Console (Mounting Frame)	341.00

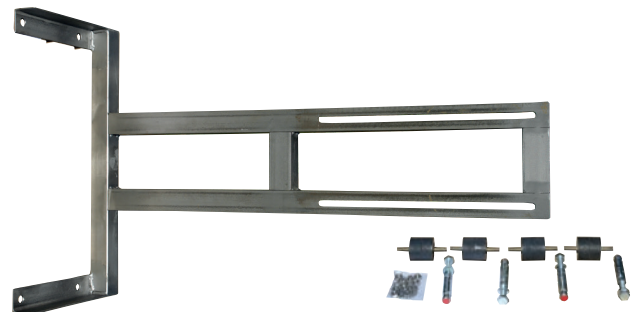

Badu Jet Pump Console – BAD011

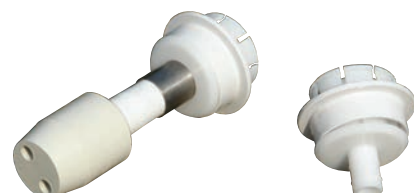

Badu Jet Accessories– BAD007 & BAD008