

# Covers & Reels

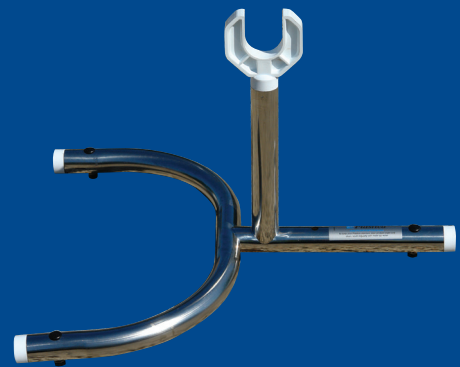

Covers  
& Reels

**bespoke**  
**POOL SALES**



Bespoke Sales LTD.  
sales@bespokepoolsales.co.uk  
(UK) Tel: 1 001268 710425

# Solar Covers



Made in the UK

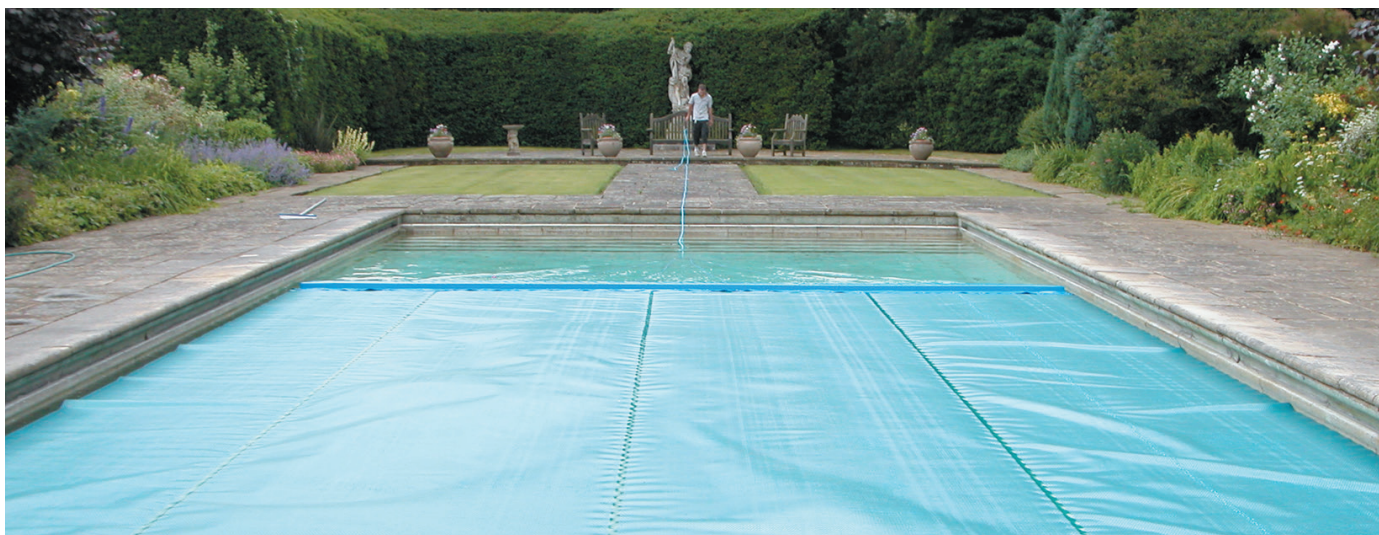

Points common to all Solar Covers:

- Covers are invoiced to the nearest sq.m.
- When calculating cover prices round up to the nearest square metre
- Covers come complete with a Solar Protector Sheet to be used when the cover is off the pool
- Covers are made oversized
- Non-hemmed covers are rectangular to be trimmed on site
- Covers over 12m should be fitted with reinforcing and a leading edge
- All covers fitted with a Commercial Leading Edge will be rolled and could therefore incur a Commercial Carriage Charge. All other Solar Covers are bagged.
- Hemmed covers must be ordered using the form provided in the Plastica Forms booklet

To convert from sq.ft to sq.m. multiply the sq.ft. size by 0.0929

## Finishing Options

DISCOUNT/ PRODUCT CODE	DESCRIPTION	PRICE EACH
R HEM400S	Hemming for Solar Covers per m. run	3.70
R SHPM400S	Shaping Surcharge per m <sup>2</sup>	3.60
R CUT400S	Cut-out Charge for Floating Covers	47.00
R SHPA400S	Charge for Shaping Bay	39.00
K FITSTRAPS	Attach Strap Set to Cover	12.80
K WEB025	25m Roll of Blue Webbing (25mm)	25.40
K EYELETS	Reinforced Eyelet	5.30

Note: Welding on solar covers can lead to a slight waving

Cover guarantee is void if pool temperature exceeds 29°C, or SPATA standards for chemical and TDS levels are not met

**Hemming (if ordered) will be supplied in black unless otherwise requested on EnergyGuard or Black 400 covers**

## Premium Domestic Leading Edge



Made in the UK

- Strong and durable PVC coated polyester netting
- Polyethylene foam inserts for added buoyancy
- Easily installed on new or existing covers by end user
- Complete with fixings and pull cord
- Now also available in black

### Premium Domestic Leading Edge

DISCOUNT/ PRODUCT CODE	DESCRIPTION	PRICE EACH
J CLE012	12' (3.65m model) *	102.50
J CLE016	16' (4.8m model) **	127.00
J CLE020	20' (6.10m model) ***	153.00
J DLE12S	Attach 12' *	152.00
J DLE16S	Attach 16' **	182.00
J DLE20S	Attach 20' ***	210.00
J CLE012BK	12ft Domestic Cover Leading Edge Black	102.50
J CLE016BK	16ft Domestic Cover Leading Edge Black	127.00
J CLE020BK	20ft Domestic Cover Leading Edge Black	210.00
J DLE12SBK	Attach 12ft Black Leading Edge	152.50
J DLE16SBK	Attach 16ft Black Leading Edge	182.00
J DLE20SBK	Attach 20ft Black Leading Edge	210.00

\* for pool sizes 2.74m to 3.96m wide (9.14m tow cord)

\*\* for pool sizes 3.97m to 5.18m wide (12.19m tow cord)

\*\*\* for pool sizes 5.19m to 6.4m wide (15.24m tow cord)





# new EnergyGuard™ Selective Transmission

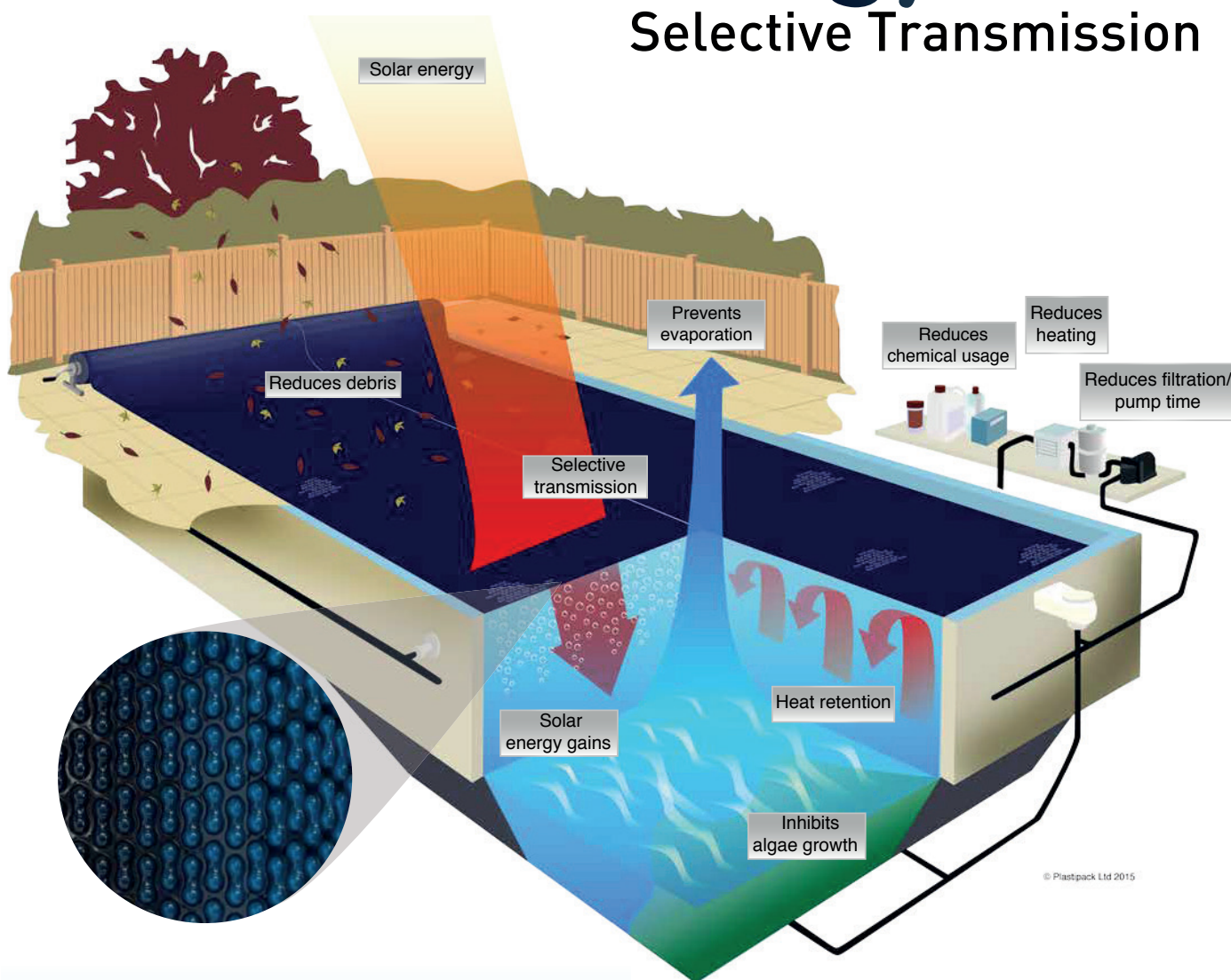

Covers & Reels

### **EnergyGuard™ specific benefits:**

- Increases water temperature by up to 7°C
- Algae growth is inhibited
- Reduces filtration times by up to 50%
- Reduces chemical consumption by up to 60%
- Reduces energy consumption by up to 60%
- Can be used as a winter cover

### **General cover benefits:**

- Available with GeoBubble™ technology
- Eliminates water evaporation by 98% +
- Reduces debris contamination
- Saves money and shrinks your carbon footprint
- 6 year pro rata manufacturer's warranty



Contact us now for a  
Cover Sample Pack on  
**1001268 710425**



Covers  
& Reels

- Clear top, tinted translucent underside
- 500 micron
- Increase pool temperature by up to 8°C
- Eliminate water evaporation by 98% +
- Cut chemical consumption by up to 30%
- Lower energy consumption by over 50%
- 6 year pro-rata warranty (UK & Eire only)



- Sol+Guard 180 has higher UV stabilisation which is designed for use in hotter climates.

Sol+Guard is a registered trademark of Plastipack Limited

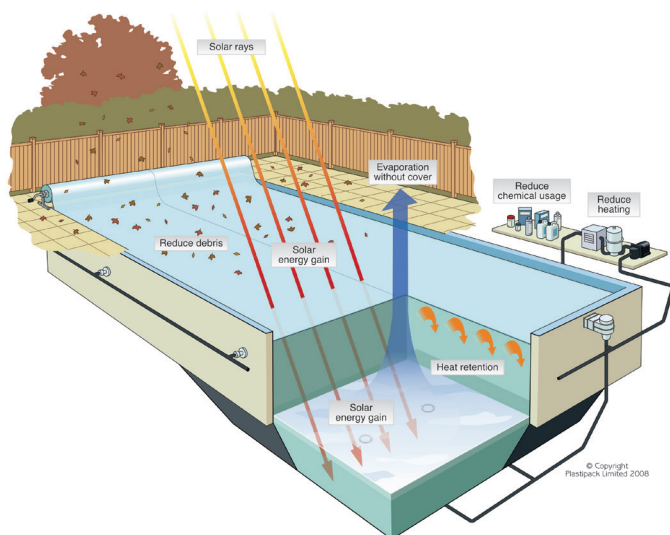

## Sol+Guard 140

DISCOUNT/ PRODUCT CODE	DESCRIPTION	PRICE EACH
R3 PGS500 per sq.m.		10.60
R3 PGS510 10' x 20' (19m²)		201.40
R3 PGS512 12' x 24' (27m²)		286.20
R3 PGS514 14' x 28' (36m²)		381.60
R3 PGS515 15' x 30' (42m²)		445.20
R3 PGS516 16' x 32' (48m²)		508.80
R3 PGS520 20' x 40' (74m²)		784.40
R3 PGS550 5' x 10' Bay (5m²)		53.00

## Sol+Guard™ 180

DISCOUNT/ PRODUCT CODE	DESCRIPTION	PRICE EACH
R3 PGS580 per sq.m.		11.15

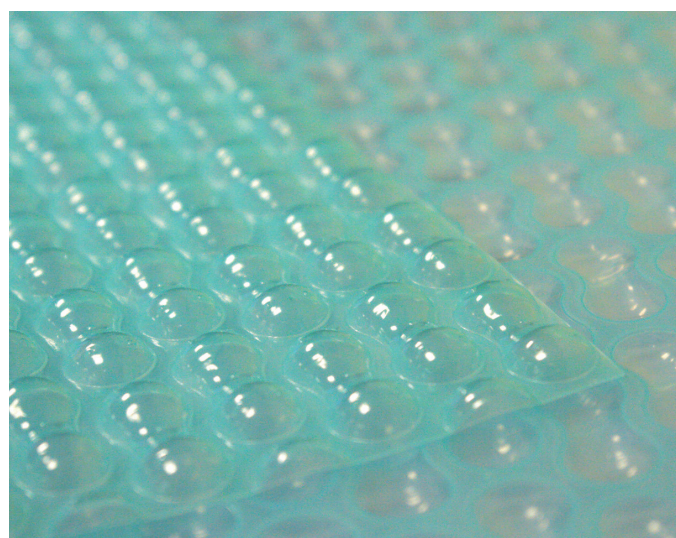



- Gold underside gives an aqua blue top colour
- 500 micron
- 0.48Kg per sq.m
- Blue top with gold underside
- 4 year pro-rata warranty (UK & Eire only)

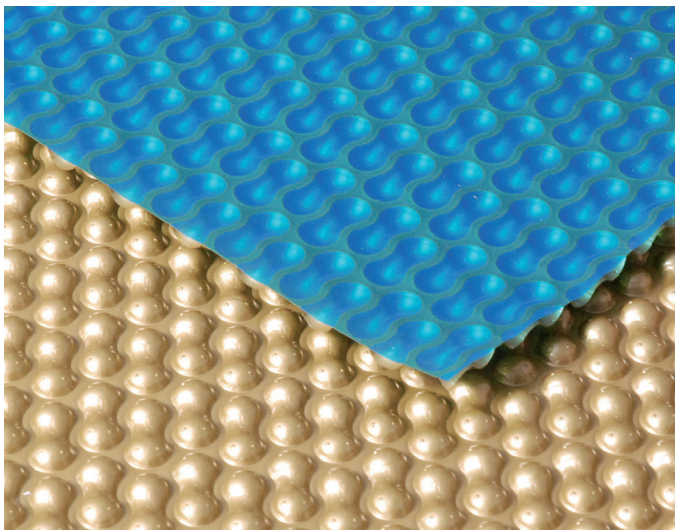

## Midas 500

DISCOUNT/ PRODUCT CODE	DESCRIPTION	PRICE EACH
R PGM500	per sq.m.	9.70
R PGM510	10' x 20' (19m <sup>2</sup> )	184.30
R PGM512	12' x 24' (27m <sup>2</sup> )	261.90
R PGM514	14' x 28' (36m <sup>2</sup> )	349.20
R PGM515	15' x 30' (42m <sup>2</sup> )	407.40
R PGM516	16' x 32' (48m <sup>2</sup> )	465.60
R PGM520	20' x 40' (74m <sup>2</sup> ) (6m x 12m)	717.80
R PGM550	5' x 10' (5m <sup>2</sup> )	48.50



Covers & Reels

## Apollo 400

DISCOUNT/ PRODUCT CODE	DESCRIPTION	PRICE EACH
R PGA400	per sq.m.	7.75
R PGA410	10' x 20' (19m <sup>2</sup> )	147.25
R PGA412	12' x 24' (27m <sup>2</sup> )	209.25
R PGA414	14' x 28' (36m <sup>2</sup> )	279.00
R PGA415	15' x 30' (42m <sup>2</sup> )	325.00
R PGA416	16' x 32' (48m <sup>2</sup> )	372.00
R PGA420	20' x 40' (74m <sup>2</sup> ) (6m x 12m)	573.50
R PGA450	5' x 10' Bay (5m <sup>2</sup> )	38.75

- Silver underside gives extra heat retention
- 400 micron
- 0.37kg per sq.m
- Blue top with silver underside
- 4 year pro-rata warranty (UK & Eire only)

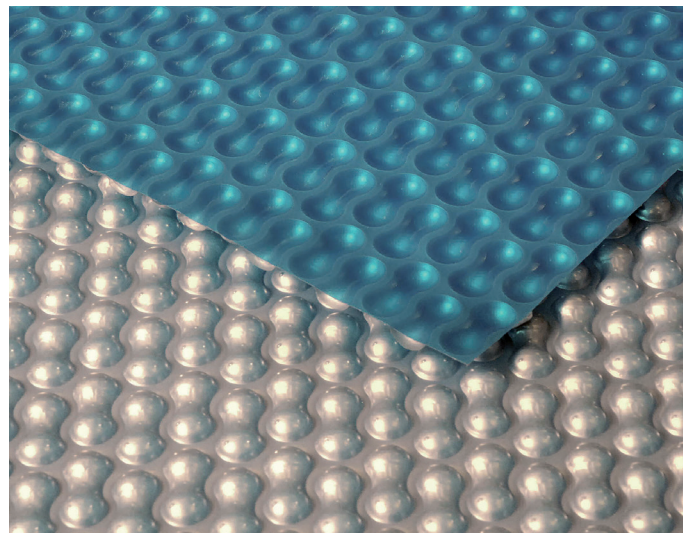

# Translucent Blue 400



Made in the UK

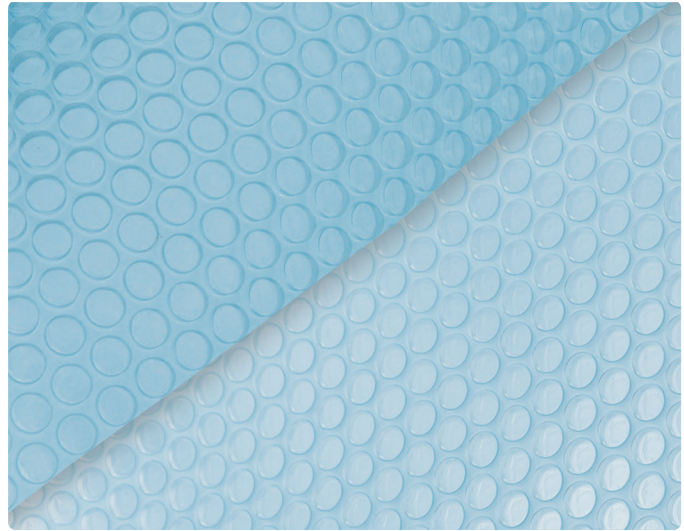

## Translucent Blue 400

DISCOUNT/ PRODUCT CODE	DESCRIPTION	PRICE EACH
R PST400	per sq.m.	6.50

- UV stabilised
- 400 micron
- 0.37kg per sq.m
- Semi-translucent for optimum solar gain
- 3 year pro-rata warranty (UK & Eire only)



# Blue 400



Made in the UK

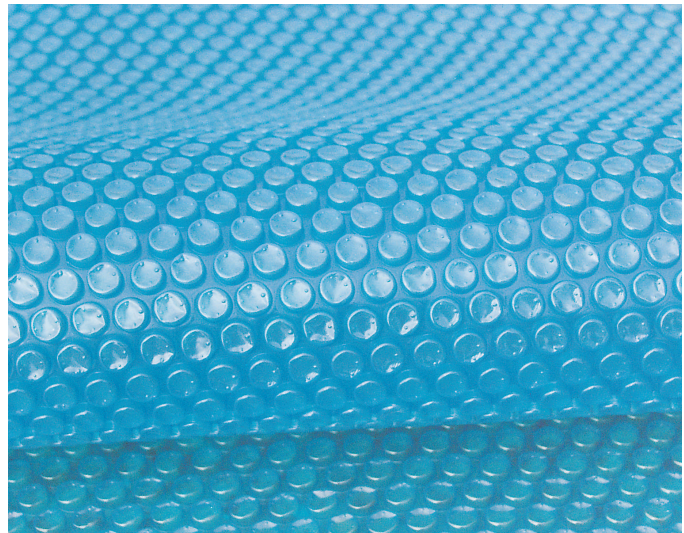

## Blue 400

DISCOUNT/ PRODUCT CODE	DESCRIPTION	PRICE EACH
R PSC400	per sq.m.	6.50
R PSC410	10' x 20' (19m <sup>2</sup> )	123.50
R PSC412	12' x 24' (27m <sup>2</sup> )	175.50
R PSC414	14' x 28' (36m <sup>2</sup> )	234.00
R PSC415	15' x 30' (42m <sup>2</sup> )	273.00
R PSC416	16' x 32' (48m <sup>2</sup> )	312.00
R PSC420	20' x 40' (74m <sup>2</sup> )	481.00
R PSC450	5' x 10' Bay (5m <sup>2</sup> )	32.50

- UV stabilised
- 400 micron
- 0.37kg per sq.m
- Blue top and underside
- 3 year pro-rata warranty (UK & Eire only)



## Above Ground Pool Solar Covers



Made in the UK

- Budget solar cover for above ground pools
- Reduce heating costs and chemical usage
- 200 micron
- 0.22kg per sq.m
- 1 year pro-rata warranty (UK & Eire only)

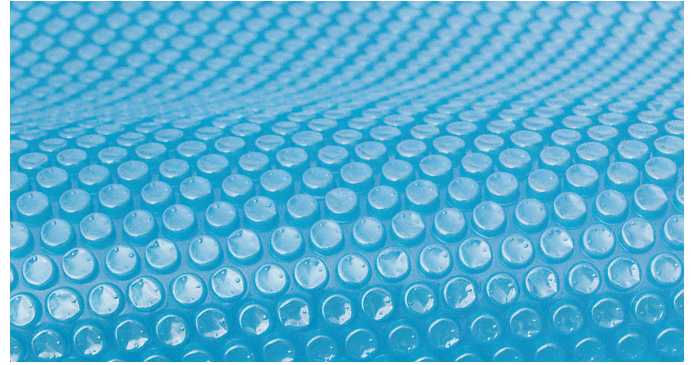

Note: These covers require trimming on site

### Oval

DISCOUNT/ PRODUCT CODE	DESCRIPTION	PRICE EACH
L ASC112	10' x 15'	47.90
L ASC113	10' x 16'	48.40
L ASC114	12' x 18'	62.70
L ASC117	12' x 20'	67.50
L ASC122	12' x 22'	72.70
L ASC124	12' x 24'	78.05
L ASC126	12' x 28'	89.25
L ASC132	16' x 28'	111.25
L ASC118	15' x 30'	112.45
L ASC134	16' x 32'	124.10
L ASC136	18' x 33'	143.15

### Diameter

DISCOUNT/ PRODUCT CODE	DESCRIPTION	PRICE EACH
L ASC008	8'	24.80
L ASC010	10'	32.10
L ASC012	12'	37.50
L ASC015	15'	61.65
L ASC016	16'	69.90
L ASC018	18'	84.80
L ASC024	24'	148.45

## Premium Wooden Pool Solar Covers



Made in the UK

- Budget solar cover for wooden pools
- Reduce heating costs and chemical usage
- 200 micron
- 0.22g per sq.m
- 1 year pro-rata warranty (UK & Eire only)



Note: These covers require trimming on site

### Premium Wooden Pool

DISCOUNT/ PRODUCT CODE	DESCRIPTION	PRICE EACH
L WPC100	Cover for 4m Knightsbridge	45.60
L WPC200	Cover for 5m Mayfair	65.65
L WPC300	Cover for 6m Kensington	86.00
L WPC400	Cover for 5.5m x 3.6m Belgravia	64.50
L WPC500	Cover for 6.5m x 3.6m Bayswater	70.50
L WPC600	Cover for 8.1m x 4.6m Westminster	99.50
L WPC700	Cover for 4.2m x 3.9m Exercise Pool	32.00

## Cover Repair

### Cover Repair

DISCOUNT/ PRODUCT CODE	DESCRIPTION	SUITABLE FOR	PRICE EACH
PLR150	Cover Repair Tape 50mm x 33m roll	All covers	8.40
PLR255	Repair Material 0.15m (6") wide per m	Supercovers	1.65
PLR230	Cover Repair Kit (4 patches per kit)	All covers	3.50





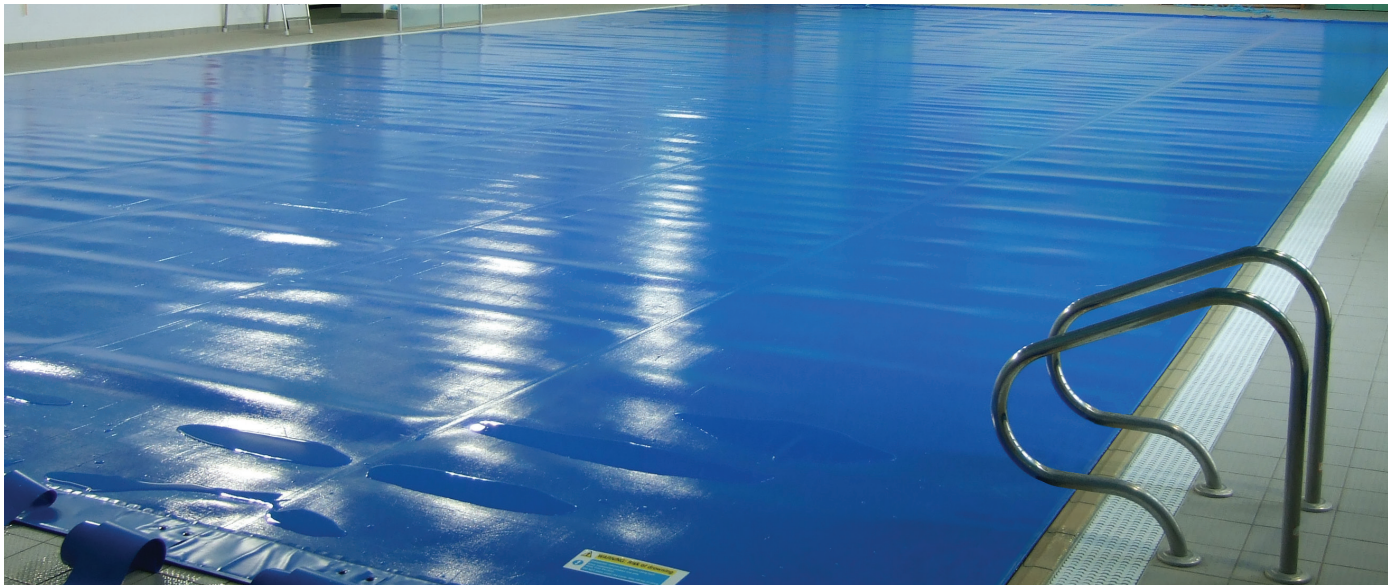



Over 90% of a pool's heat is lost via the water surface; this can be considerably reduced by using a heat retention cover

- Reduce humidity levels
- Reduce the need for heating and ventilation
- Installs on most pool types including free-form pools
- Covers should recoup their costs from energy saving within twelve months
- Covers over 12m should have reinforcing and a leading edge
- Covers are despatched in roll form
- Packaging adds approximately 150mm to cover width
- Perfect lay flat of this material cannot be guaranteed
- We work to +0.2% and -0.5% accuracy of any dimension

## Heat Retention Cover Pricing Formula

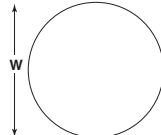
Follow the calculation method to find the Chargeable Area (CA) to the nearest M<sup>2</sup>.

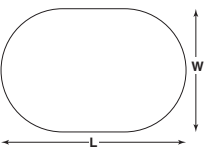
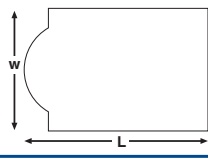
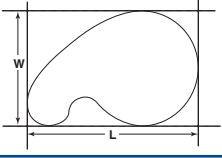
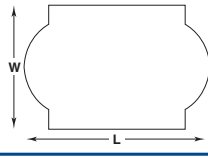
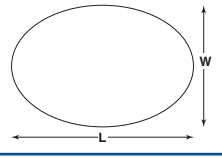
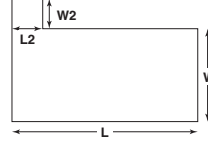
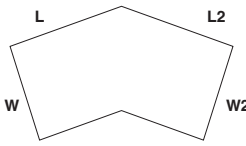
RECTANGULAR	CALCULATION	SHAPED	CALCULATION CIRCULAR
STANDARD SIZE COVER with STEP CUT-OUT	<p><b>Cover Price =</b>                      Cover Area (CA) x Price per m<sup>2</sup>                      PLUS                      1 x Cut-Out Charge <b>CUTCOM</b> per ladder</p>		<p><b>CA = W x W</b>                      Cover Price = CA x (Price per m<sup>2</sup> + Shaping Surcharge per m<sup>2</sup>)</p>
	<p><b>RECTANGULAR</b></p> <p><b>CA = L x W</b>                      Cover Price = CA x Price per m<sup>2</sup></p>		<p><b>OVAL</b></p> <p><b>CA = L x W</b>                      Cover Price = CA x (Price per m<sup>2</sup> + Shaping Surcharge per m<sup>2</sup>)</p>
	<p><b>ROMAN END</b></p> <p><b>CA = L x W</b>                      List Price = CA x Price per m<sup>2</sup>                      Add 1 x Charge for Bay Shaping</p>		<p><b>FREEFORM/KIDNEY</b></p> <p><b>CA = L x W</b>                      Cover Price = CA x (Price per m<sup>2</sup> + Shaping Surcharge per m<sup>2</sup>)</p>
	<p><b>DOUBLE ROMAN END</b></p> <p><b>CA = L x W</b>                      List Price = CA x Price per m<sup>2</sup>                      Add 2 x Standing Charge for Bay Shaping</p>		<p><b>SHAPED OVAL/PEAR</b></p> <p><b>CA = L x W</b>                      Cover Price = CA x (Price per m<sup>2</sup> + Shaping Surcharge per m<sup>2</sup>)</p>
	<p><b>WALK IN STAIRS/BAYS</b></p> <p><b>CA = L x W + (L2 x W2)</b>                      List Price = CA x Price per m<sup>2</sup>                      Add 1 x Charge for Bay Shaping</p>		<p><b>DOG LEG/LAZY 'L'</b></p> <p><b>CA = L x W + (L2 x W2)</b>                      Cover Price = CA x (Price per m<sup>2</sup> + Shaping Surcharge per m<sup>2</sup>)</p>

## EnergyGuard™ Selective Transmission



Made in the UK

- Grey top, black underside
- 500 micron
- Can be used as a winter cover
- Eliminate water evaporation by 98%+
- Reduce chemical usage by up to 60%
- Lower energy consumption by over 50%
- Reduce debris contamination
- 6 year pro-rata warranty (UK & Eire only)



### EnergyGuard™ 140

DISCOUNT/ PRODUCT CODE	DESCRIPTION	PRICE EACH
R3 PGE500	per sq.m.	10.60

- EnergyGuard 180 has higher UV stabilisation which is designed for use in hotter climates.

### EnergyGuard™ 180

DISCOUNT/ PRODUCT CODE	DESCRIPTION	PRICE EACH
R3 PGE580	per sq.m.	11.10

EnergyGuard is a registered trademark of Plastipack Limited

See page 119 for further details

## CoolGuard 500™



Made in the UK

- Light blue top, black underside
- 500 micron
- Can be used as a winter cover
- Eliminate water evaporation by 98%+
- Reduce chemical usage by up to 60%
- Lower energy consumption by over 50%
- Reflects the sun's heat away from the pool
- Designed for areas up to 180KLys/yrs
- Ideal for keeping pools cool in very hot climates
- Reduce debris contamination
- 6 year pro-rata warranty (UK & Eire only)



### CoolGuard™

DISCOUNT/ PRODUCT CODE	DESCRIPTION	PRICE EACH
R3 PGC500	per sq.m.	11.10

CoolGuard is a registered trademark of Plastipack Limited

## Black 400 Bubble Cover



Made in the UK

- UV stabilised
- 0.37kg per sq.m
- Black top and underside increases heat conduction
- 100% opaque material helps control the growth of algae
- 3 year pro-rata warranty (UK & Eire only)

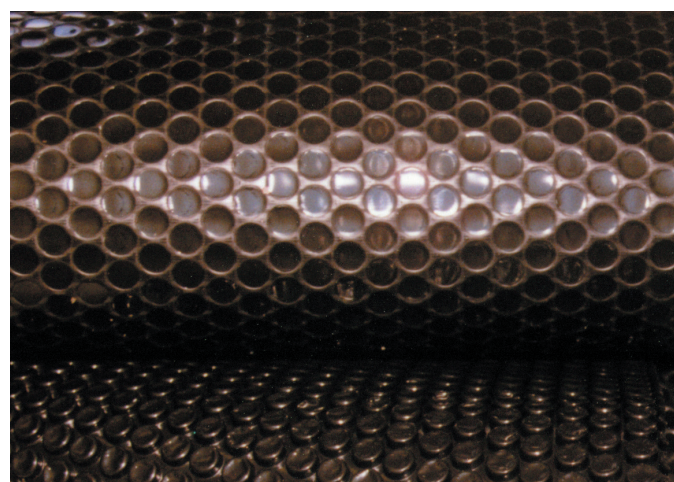

### CoolGuard™

DISCOUNT/ PRODUCT CODE	DESCRIPTION	PRICE EACH
R PSC400B	per sq.m.	7.45

Note: Black hemming is now supplied as standard on black covers

## Supercover (5mm)

INSTALL

MADE TO ORDER

HEAVY ITEM



Made in the UK

- 5mm polyolefine closed cell foam cover
- Tough woven top and bottom sheet for heat retention and strength
- Shaped and hemmed to your specification
- Weighs 0.42kg per m.sq.
- 29°C maximum temperature
- 3 year pro rata guarantee

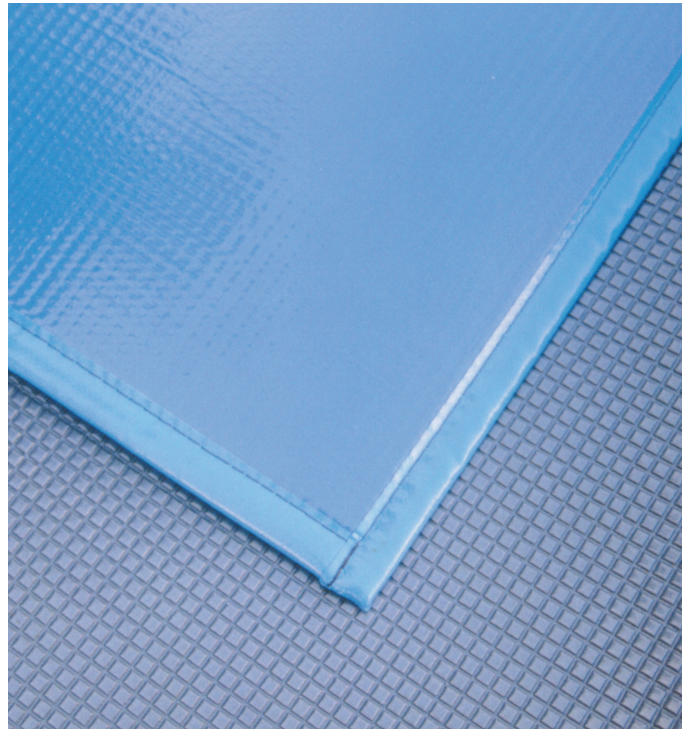

Help should be on hand to off-load larger covers upon delivery

▲ Extra carriage applies to Supercovers

### Supercover (5mm)

DISCOUNT/ PRODUCT CODE	DESCRIPTION	PRICE EACH
J PSU100	per sq. m.	25.00
J SHPMCOMS	Shaping Surcharge per m <sup>2</sup>	3.60
J CUTCOMS	Cut-Out Charge	47.00
J SHPACOMS	Charge for Shaping Bay	39.00

## Premium (8mm)

INSTALL

MADE TO ORDER

HEAVY ITEM



Made in the UK

- 8mm foam centre with embossed underside
- Polyolefine woven fabric top laminate with UV stabilised coating
- Shaped and hemmed to your specification
- Suitable for hydrotherapy pools
- Weighs 0.53kg per sq.m.
- 29°C maximum temperature (39°C max for hydrotherapy pools)
- 4 year pro rata guarantee (one year on hydrotherapy pools)

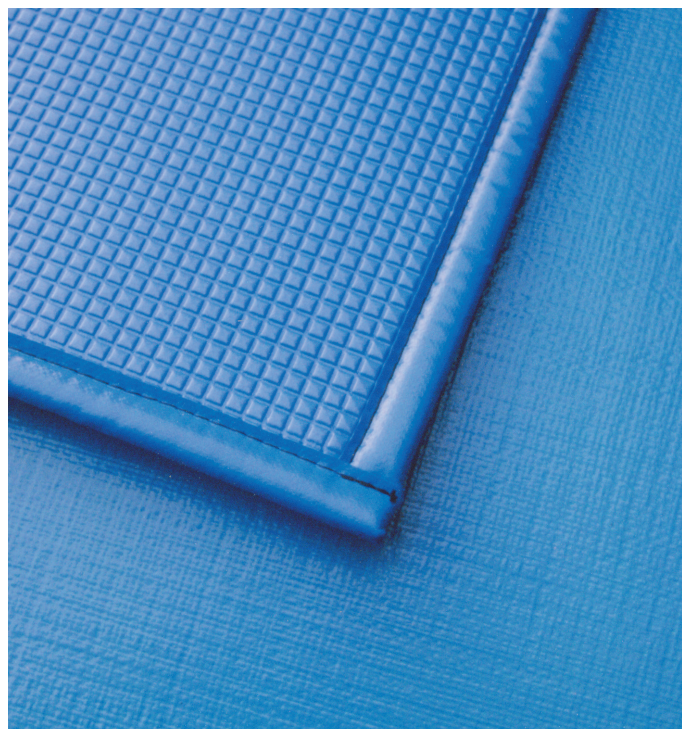

Help should be on hand to off-load larger covers upon delivery.

▲ Extra carriage may be applicable to Premium Covers  
Please see haulage map or call customer services

### Premium (8mm)

DISCOUNT/ PRODUCT CODE	DESCRIPTION	PRICE EACH
J PPR100	per sq. m.	35.60
J SHPMCOMS	Shaping Surcharge per m <sup>2</sup>	3.60
J CUTCOMS	Cut-Out Charge	47.00
J SHPACOMS	Charge for Shaping Bay	39.00

## Spa Cover (12mm)

MADE  
TO  
ORDER

HEAVY  
ITEM



Made in the UK

- For spas and hydrotherapy pools
- 12mm foam centre
- Laminated top and bottom with embossed clear protective layer
- Weighs 0.49kg per sq.m.
- 39°C maximum running temperature.
- Guarantee limited to 1 year due to higher water temperatures and chemicals.

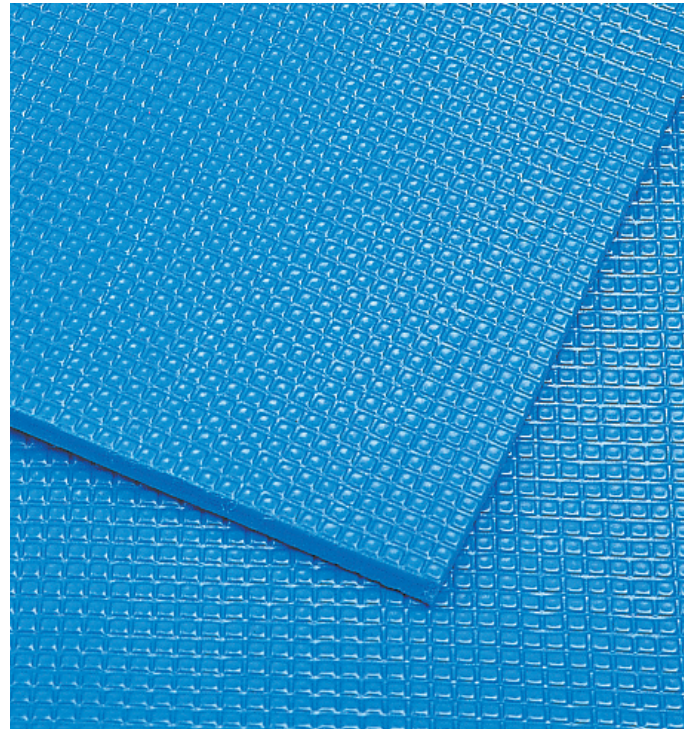

Not suitable for use with Reel Systems

Not hemmed

Help should be on hand to off-load larger covers upon delivery

▲ Extra carriage applies to Spa Covers

### Spa Cover (12mm)

DISCOUNT/ PRODUCT CODE	DESCRIPTION	PRICE EACH
J PSP200	per sq.m.	34.50
J SHPMCOMS	Shaping Surcharge per sq.m.	3.60

## Polyweave Heat Retention Cover

MADE  
TO  
ORDER

HEAVY  
ITEM



Made in the UK

- UV Stabilised bubble material co-extruded onto woven top sheet
- Tear resistant polyolefine top sheet
- For domestic or small commercial pools
- 400 micron
- 0.52kg per sq.m.
- Material width 2.06m
- Despatched in roll form to avoid packing creases
- 3 year pro-rata warranty (UK & Eire only)
- To be shaped on site
- 29°C maximum temperature

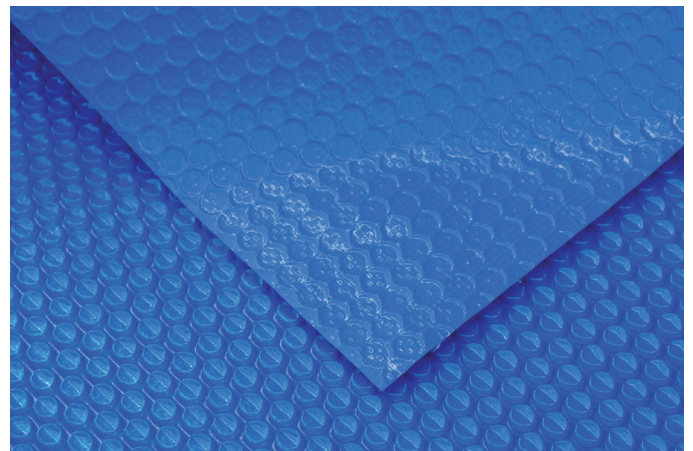

▲ Extra carriage applies to Polyweave Covers

### Polyweave Heat Retention Cover

DISCOUNT/ PRODUCT CODE	DESCRIPTION	PRICE EACH
J PPW100	per sq.m.	13.00
J SHPMCOMS	Shaping Surcharge per sq.m.	3.60
J CUTCOMS	Cut-Out Charge	47.00
J SHPACOMS	Charge for Shaping Bay	39.00

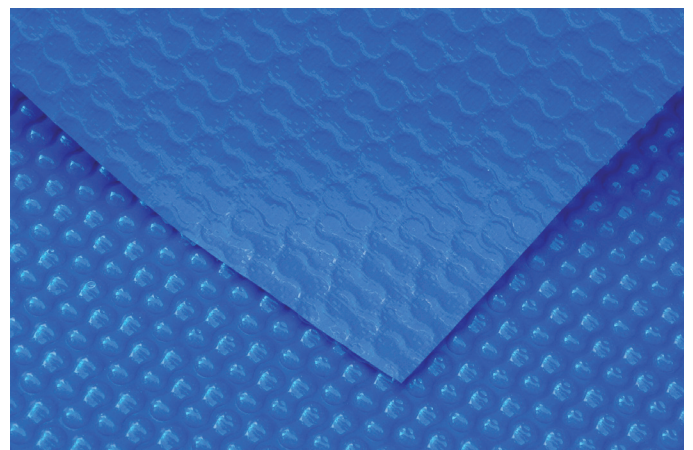

### Polyweave GeoBubble Cover

DISCOUNT/ PRODUCT CODE	DESCRIPTION	PRICE EACH
J PWG100	per sq.m.	13.80

# Commercial Leading Edge & Reinforcing

INSTALL

MADE TO ORDER

HEAVY ITEM



Made in the UK



- Foam filled and reinforced leading edge
- Helps operation of heat retention covers
- Saves wear and tear
- Blue tarpaulin sleeving surrounding a foam inner

- Heat welded and fitted to cover
- Recommended for all covers over 12m long
- Includes all tow ropes and reinforced reel end
- Laid flat during transportation to avoid creasing

## Leading Edge & Reinforcing

DISCOUNT/ PRODUCT CODE	DESCRIPTION	PRICE EACH
J PFA100	Foam Filled Leading Edge and Reinforcing per metre	88.00
J PFA150	Foam Filled Leading Edge per metre	77.00
J PFA275	Reel End Reinforcing per metre	25.50

Above prices include fitting to new covers at time of manufacture

## DIY Reinforcing

DISCOUNT/ PRODUCT CODE	DESCRIPTION	PRICE EACH
J PFA301	DIY Reinforcing Material & Connectors per metre	28.70

To strengthen reel end of cover where the straps connect

## Fixings

DISCOUNT/ PRODUCT CODE	DESCRIPTION	PRICE EACH
J TAR310	Tarpaulin Strap (per linear meter)	11.75
K WEB025	25m Roll of Blue Webbing (25mm)	25.40
K PRD020PFB	Pack of 20 Blue Press Fix Connectors	13.60
K PRD050PFB	Pack of 50 Blue Press Fix Connectors	33.95
K PRD100PFB	Pack of 100 Blue Press Fix Connectors	67.90
K SHAK001	6mm D Shackle	6.90
K HOOK001	Carbine Hook	3.83
K DSH001	Stainless Steel D-Shackle	7.75
K RIN020	Stainless Steel Ring (50mm)	8.90

## Cord & Straps

DISCOUNT/ PRODUCT CODE	DESCRIPTION	PRICE EACH
K COR253	25m of Blue Polycord Roll (5mm)	25.80
K COR251	25m of Heavy Duty Blue Polycord (8mm)	49.15
K COR254	25m of Heavy Duty Blue Polycord (12mm)	47.30
K FITSTRAPS	Attach Strap Set To Cover	12.80

# Light Commercial Leading Edge



Made in the UK

- Can be attached at time of manufacture
- Lightweight
- Cuts down on transport costs
- Can be despatched separately

- Attached on site
- 1.5m tubes and fittings sent as separate package
- Tough PVC coated netting
- Sleeve is self draining and corrosion resistant

## Pre-fitted

DISCOUNT/ PRODUCT CODE	DESCRIPTION	PRICE EACH
J PFA400	7.5m *	250.00
J PFA500	10.5m **	342.00

## DIY

DISCOUNT/ PRODUCT CODE	DESCRIPTION	PRICE EACH
J PFA401	7.5m	225.00
J PFA501	10.5m	312.00

\* for pool sizes up to 8m wide (20m long)  
\*\* for pool sizes 8.01m to 11m wide (30m long)

Covers & Reels

# Slidelock Telescopic Reel



Made in the UK

- Polished stainless steel end stands
  - Anodised aluminium tubes
  - Plastic end bosses and steering wheels
  - Straps connect to tubes by our unique slide and lock fixing
  - Locking device holds the tube in position, stopping the cover from unwinding.
  - Range of different end stands
  - Optional castor pack
- 
- Small Slidelock tubes for 3.05m to 4.57m (4.3m maximum cover width)
  - Large Slidelock tubes for 4.88m to 6.4m (6.1m maximum cover width)

Notes: Reels should be set up to have a maximum 300mm overlap each side.  
 Maximum recommended area of material on both reels is 75sq.m.  
 Cover/tube overlap should be kept to a minimum.  
 Some flexing of the tube may occur with larger covers.



## Accessories

DISCOUNT/ PRODUCT CODE	DESCRIPTION	PRICE EACH
K PRD113	140cm Elastic Cords with Toggle Ends (pack of 8)	16.30
K PRD115	Elasticated Quick Fit Strap Kit (pack of 3)	9.95
G PRD125	Pair of Threaded Deck Anchors	44.00
G PRD130	Additional Height of 300mm per pair	30.00
G PRD150	Pack of 6 Castors (Type 2)	100.00

## Accessories

DISCOUNT/ PRODUCT CODE	DESCRIPTION	PRICE EACH
K PRD20040	Pack of 10 Universal Strap Sets (individually packed)	73.00
K PRD020PFB	Pack of 20 Blue Press Fix Connectors	13.60
K PRD050PFB	Pack of 50 Blue Press Fix Connectors	33.95
K PRD100PFB	Pack of 100 Blue Press Fix Connectors	67.90
K SLC00110	Pack of 10 Blue Slidelock Clips	12.00
K SLC00210	Pack of 10 Black Slidelock Clips	12.00



Strap Kit – PRD115

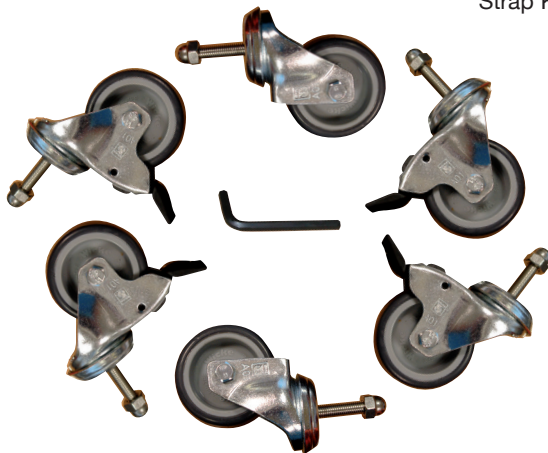

Castor Pack – PRD150



Elastic cords with toggle ends Kit – PRD113

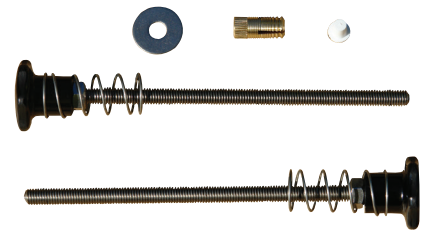

Deck Anchors – PRD125



Slidelock Clip, Blue – SLC00110



Slidelock Clip, Black – SLC00210



Press Fix Connector – PRD020PFB

## Wedges (pack of 10)

DISCOUNT/ PRODUCT CODE	DESCRIPTION	PRICE EACH
K RTS100	Reel Thumb Screws	15.80
K WED100	Large Inner Wedges	15.80
K WED200	Small Outer Wedges	15.80

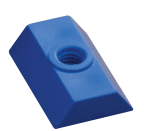
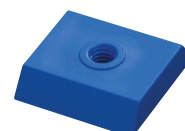

RTS100 – WED100 – WED200

# Slidelock Telescopic Reel

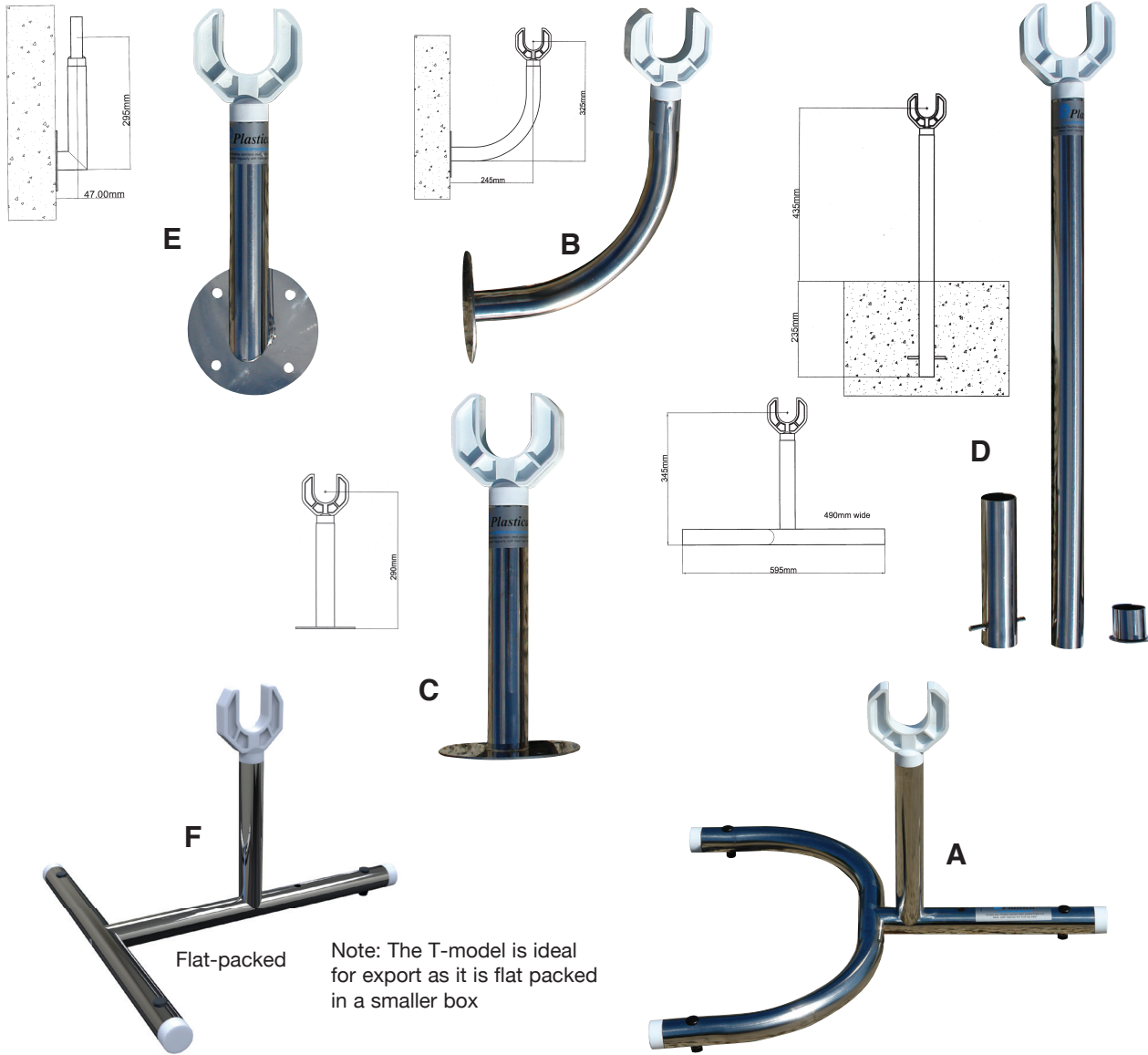

Note: The T-model is ideal for export as it is flat packed in a smaller box

Covers & Reels

## Small Slidelock (complete)

DISCOUNT/ PRODUCT CODE	DESCRIPTION	PRICE EACH
G PRD200K	Standard (A)	573.50
G PRD201K	Wall Mounted (B)	573.50
G PRD202K	Base Plate Mounted (C)	573.50
G PRD203K	Sleeve Mounted (D)	573.50
G PRD204K	Side Wall Mounted (E)	573.50
G PRD200TWK	T-Model Space Saver Flat-packed (F)	573.50

## Large Slidelock (complete)

DISCOUNT/ PRODUCT CODE	DESCRIPTION	PRICE EACH
G PRD205K	Standard (A)	617.50
G PRD206K	Wall Mounted (B)	617.50
G PRD207K	Base Plate Mounted (C)	617.50
G PRD208K	Sleeve Mounted (D)	617.50
G PRD209K	Side Wall Mounted (E)	617.50
G PRD205TWK	T-Model Space Saver Flat-packed (F)	617.50

Any fixed domestic end stands can have an additional height added at the price coded.

Extensions up to an added 300mm are 1x PRD130 charge, over this and to a maximum of 500mm, 2x PRD130 are to be charged.

Please note: dimensions on extensions refer to metalwork only.

All plate fixings are 130mm Ø

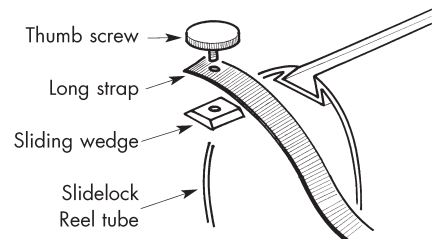
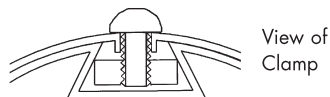
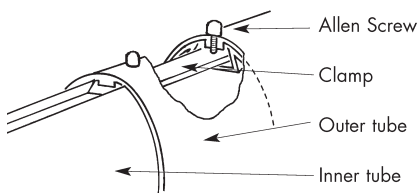

# Slidelock Reel with 3:1 Reduction Gearbox



- 3:1 reduction makes winding reels easy
- Aerospace industry gearing for strength & reliability

## Small Slidelock (complete)

DISCOUNT/ PRODUCT CODE	DESCRIPTION	PRICE EACH
G2 PRD200RGK	Standard (A) – ex stock	778.00
G2 PRD201RGK	Wall Mounted (B) *	778.00
G2 PRD202RGK	Base Plate Mounted (C) *	778.00
G2 PRD203RGK	Sleeve Mounted (D) *	778.00
G2 PRD204RGK	Side Wall Mounted (E) *	778.00
G2 PRD200TWRGK	T-Model (F)	778.00

## Large Slidelock (complete)

DISCOUNT/ PRODUCT CODE	DESCRIPTION	PRICE EACH
G2 PRD205RGK	Standard (A) – ex stock	797.00
G2 PRD206RGK	Wall Mounted (B) *	797.00
G2 PRD207RGK	Base Plate Mounted (C) *	797.00
G2 PRD208RGK	Sleeve Mounted (D) *	797.00
G2 PRD209RGK	Side Wall Mounted (E) *	797.00
G2 PRD205TWRGK	T-Model (F)	797.00

\* Made to order – allow two days.



# Reduction Gearbox



- Revolutionary product
- Fits both of Plastica Slidelock domestic reels
- Discreet and made to match the original boss
- Reduction makes winding reels easy
- Retro-fits to existing Slidelock reels on site
- Comes complete with all necessary tools and instructions
- Aerospace industry gearing for strength & reliability

## Reduction gearbox

DISCOUNT/ PRODUCT CODE	DESCRIPTION	PRICE EACH
K SMVOR10	Reduction gearbox for Slidelock Reel	278.00

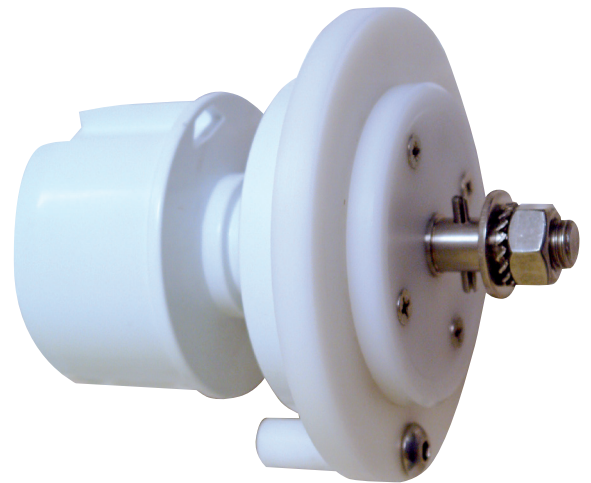



# Power Pack 100



- Semi-automatic motorisation for domestic reels up to 75sq.m
- Motor fits Plastica Slidelock reel (& Reel Easy using adaptors)
- With built-in Brake, Limit Switches & Variable Start Delay timer
- Includes hand held remote control with up to 30m range
- S.E.L.V. can be mounted in pool area
- Built in battery back-up & 24v DC Power Supply/Charger
- Powerful motor with overload protection and 15m of cable.
- Complies with existing wiring regulations
- Safe Extra Low Voltage Control Box for safety (24V DC)
- Charger with 1.8m cable requires 6Amp 230v AC socket

Notes: Not suitable for shaped pools. Reel must be permanent-ly fixed down and positioned directly above the water to avoid drag.

## Power Pack 100

DISCOUNT/ PRODUCT CODE	DESCRIPTION	PRICE EACH
K PRD604K	24v Motor System (for Slidelock Reel '97 on)	2295.00

## Power Pack 100 Options

DISCOUNT/ PRODUCT CODE	DESCRIPTION	PRICE EACH
K PRD605RB	Key Switch with 15m cable	117.00

Microprocessor controlled Control Panel with LCD display that has multiple menu options:

- Variable current limit
- Jammed cover reversing function
- Maximum of 8 radio remote controllers (1 supplied)
- Variable delay for button operated closing
- Variable delay for transmitter closing
- Selectable charger type



Covers  
& Reels

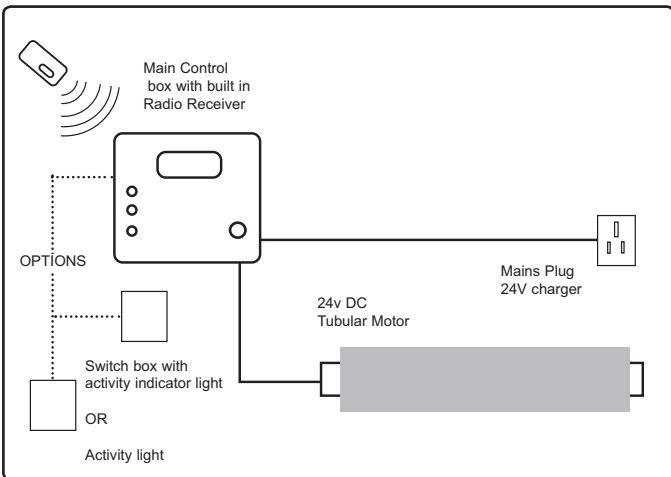

# Helios™ Solar Reel



- Totally self contained motorised reel
- For small domestic outdoor Solar covers
- SELV 12V d.c. operation
- Automatic stopping limits
- Comes complete with end stands and tube set
- Simple 3-way key operation
- Solar panel trickle charging



PRICE HELD FOR 2017



- Small Slidelock style tubes for 3.05m to 4.57m (4.3m maximum cover width)
- Large Slidelock style tubes for 4.88m to 6.1m (5.8m maximum cover width)

Notes: Reels should be set up to have a 150 to 300mm overlap each side.

Maximum recommended area of material on both reels is 60sq.m. Cover/tube overlap should be kept to a minimum. Some flexing of the tube may occur with larger covers.

## Helios™ Solar Reel

DISCOUNT/ PRODUCT CODE	DESCRIPTION	PRICE EACH
H PRD300K	Small Helios 3.05 to 4.57 (10' - 15')	1348.00
H PRD305K	Large Helios 4.88 to 6.1 (16' - 20')	1383.00

## Premium Reel System

- Domestic use
- Anti-spin locking device on wheels
- Smooth action with sturdy telescopic tube
- Complete with connectors for new or existing covers
- Tube extends from 3.66m to 5.49m
- Maximum area of cover 50 sq.m.



### In-ground

DISCOUNT/ PRODUCT CODE	DESCRIPTION	PRICE EACH
G2 ERC300	In-Ground	376.00

- Mobile reel system, 340mm high
- Mobile end stand with 2 wheels
- Static end stand



### Above Ground

DISCOUNT/ PRODUCT CODE	DESCRIPTION	PRICE EACH
G2 ERC310	Above Ground	409.00

- 2 fixed stands
- Height adjustable from 150mm to 220mm
- Fixes to the pool side

### Decking

DISCOUNT/ PRODUCT CODE	DESCRIPTION	PRICE EACH
G2 ERC320	Decking	458.00

- 340mm high
- Ideal for wooden pools or decked surrounds
- One fixed end fastens to the surround
- Universal joint enables reel to be moved away from pool side

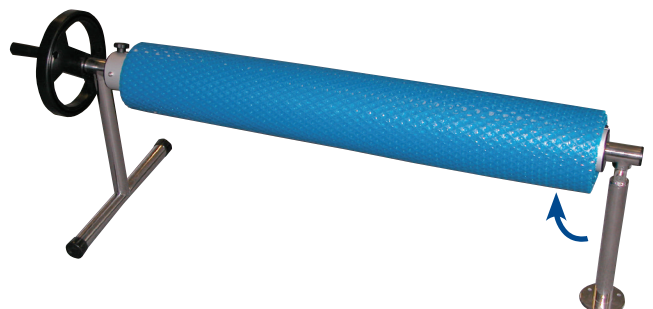

# Reflective Storage Cover



Made in the UK



- Reduces the temperature of a stored cover by over 30°C
- Extend the life of your cover by protecting from sun damage
- UV stabilised

## Reflective Storage Cover

DISCOUNT/ PRODUCT CODE	DESCRIPTION	PRICE EACH
K PSC801	25m Roll x 1m Wide	84.50
K PSC820	6m Length	23.50
K PRD115	Elasticated Quick Fit Strap Kit (pack of 3)	9.95
K PRD113	140cm Elastic Cord with Toggle Ends (pack of 8)	16.30

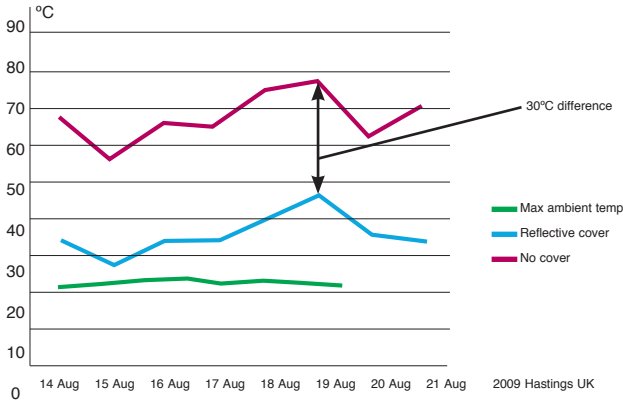

Permanent damage will occur to the pool cover above 90°C



Covers  
& Reels

# Solar Protector Sheet



## Solar Protector Sheet

DISCOUNT/ PRODUCT CODE	DESCRIPTION	PRICE EACH
R PSC901	25m x 1.22m Roll	59.50
R PSC920	6m x 1.22m	15.60
K PRD115	Elasticated Quick Fit Strap Kit (pack of 3)	9.95
K PRD113	140cm Elastic Cord with Toggle Ends (pack of 8)	16.30



Strap Kit – PRD115



Elastic Cord with Toggle Ends – PRD113

# Deluxe Reel Protector Cover



## White

DISCOUNT/ PRODUCT CODE	DESCRIPTION	PRICE EACH
G2 PRD215 Small		117.00
G2 PRD218 Medium		129.00
G2 PRD222 Large		144.00
G2 PRD226 Extra Large		159.00

## Blue

DISCOUNT/ PRODUCT CODE	DESCRIPTION	PRICE EACH
G2 PRD315 Small		117.00
G2 PRD318 Medium		129.00
G2 PRD322 Large		144.00
G2 PRD326 Extra Large		159.00

- Reinforced PVC
- Protects reel system from the elements
- Made to allow for 355mm steering wheel
- Blue – keeps rain & frost from damaging reel system left outside
- White – Reflects sun's rays & harmful UV to protect reel & cover
- Small – reels up to 15'
- Medium – reels up to 18'
- Large – reels up to 22'
- Extra Large – reels up to 26'



Note: white protector cover comes with blue press fix connectors

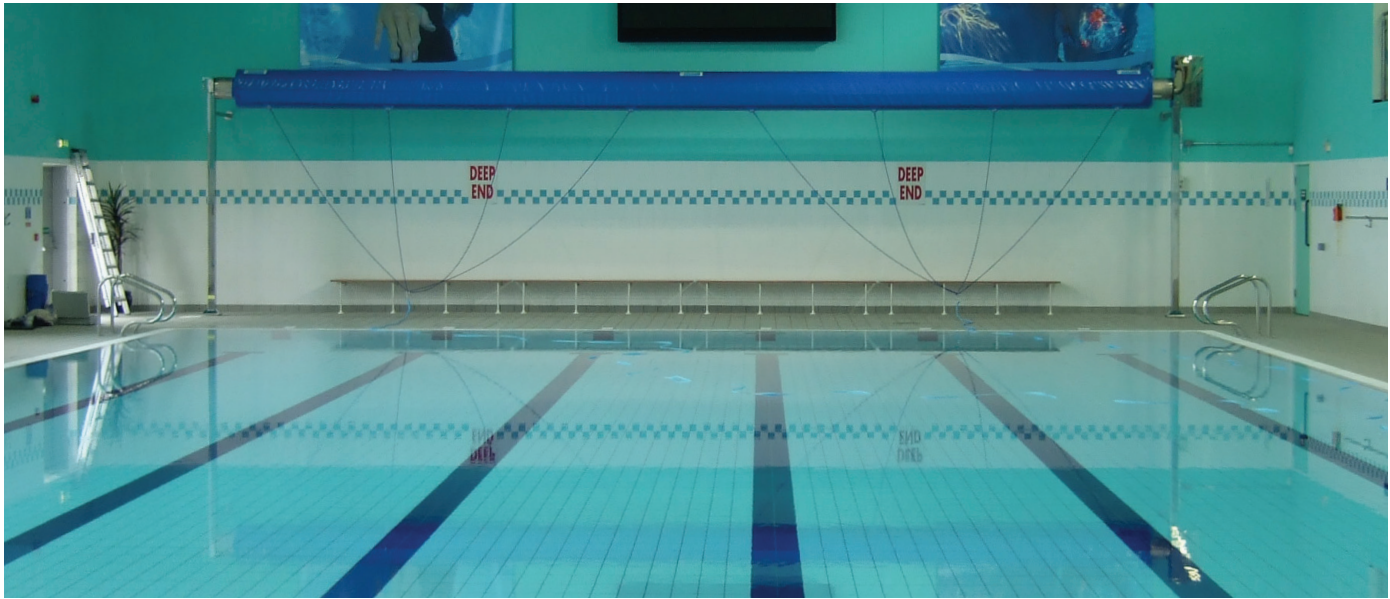

## Fixed Manual

INSTALL    MADE TO ORDER    HEAVY ITEM

- Suitable for most smaller commercial pools
- Nylon end bosses and anodised tube
- Optional reduction gearbox
- Highly polished stainless steel end stands as standard
- White powder coating available on request
- Approximate weight of each end stand including bearing is 10kg plus 2kg extra per 240mm run of tube

### Tube Packs

DISCOUNT/ PRODUCT CODE	DESCRIPTION	PRICE EACH
J PCR012 ▲ 3.66m (12')		617.00
J PCR014 ▲ 4.27m (14')		657.00
J PCR016 ▲ 4.88m (16')		698.00
J PCR018 ▲ 5.49m (18')		740.00
J PCR020 ▲ 6.10m (20')		781.00
J PCR022 ▲ 6.71m (22')		823.00
J PCR024 ▲ 7.32m (24')		869.00
J PCR026 ▲ 7.92m (26')		911.00
J PCR028 ▲ 8.53m (28')		952.00
J PCR030 ▲ 9.14m (30')		999.00
J PCR032 ▲ 9.75m (32')		1041.00

### Surcharges

	Length in metres						
	10	15	20	25	30	33	50
PCR012	0%	0%	0%	0%	0%	0%	A
PCR014	0%	0%	0%	0%	0%	0%	A
PCR016	0%	0%	0%	0%	0%	0%	A
PCR018	0%	0%	0%	0%	0%	0%	A
PCR020	0%	0%	0%	0%	0%	0%	A
PCR022	0%	0%	0%	0%	0%	A	A
PCR024	0%	0%	0%	0%	A	A	
PCR026	0%	0%	0%	A	A		
PCR028	0%	0%	A	A			
PCR030	0%	A	A				
PCR032	0%	A	A				

### End Stands

DISCOUNT/ PRODUCT CODE	DESCRIPTION	PRICE EACH
J PCR002	Baseplate (A)	325.00
J PCR004	Wallmount (B)	325.00
J PCR006	Sleeve-Mount (C)	205.00
J PCR120	0.3m / 1' Added Height To Reel System (per pair)	81.00

Two End Stands required for every Reel System

### Fixed Reel with Reduction Gearbox

There is an additional cost of £914.00 per reel when a gearbox is required (covers over 140 sq.m.)

Please add a "G" to the end of the reel code when ordering – ie. PCR012G

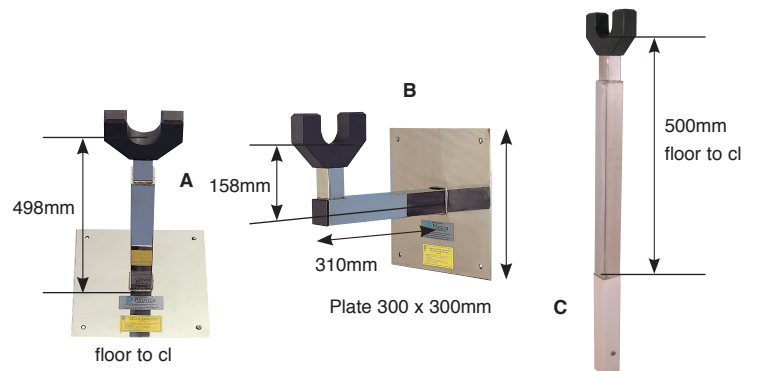

For a quote contact Customer Services on 01424 857802 or email [info@plasticpools.net](mailto:info@plasticpools.net)

Delivery for commercial products can be costly. Always ask for a quotation before ordering.  
Reels should be at least 460mm longer than the cover.  
Help should be on hand to off-load larger covers upon delivery



- For pools up to 13.7m wide
- Ideal when two covers are necessary for pools over 9.14m wide
- Dual tubes take two covers supported by a pair of mobile end stands

- Detachable cover with quick-fit snap connectors
- Stainless steel frame with nylon end bosses
- 127mm diameter aluminium tube
- 152mm stainless steel braked castors

## Piggyback Mobile

DISCOUNT/ PRODUCT CODE	DESCRIPTION		PRICE EACH
J PPB012 ▲ 3.66m (12')		50m	2861.00
J PPB014 ▲ 4.27m (14')		50m	2984.00
J PPB016 ▲ 4.88m (16')		50m	3072.00
J PPB018 ▲ 5.49m (18')		50m	3161.00
J PPB020 ▲ 6.10m (20')		50m	3249.00
J PPB022 ▲ 6.71m (22')		34m	3338.00
J PPB024 ▲ 7.32m (24')		25m	3443.00

## Quick Release Strap Kit

DISCOUNT/ PRODUCT CODE	DESCRIPTION	PRICE EACH
K PPB20013	5' Strap	9.30
K PPB20014	7' Strap	9.30

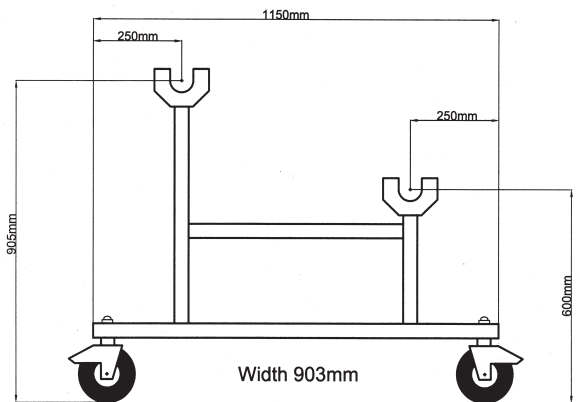

## Piggyback with Reduction Gearbox

There is an additional cost of £1828.00 per reel when gearboxes are required.

Please add a "G" to the end of the reel code when ordering – ie. PPB012G

For a quote contact Customer Services on 01424 857802 or email [quote@plasticapools.net](mailto:quote@plasticapools.net)

Delivery for commercial products can be costly. Always ask for a quotation before ordering.  
Reels should be at least 460mm larger than the cover.  
Help should be on hand to off-load larger covers upon delivery



- For smaller commercial pools
- Stainless steel frame with nylon end bosses
- 127mm diameter aluminium tube
- 127mm braked castors

## Mobile Reel System

DISCOUNT/ PRODUCT CODE	DESCRIPTION		PRICE EACH
J PPB212 ▲	3.66m (12')	50m	1882.00
J PPB214 ▲	4.27m (14')	50m	1953.00
J PPB216 ▲	4.88m (16')	50m	2000.00
J PPB218 ▲	5.49m (18')	50m	2047.00
J PPB220 ▲	6.10m (20')	50m	2096.00
J PPB222 ▲	6.71m (22')	34m	2143.00
J PPB224 ▲	7.32m (24')	25m	2194.00
J PPB226 ▲	7.92m (26')	20m	2243.00
J PPB228 ▲	8.53m (28')	17m	2291.00
J PPB230 ▲	9.14m (30')	14m	2339.00
J PPB232 ▲	9.75m (32')	10m	2389.00

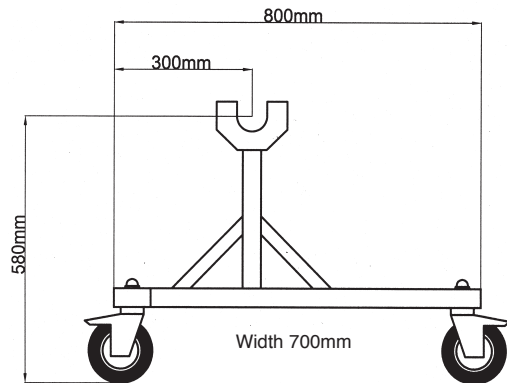

Note: If cover length exceeds maximum as indicated then 165mm aluminium tube is required. Phone Customer Services for a quote. Reduction gearbox recommended for covers over 140 sq.m.

## Mobile Reel with Reduction Gearbox

There is an additional cost of £914.00 per reel when a gearbox is required.

Please add a "G" to the end of the reel code when ordering – ie. PPB212G



**Bespoke Sales LTD.**  
 sales@bespokepoolsales.co.uk  
 (UK) Tel: 1 001268 710425

For a quote contact Customer Services on 01424 857802 or email quote@plasticpools.net

Delivery for commercial products can be costly. Always ask for a quotation before ordering.  
 Reels should be at least 460mm larger than the cover.  
 Help should be on hand to off-load larger covers upon delivery

# Full Commercial Stanchion Motorised

INSTALL

MADE  
TO  
ORDER

HEAVY  
ITEM



Made in the UK



- Ultra quiet motors with soft start - soft stop mechanism
- 304mm diameter stainless steel tubing
- Maximum cover capacity of 600 sq.m.
- 14m maximum tube length.
- Key switch and remote control operation
- Auto stop end of run settings



For a quote contact Customer Services  
on 01424 857802 or  
email [quote@plasticpools.net](mailto:quote@plasticpools.net)



Covers  
& Reels



# Light Commercial Motorised



- Ideal for small commercial swimming pools
- Ultra quiet motors with soft start - soft stop mechanism
- Manufactured from stainless steel
- Maximum cover size 170 sq.m.
- 9m maximum standard tube length
- 168mm tube diameter
- Key switch and remote control
- Auto stop end of run settings



For a quote contact Customer Services on 01424 857802 or email [quote@plasticpools.net](mailto:quote@plasticpools.net)

# Wind Resistant Wires



- Recommended for all outdoor pool covers
- Helps protect from lifting in winds up to Gale Force 5 (30km/h)
- Stainless steel wire fitted inside hemming and fixed at pool ends
- Requires wires on lengths and widths, together with two of each end fitting kit.

Notes: Wires can only be fitted at the time of manufacture. Not guaranteed to make a pool cover windproof. Covers should be stored on a reel system in winds over Gale Force 5 (30km/h)

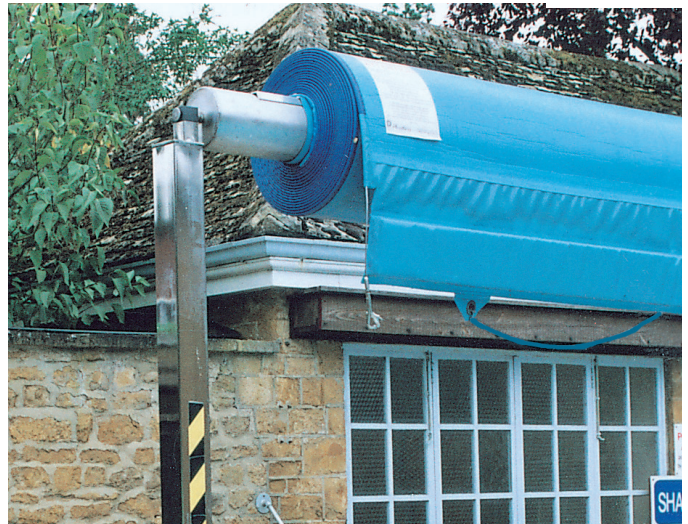

## Wind Resistant Wires

DISCOUNT/ PRODUCT CODE	DESCRIPTION	PRICE EACH
J WRW001	Wind Wires per linear meter	POA
K WRT001	Towing End Fitting Kit	POA
K WRR001	Reel End Fitting Kit	POA

Towing End – Length Fixing



Towing End – Width Fixing



Reel End – Length Fixing

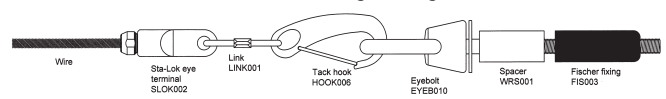

Reel End – Width Fixing



For a quote contact Customer Services on 01424 857802 or email [quote@plasticpools.net](mailto:quote@plasticpools.net)



## Venetian™ Covers

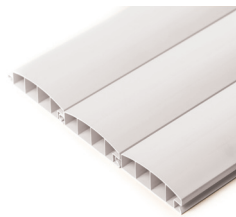
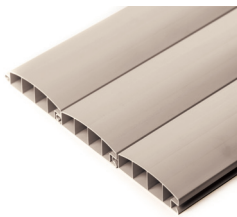
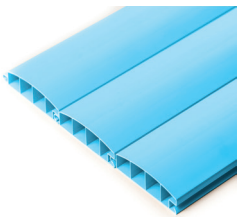

83mm

- Systems available including support beam and duckboards
- Installation service available for all models

Supplementary charges apply if:

- Pool exceeds certain dimensions
- Cover has a shaped area
- Order is for slats only
- Order involves split shipments
- Pool has deeper than standard pit

Notes: Prices are ex-works and do not include delivery, installation or power cables.

Wood should be treated by the customer with a preservative or stain.

The prices on the following pages are a guide only and the discount group is V.

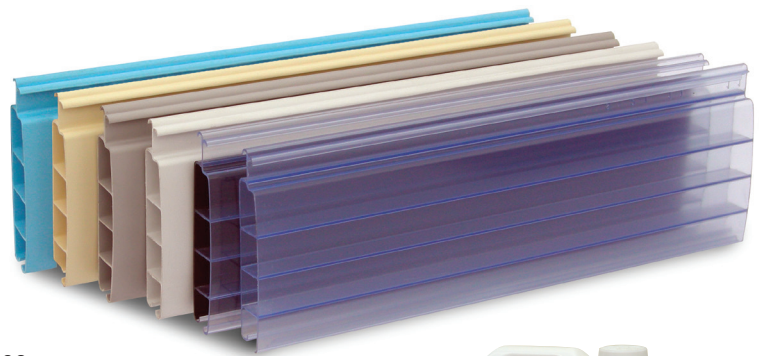

60mm



### Slatted Cover Cleaner

DISCOUNT/ PRODUCT CODE	DESCRIPTION	PRICE EACH
T3 RCH506	2 x 5 Litre Relax Slatted Cover Cleaner	48.50

# Pit Type Venetian™ Covers

INSTALL

SPECIAL  
ORDER

HEAVY  
ITEM

- Hidden from view
- Key switch operation
- Submerged automatic cover system
- No need for a dry motor pit
- Reliable and quick to install
- Hardwood and Composite Duckboards

## Pit Type Venetian™ Cover Complete Systems – Standard Sizes

Pool Size	Mech. c/w 60mm/83mm Standard	60mm Transparent	60mm Solar	60mm Polycarbonate	83mm Polycarbonate	Beam 304	Beam 316	Rear Duckboards support	Beam Duckboards Support	Timber Duckboards	Nett Price SS Motor Upgrade
3m x 6m	6691.00	504.00	540.00	1404.00	1584.00	903.00	1312.00	138.00	138.00	1026.00	2020.00
10 x 20	7169.00	532.00	570.00	1482.00	1672.00	903.00	1312.00	138.00	138.00	1026.00	2020.00
3.5m x 7m	7169.00	700.00	750.00	1950.00	2200.00	992.00	1400.00	160.00	160.00	1198.00	2020.00
12 x 24	7709.00	756.00	810.00	2106.00	2376.00	1080.00	1487.00	183.00	183.00	1370.00	2020.00
4m x 8m	7709.00	896.00	960.00	2496.00	2816.00	1080.00	1487.00	183.00	183.00	1370.00	2020.00
14 x 28	8326.00	1036.00	1110.00	2886.00	3256.00	1341.00	1851.00	205.00	205.00	1541.00	2020.00
4.5m x 9m	8326.00	1148.00	1230.00	3198.00	3608.00	1341.00	1851.00	205.00	205.00	1541.00	2020.00
15 x 30	8986.00	1176.00	1260.00	3276.00	3696.00	1437.00	1949.00	229.00	229.00	1713.00	2020.00
16 x 32	8986.00	1344.00	1440.00	3744.00	4224.00	1437.00	1949.00	229.00	229.00	1713.00	2020.00
5m x 10m	8986.00	1400.00	1500.00	3900.00	4400.00	1437.00	1949.00	229.00	229.00	1713.00	2020.00
18 x 36	9718.00	1708.00	1830.00	4758.00	5368.00	1536.00	2150.00	252.00	252.00	1883.00	2020.00
5.5m x 11m	9718.00	1708.00	1830.00	4758.00	5368.00	1536.00	2150.00	252.00	252.00	1883.00	2020.00
6m x 12m	10514.00	2016.00	2160.00	5616.00	6336.00	1819.00	2431.00	274.00	274.00	2057.00	2020.00
20 x 40	12383.00	2100.00	2250.00	5850.00	6600.00	2020.00	2839.00	298.00	298.00	2227.00	2020.00

Pricing for standard sizes: Choose pool size then add slat option, beam and duckboards as required.

For more information or an individual quote please contact Jody Perkins on 01424 857743 (jody.perkins@plasticpools.net)

▲ Fixed carriage is applicable on the above prices.



# Pit Type Venetian™ Covers

INSTALL SPECIAL ORDER HEAVY ITEM

- Aluminium axle (Stainless Steel available on request)
- Low voltage motor
- Requires no cement-bedded through-wall fittings (no risk of leaks)

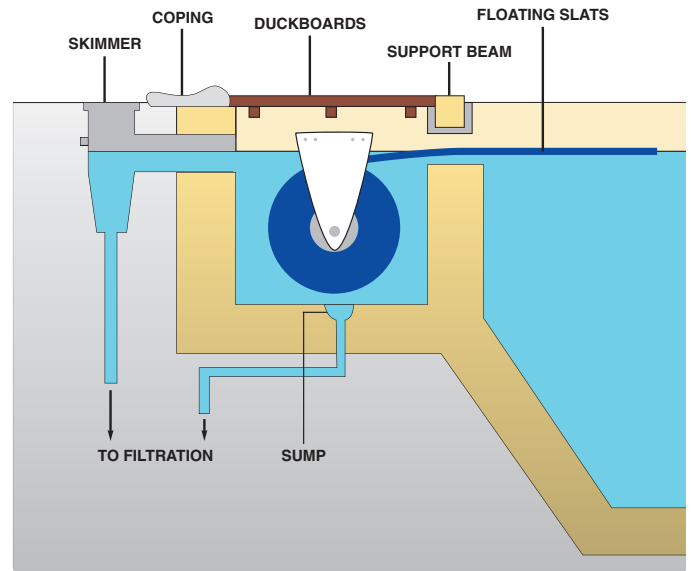

Pit Type Venetian Layout

## Pit Type Venetian™ Cover – Non Standard

Length	3m	3.5m	4m	Width 4.5m	5m	5.5m	6m	6.5m	7m
5	6561.00	6785.00							
6	6691.00	6952.00	7202.00	7585.00					
7	6883.00	7169.00	7458.00	7781.00					
8	7072.00	7560.00	7709.00	8028.00	8346.00	8753.00			
9	7263.00	7610.00	7962.00	8326.00	8668.00	9017.00	9367.00		
10	7442.00	7836.00	8222.00	8603.00	8986.00	9367.00	9748.00	10811.00	11867.00
11	7623.00	8064.00	8476.00	8889.00	9303.00	9718.00	10131.00	11225.00	12293.00
12	7805.00	8291.00	8730.00	9179.00	9621.00	10069.00	10514.00	11681.00	14844.00
13	7986.00	8517.00	8991.00	9468.00	9939.00	10416.00	11218.00	12383.00	15588.00
14			9244.00	9754.00	10257.00	10764.00	11577.00	14825.00	16034.00
15			9503.00	10042.00	10574.00	11111.00	13958.00	15233.00	16481.00
16			9759.00	10330.00	10892.00	11460.00	14369.00	15658.00	16927.00
17							15119.00	16049.00	17283.00
18							15539.00	16585.00	17610.00

## Pit Type Venetian™ Cover – Beams

Length	3m	3.5m	4m	Width 4.5m	5m	5.5m	6m	6.5m	7m
304 SS BEAM	903.00	992.00	1080.00	1341.00	1437.00	1536.00	1819.00	2020.00	2628.00
316 SS BEAM	1312.00	1400.00	1487.00	1851.00	1949.00	2150.00	2431.00	2839.00	3446.00
SS SUPPORT	138.00	160.00	183.00	205.00	229.00	252.00	274.00	298.00	320.00
SS SUPPORT on beam	138.00	160.00	183.00	205.00	229.00	252.00	274.00	298.00	320.00
TIMBER	1026.00	1198.00	1370.00	1541.00	1713.00	1883.00	2057.00	2227.00	2396.00

Pricing for non-standard sizes: choose correct price depending on size. Add beam and duckboards as required. Please see slat charges for options and supplement prices.

▲ Fixed carriage is applicable on the above prices.

# Deluxe Enclosed Venetian™ Cover

INSTALL

SPECIAL ORDER

HEAVY ITEM



• Ideal for new-build or retro-fit

• Above ground installation with automatic controls

• White PVC or hardwood

## Deluxe Enclosed Venetian™ Complete Systems – Standard Sizes

Length	Width								
	3m	3.5m	4m	4.5m	5m	5.5m	6m	6.5m	7m
5	5950.00	6143.00	6181.00	6469.00					
6	6062.00	6283.00	6503.00	6831.00					
7	6228.00	6474.00	6722.00	7000.00					
8	6391.00	6810.00	6939.00	7213.00	7487.00	7835.00	7881.00	8660.00	9587.00
9	6555.00	6853.00	7160.00	7468.00	7762.00	8063.00	8365.00	9183.00	10149.00
10	6707.00	7047.00	7378.00	7705.00	8035.00	8363.00	8692.00	9707.00	10712.00
11	6865.00	7243.00	7597.00	7953.00	8309.00	8665.00	9020.00	10062.00	11079.00
12	7021.00	7438.00	7817.00	8202.00	8583.00	8966.00	9350.00	10454.00	11536.00
13	7177.00	7634.00	8038.00	8441.00	8856.00	9265.00	9956.00	11066.00	12175.00
14	7419.00	7915.00	8259.00	8696.00	9130.00	9566.00	10263.00	11422.00	12559.00
15	7660.00	8198.00	8481.00	8967.00	9403.00	9865.00	10576.00	11771.00	12943.00
16	7901.00	8479.00	8701.00	9191.00	9675.00	10164.00	10928.00	12138.00	13324.00
17	8142.00	8761.00	9023.00	9554.00	10078.00	10606.00	11574.00	12473.00	13633.00
18	9350.00	9041.00	9344.00	9916.00	10480.00	11048.00	11936.00	12935.00	13914.00

## Benches

	Width								
	3m	3.5m	4m	4.5m	5m	5.5m	6m	6.5m	7m
PVC Bench in White	1452.00	1525.00	1729.00	1982.00	2156.00	2371.00	2681.00	2923.00	3457.00
Wooden Bench in Iroko	1484.00	1707.00	1937.00	2219.00	2416.00	2654.00	3002.00	3274.00	3872.00

Pricing: Choose pool size, select bench type and slat option from surcharges below to calculate required price. ▲ Fixed carriage is applicable on the above prices.

## SLAT CHARGES

For slat upgrades add the supplement price to the standard cost for complete systems.



PVC Standard Slats 60/83mm	
Price per m <sup>2</sup>	Supplement Price per m <sup>2</sup>
62	0



Polycarbonate Standard Colours 60mm	
Price per m <sup>2</sup>	Supplement Price per m <sup>2</sup>
134	78



PVC Transparent Slats 60mm	
Price per m <sup>2</sup>	Supplement Price per m <sup>2</sup>
85	28



Polycarbonate Standard Colours 83mm	
Price per m <sup>2</sup>	Supplement Price per m <sup>2</sup>
144	88



PVC Solar 60mm	
Price per m <sup>2</sup>	Supplement Price per m <sup>2</sup>
86	30



Polycarbonate Solar	
Price per m <sup>2</sup>	Supplement Price per m <sup>2</sup>
165	110

Covers & Reels

# Wooden Poolsaver™ Cover

INSTALL

SPECIAL ORDER

HEAVY ITEM



Made in the UK



Covers & Reels

- Flush fit brass anchors
- Stainless Steel ratchets
- Easy to install
- Made from UV Stabilised PVC coated Polyester
- Beige non-marking underside on all cover colours



## Poolsaver™ Manual Safety Cover

DISCOUNT/ PRODUCT CODE	DESCRIPTION	PRICE EACH
V	Poolsaver Manual Safety Cover per m <sup>2</sup>	52.00
V	LPDA001 Low Profile Deck Anchor	7.56
V	PIN002 Decking Fixings (for decked pools)	5.50
D	PSL600AKR Removable Ladder for safety cover	365.00



## Standard Size Wooden Poolsaver™ Covers\*

POOL SIZE	APPROX. COVER SIZE	PRICE
Knightsbridge / Small Eco	4.213m x 4.213m	936.00
Hampstead / Large Eco	5.600m x 5.600m	1612.00
Belgravia	6.082m x 4.212m	1335.00
Bayswater	7.082m x 4.212m	1560.00
Westminster	8.719m x 5.129m	2340.00
Exercise	4.434m x 2.994m	676.00
Chelsea	10.518m x 5.518m	3016.00

▲ Fixed carriage is applicable on the above prices (unless purchased and delivered with pool)

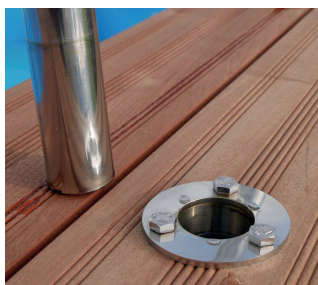

PSL600AKR Removable Ladder



PIN002 Decking Fixings

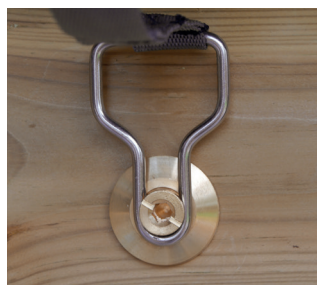

LPDA001 Low Profile Anchor



Stainless Steel Ratchet

# Pool saver™ Manual Safety Cover

INSTALL SPECIAL ORDER HEAVY ITEM  Made in the UK

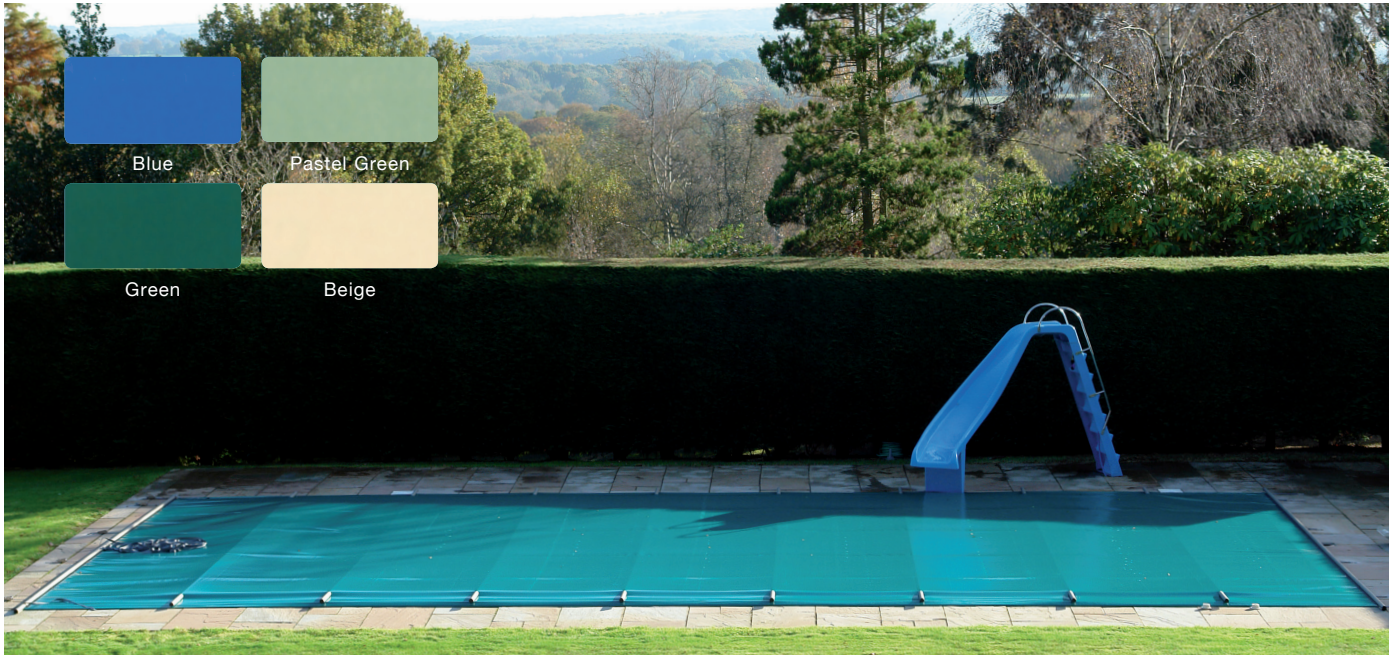

- Easy to install
- Made from UV stabilised PVC coated polyester
- Extra reinforced underside reduces wear from coping stones
- Supplied complete with manual winder. Two winders supplied for covers 5m x 10m and over
- Cover should overhang by 30cm all round pool
- Beige - non-marking underside on all cover colours

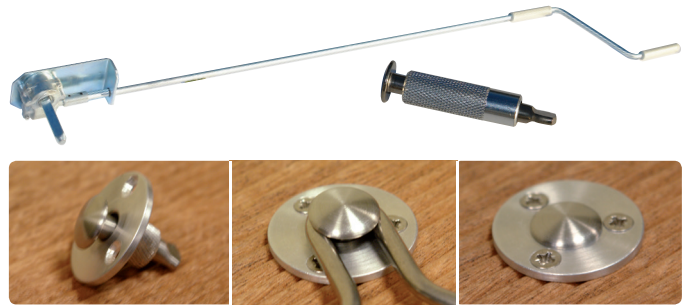

Covers & Reels

Standard size Pool saver™ Covers*			
	POOL SIZE	APPROX. COVER SIZE	PRICE
V ▲	12' x 24'	14' x 26' 34m <sup>2</sup>	1275.00
V ▲	14' x 28'	16' x 30' 45m <sup>2</sup>	1687.50
V ▲	15' x 30'	17' x 32' 51m <sup>2</sup>	1912.50
V ▲	16' x 32'	18' x 34' 57m <sup>2</sup>	2137.50
V ▲	18' x 36'	20' x 38' 71m <sup>2</sup>	2662.50
V ▲	20' x 40'	21'6" x 41'3" (Maximum) 83m <sup>2</sup>	3112.50
	Roman End on Width	Up to 3.5m diameter	475.00

Pool saver™ Manual Safety Cover		
DISCOUNT/PRODUCT CODE	DESCRIPTION	PRICE EACH
V ▲	Pool saver Manual Safety Cover per m <sup>2</sup>	37.50
V ▲	Step Section on width of pool up to 3.5m dia	475.00
V ▲	Step Section on width of pool over 3.5m dia	525.00
V ▲	APF100 Manual Cover Winder (Spare part)	220.50
V ▲	PIN001 14mm Ground Fixing Pin (Spare part)	5.50
V ▲	PIN002 Decking Fixings	5.50

▲ Extra carriage. Please contact Customer Services on 01424 857802 for a delivery quote.

Minimum price will be £1190.00 for pools smaller than 12' x 24'.

[Call Customer Services 01424 857802 for a product quote](tel:01424857802)

## Rolltrot Cover Winding System

SPECIAL ORDER

- Assists with opening and closing of the pool cover
- Wired remote control
- Complete with battery charger
- Direct replacement for the Droopi and Easy Pro 4

Rolltrot		
DISCOUNT/PRODUCT CODE	DESCRIPTION	PRICE EACH
APF500K	When purchased with cover	700.00



Note: Prices above are nett – trade discounts are not available for this product

# Pool saver Hydraulic Safety Cover

INSTALL SPECIAL ORDER HEAVY ITEM  Made in the UK



- Independent hydraulic motors – quiet operation with no end-of-run settings.
- Self adjusting compensator keeps the cover square
- Keeps your pool ready to use and free from debris
- Saves money by sealing in the heat
- Automatic operation from keyswitch
- Plastica installation available



Call Jody on 01424 857743 for a quotation



In-wall Track

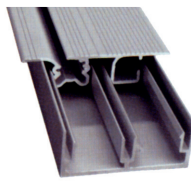

Flush Track

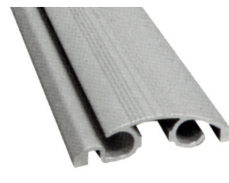

Surface Mount  
Domed Track





# Pool saver Tracker Safety Cover

INSTALL

SPECIAL ORDER

HEAVY ITEM



Made in the UK



- Manual operation
- Easy to install
- Made from UV stabilised PVC coated polyester
- Available in a choice of nine colours
- Gear reduction unit for easy opening of pool
- Option of flush or surface mount track

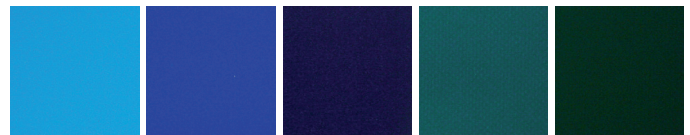

Light Blue   Royal Blue   Cobalt Blue   Green   Dark Green

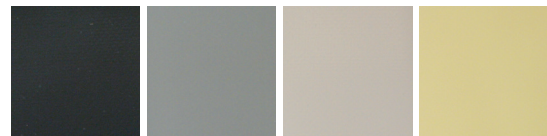

Charcoal   Dark Grey   Grey   Tan

Call Jody on 01424 857743 for a quotation

Covers & Reels

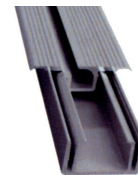
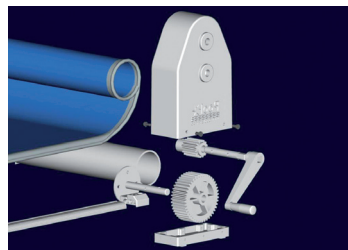
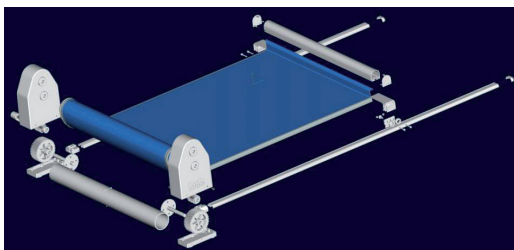

Flush Track



Surface Mount Track

## Plastica Cover Pump

- Automatic start and stop
- Low voltage
- Ballast tank filled to required weight using water
- Simple water sensor probe
- Removable pre-filter



### Plastica Cover Pump

DISCOUNT/ PRODUCT CODE	DESCRIPTION	PRICE EACH
V PCP001	Cover Pump	168.00

# Winter Debris Covers



Made in the UK



- Reduces frost damage
- Minimises discolouration caused by leaves and other debris
- Woven polyethylene
- UV stabilised
- Green/black finish
- Plugs provided for holes when not in use
- 170gsm or 288gsm materials available

Notes: When calculating cover prices add an extra 60cm to each dimension and round up to the nearest square metre.

Strap spacing is normally between 0.91m-1.5m on the width and 1.2m-1.5m along the length.

15% surcharge added for straps at 0.91m spacing. 40% surcharge added for straps at 0.6m spacing.

Covers & Reels

## Deluxe Covers



Made in the UK

- Totally removable in the summer
- P-anchor requires a 6mm drill bit

### Deluxe Debris Covers

DISCOUNT/ PRODUCT CODE	DESCRIPTION	PRICE EACH
I PWD101	Rectangular per sq.m.	17.20
I PWD112	12' x 24' (34m <sup>2</sup> )	584.80
I PWD114	14' x 28' (45m <sup>2</sup> )	774.00
I PWD115	15' x 30' (51m <sup>2</sup> )	877.20
I PWD116	16' x 32' (57m <sup>2</sup> )	980.40
I PWD118	18' x 36' (71m <sup>2</sup> )	1221.80
I PWD120	20' x 40' (86m <sup>2</sup> )	1479.20



### Shaping Charges

DISCOUNT/ PRODUCT CODE	DESCRIPTION	PRICE EACH
I SHWDDS	Shaping surcharge per sq.m.	2.45

### Including 5' Radius Roman End

DISCOUNT/ PRODUCT CODE	DESCRIPTION	PRICE EACH
I PWD112R	12' x 24' (40m <sup>2</sup> )	688.80
I PWD114R	14' x 28' (52m <sup>2</sup> )	895.54
I PWD115R	15' x 30' (58m <sup>2</sup> )	998.88
I PWD116R	16' x 32' (65m <sup>2</sup> )	1119.43
I PWD118R	18' x 36' (80m <sup>2</sup> )	1377.76
I PWD120R	20' x 40' (96m <sup>2</sup> )	1653.31



Note: All sizes stated are pool sizes

## Flush-Fix Debris Covers

MADE TO ORDER

- Brass flush fix anchor with stainless steel spring for tensioning the cover
- Screws back into outer casing when not in use
- Requires a 20mm drill bit

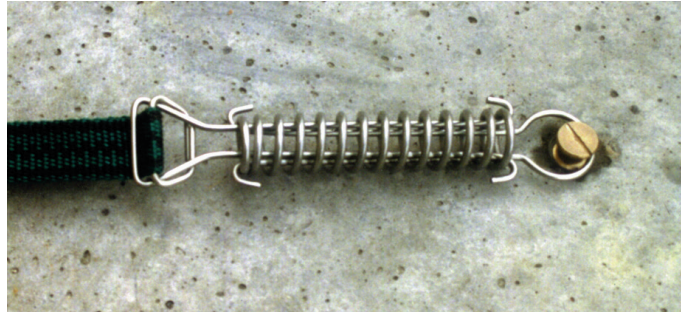

### Flush-Fix Debris Covers

DISCOUNT/ PRODUCT CODE	DESCRIPTION	PRICE EACH
I PWD301	Rectangular per sq.m.	18.00
I PWD401	Criss-Cross per sq.m.	20.20

### Shaping Charges

DISCOUNT/ PRODUCT CODE	DESCRIPTION	PRICE EACH
I SHWDDS	Shaping surcharge per sq.m. for shaped pools	2.45

No Shaping Charges  
for Roman Ends

## Premium Debris Covers

MADE TO ORDER

- Stainless steel D ring and buckle
- Totally removable in the summer season
- Ideal for restricted areas
- Requires a 6mm drill bit



### Debris Covers

DISCOUNT/ PRODUCT CODE	DESCRIPTION	PRICE EACH
I PWD501	Rectangular per sq.m.	16.90
I PWD601	Criss-Cross per sq.m.	19.10

### Shaping Charges

DISCOUNT/ PRODUCT CODE	DESCRIPTION	PRICE EACH
I SHWDDS	Shaping surcharge per sq.m. for shaped pools	2.45

No Shaping Charges  
for Roman Ends

Covers  
& Reels

## Low Profile Decking Covers

MADE TO ORDER

- Low profile brass fittings
- Pin screws flush with fitting when not in use
- Stainless steel spring for tensioning the cover
- Requires a 20mm drill bit

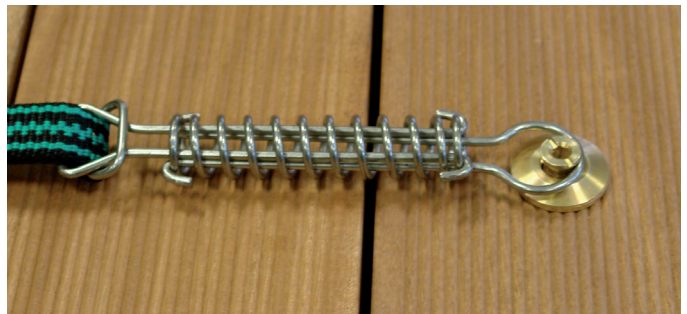

### Low Profile Decking Covers

DISCOUNT/ PRODUCT CODE	DESCRIPTION	PRICE EACH
I PWD901	Rectangular per sq.m.	18.30
I PWD951	Criss-Cross per sq.m.	20.50

### Shaping Charges

DISCOUNT/ PRODUCT CODE	DESCRIPTION	PRICE EACH
I SHWDDS	Shaping surcharge per sq.m. for shaped pools	2.45

No Shaping Charges  
for Roman Ends

# Deluxe Criss Cross Debris Covers



Covers & Reels

## Deluxe Criss Cross

DISCOUNT/ PRODUCT CODE	DESCRIPTION	PRICE EACH
I PWD201	Rectangular per sq.m.	19.40
I PWD253	12' x 24' (34m <sup>2</sup> )	659.60
I PWD255	14' x 28' (45m <sup>2</sup> )	873.00
I PWD257	15' x 30' (51m <sup>2</sup> )	989.40
I PWD259	16' x 32' (57m <sup>2</sup> )	1105.80
I PWD263	18' x 36' (71m <sup>2</sup> )	1377.40
I PWD265	20' x 40' (86m <sup>2</sup> )	1668.40

## Including 5' Radius Roman End

DISCOUNT/ PRODUCT CODE	DESCRIPTION	PRICE EACH
I PWD201	Rectangular per sq.m.	19.40
I PWD253R	12' x 24' (40m <sup>2</sup> )	776.00
I PWD255R	14' x 28' (52m <sup>2</sup> )	1008.80
I PWD257R	15' x 30' (58m <sup>2</sup> )	1125.20
I PWD259R	16' x 32' (65m <sup>2</sup> )	1261.00
I PWD263R	18' x 36' (80m <sup>2</sup> )	1552.00
I PWD265R	20' x 40' (96m <sup>2</sup> )	1862.40

## Shaping Charges

DISCOUNT/ PRODUCT CODE	DESCRIPTION	PRICE EACH
I SHWDDS	Shaping surcharge per sq.m. for shaped pools	2.45

All sizes stated are pool sizes

Note: Ask for our measuring guide booklet and form if you are unsure how to size up your cover.  
A measuring service is available by our surveyor for UK Mainland – see page 6 for further details.

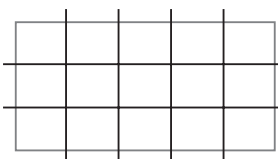

Criss Cross Maximum size:  
50' x 22' (15.24m x 6.71m)  
For larger sizes, contact Customer Services

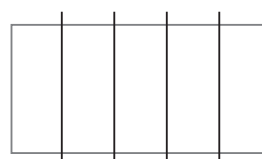

Width Only Maximum size:  
90' x 40' (27.43m x 12.19m)  
For larger sizes, contact Customer Services

## Debris Cover Repair Service

Covers needing repair should be returned during the 'off-season' (before the 1st August). We are unlikely to be able to repair covers between the months of September and November.

The cover should be clean and dry with all springs removed.

Should you choose not to proceed with a repair or order a replacement cover, a fee of £65 will be charged.



# Optional Extras

MADE TO ORDER



Bay Shaping

Optional Extras		
DISCOUNT/ PRODUCT CODE	DESCRIPTION	PRICE EACH
I CUTWDS	Ladder Cut-Outs (per pair)	72.70
I PWD701	Debris Cover per sq.m. with Straps (no fixings)	14.60
I PWD751	Criss-Cross Cover per sq.m. with Straps (no fixings)	16.80
I PWD850	Leaf Seal Skirt with Fixings per linear metre	65.30
I PWD800	0.5m Wide Reinforcing Strip per linear metre	17.00
I EXTWDS	1m Extra Long Straps – surcharge per cover	82.50
I SHWDDS	Shaping surcharge per sq.m.	2.45
I SHWDS	Charge for Shaping Small Bay	49.90
K STA003	500mm Stainless Steel Ground Stake	4.15
K STA004	Deluxe 450mm Aluminium Ground Stake	7.90

Note: there will be a 15% surcharge for straps at 0.91m spacings



Criss Cross Material – PWD751



Leaf Seal Skirt – PWD850



Ladder Cut-Out – CUTWD



Deluxe Ground Stake – STA004



Ground Stake – STA003

Covers & Reels

# Supreme Debris Cover

MADE TO ORDER   
Made in the UK

- Heavy weight 288gsm semi-opaque woven material.
- Cuts light penetration to inhibit algae growth during winter.
- Available with the full range of strap and fitting options.
- Keeps good rainwater draining properties but with increased strength and durability.

Supreme Debris Cover		
DISCOUNT/ PRODUCT CODE	DESCRIPTION	PRICE EACH
I PWD850HD	Supreme Cover Leaf Sealing Skirt per lin.m.	69.80
I PWD101HD	Supreme Deluxe Cover per sq.m.	21.30
I PWD201HD	Supreme Deluxe Criss Cross Cover per sq.m.	23.40
I PWD301HD	Supreme Flush Fix Cover per sq.m.	22.00
I PWD401HD	Supreme Flush Fix Criss Cross Cover per sq.m.	25.00
I PWD501HD	Supreme Premium Cover per sq.m.	20.90
I PWD601HD	Supreme Premium Criss Cross Cover per sq.m.	23.10
I PWD701HD	Supreme Cover with Straps no Fixings	18.70
I PWD751HD	Supreme Criss Cross Cover with Straps no fixings	20.80
I PWD901HD	Low Profile Decking Supreme Cover	22.30
I PWD951HD	Low Profile Decking Criss-Cross Supreme Cover	25.60



## Water Tubes

- Easy method to secure debris cover
- No drilling or permanent installation required

### Water Tubes

DISCOUNT/ PRODUCT CODE	DESCRIPTION	PRICE EACH
I ACC14	Blue 1148mm (3ft 6in)	9.50
I ACC1820	Blue 2286mm (7ft 6in)	18.00
I ACC18DUBL	Black Double 2286mm (7ft 6in)	18.00



## Opaque Debris Cover - Eyelet Version



- Bungee straps spaced every 1m
- Hemmed edge
- Corner wear pads
- 650gsm
- Prevents Trip Hazard

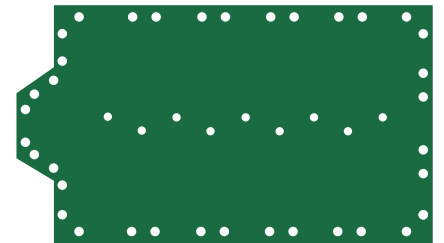
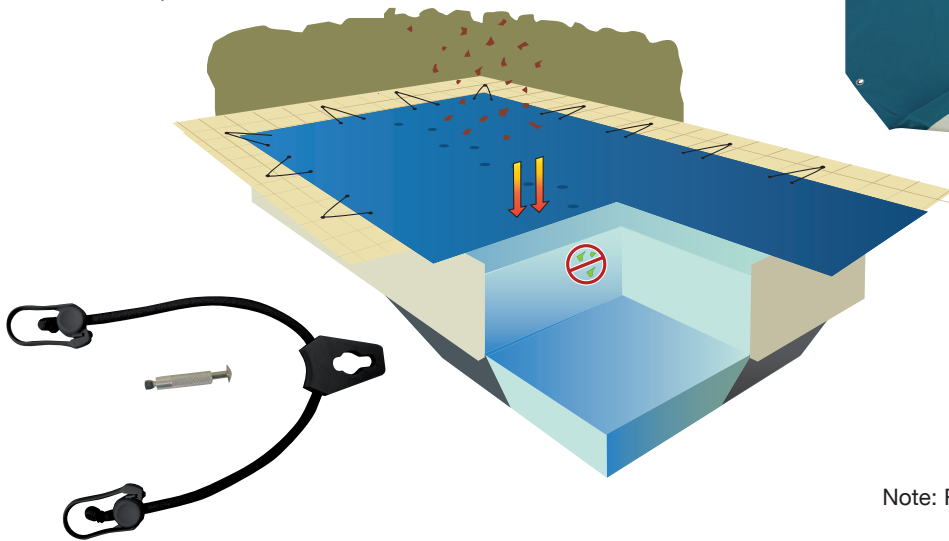
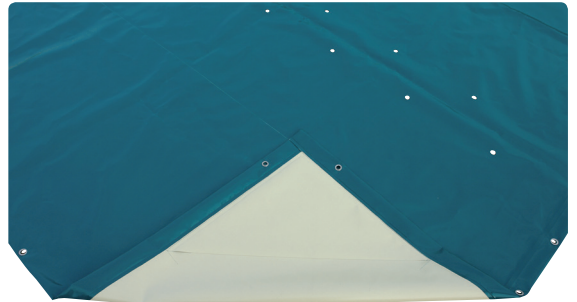

Note: Roman End section will be shaped as shown

### Opaque Debris Covers - Green

DISCOUNT/ PRODUCT CODE	DESCRIPTION	PRICE EACH
I OWDB100G	Rectangular per sq.m. (with eyelets & bungees)	19.00
I OWDB112G	12' x 24' (34m <sup>2</sup> )	646.00
I OWDB114G	14' x 28' (45m <sup>2</sup> )	855.00
I OWDB115G	15' x 30' (51m <sup>2</sup> )	969.00
I OWDB116G	16' x 32' (57m <sup>2</sup> )	1083.00
I OWDB118G	18' x 36' (71m <sup>2</sup> )	1349.00
I OWDB120G	20' x 40' (86m <sup>2</sup> )	1634.00

### Opaque Debris Covers - Green

DISCOUNT/ PRODUCT CODE	DESCRIPTION	PRICE EACH
I OWDB100B	Rectangular per sq.m. (with eyelets & bungees)	19.00
I OWDB112B	12' x 24' (34m <sup>2</sup> )	646.00
I OWDB114B	14' x 28' (45m <sup>2</sup> )	855.00
I OWDB115B	15' x 30' (51m <sup>2</sup> )	969.00
I OWDB116B	16' x 32' (57m <sup>2</sup> )	1083.00
I OWDB118B	18' x 36' (71m <sup>2</sup> )	1349.00
I OWDB120B	20' x 40' (86m <sup>2</sup> )	1634.00

### Shaping Charges

DISCOUNT/ PRODUCT CODE	DESCRIPTION	PRICE EACH
I SHWDDS	Shaping surcharge per sq.m. for shaped pools	2.45

Note: All sizes stated are pool sizes

# Opaque Debris Cover - Strap Version



- Webbing straps spaced every 1.4m
- Hemmed edge
- Corner wear pads
- 650gsm

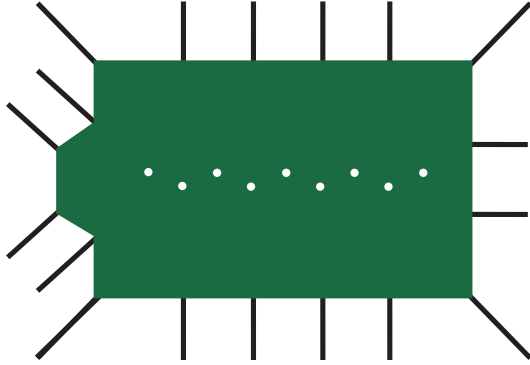

Note: Roman End section will be shaped as shown

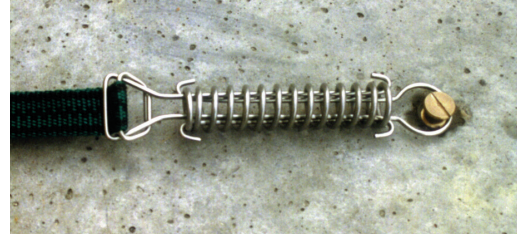

## Opaque Debris Covers - Green

DISCOUNT/ PRODUCT CODE	DESCRIPTION	PRICE EACH
I OWDS101G	Rectangular per sq.m. (with straps)	22.00
I OWDS112G	12' x 24' (34m <sup>2</sup> )	748.00
I OWDS114G	14' x 28' (45m <sup>2</sup> )	990.00
I OWDS115G	15' x 30' (51m <sup>2</sup> )	1122.00
I OWDS116G	16' x 32' (57m <sup>2</sup> )	1254.00
I OWDS118G	18' x 36' (71m <sup>2</sup> )	1562.00
I OWDS120G	20' x 40' (86m <sup>2</sup> )	1892.00

## Opaque Debris Covers - Deluxe Blue

DISCOUNT/ PRODUCT CODE	DESCRIPTION	PRICE EACH
I OWDS101B	Rectangular per sq.m. (with straps)	22.00
I OWDS112B	12' x 24' (34m <sup>2</sup> )	748.00
I OWDS114B	14' x 28' (45m <sup>2</sup> )	990.00
I OWDS115B	15' x 30' (51m <sup>2</sup> )	1122.00
I OWDS116B	16' x 32' (57m <sup>2</sup> )	1254.00
I OWDS118B	18' x 36' (71m <sup>2</sup> )	1562.00
I OWDS120B	20' x 40' (86m <sup>2</sup> )	1892.00

Covers  
& Reels

## Opaque Debris Covers - Flush Fix Green

DISCOUNT/ PRODUCT CODE	DESCRIPTION	PRICE EACH
I OWDS301G	Rectangular per sq.m. (straps)	23.00
I OWDS312G	12' x 24' (34m <sup>2</sup> )	714.00
I OWDS314G	14' x 28' (45m <sup>2</sup> )	945.00
I OWDS315G	15' x 30' (51m <sup>2</sup> )	1071.00
I OWDS316G	16' x 32' (57m <sup>2</sup> )	1197.00
I OWDS318G	18' x 36' (71m <sup>2</sup> )	1491.00
I OWDS320G	20' x 40' (86m <sup>2</sup> )	1978.00

## Opaque Debris Covers - Flush Fix Blue

DISCOUNT/ PRODUCT CODE	DESCRIPTION	PRICE EACH
I OWDS301B	Rectangular per sq.m. (with straps)	23.00
I OWDS312B	12' x 24' (34m <sup>2</sup> )	714.00
I OWDS314B	14' x 28' (45m <sup>2</sup> )	945.00
I OWDS315B	15' x 30' (51m <sup>2</sup> )	1071.00
I OWDS316B	16' x 32' (57m <sup>2</sup> )	1197.00
I OWDS318B	18' x 36' (71m <sup>2</sup> )	1491.00
I OWDS320B	20' x 40' (86m <sup>2</sup> )	1978.00

## Opaque Debris Covers - Premium Green

DISCOUNT/ PRODUCT CODE	DESCRIPTION	PRICE EACH
I OWDS501G	Rectangular per sq.m. (with straps)	21.00
I OWDS512G	12' x 24' (34m <sup>2</sup> )	714.00
I OWDS514G	14' x 28' (45m <sup>2</sup> )	945.00
I OWDS515G	15' x 30' (51m <sup>2</sup> )	1071.00
I OWDS516G	16' x 32' (57m <sup>2</sup> )	1197.00
I OWDS518G	18' x 36' (71m <sup>2</sup> )	1491.00
I OWDS520G	20' x 40' (86m <sup>2</sup> )	1806.00

## Opaque Debris Covers - Premium Blue

DISCOUNT/ PRODUCT CODE	DESCRIPTION	PRICE EACH
I OWDS501B	Rectangular per sq.m. (with straps)	21.00
I OWDS512B	12' x 24' (34m <sup>2</sup> )	714.00
I OWDS514B	14' x 28' (45m <sup>2</sup> )	945.00
I OWDS515B	15' x 30' (51m <sup>2</sup> )	1071.00
I OWDS516B	16' x 32' (57m <sup>2</sup> )	1197.00
I OWDS518B	18' x 36' (71m <sup>2</sup> )	1491.00
I OWDS520B	20' x 40' (86m <sup>2</sup> )	1806.00

Note: All sizes stated are pool sizes

Note: All sizes stated are pool sizes

## Shaping Charges

DISCOUNT/ PRODUCT CODE	DESCRIPTION	PRICE EACH
I SHWDDS	Shaping surcharge per sq.m. for shaped pools	2.45

## Shaping Charges

DISCOUNT/ PRODUCT CODE	DESCRIPTION	PRICE EACH
I SHWDDS	Shaping surcharge per sq.m. for shaped pools	2.45

# Non-standard Size Winter Debris Covers Pricing Formula

Find the diagram or description that corresponds with your pool shape.  
 Follow the calculation method to find the Chargeable Area to the nearest sq.m.  
 Multiply the Chargeable Area by the cover price, then add any necessary shaping charges.  
 Debris covers are calculated as pool size plus 0.6m (0.3m or 1' overlap to every side)

COVER SHAPE	CALCULATION	COVER SHAPE	CALCULATION
ANY SHAPE OF COVER with LADDER CUT-OUTS	<b>Cover Price =</b> Cover Area (CA) x Price per m <sup>2</sup> PLUS 1 x Cut-Out Charge <b>CUTWD</b> per ladder		<b>CIRCULAR</b>  <b>CA = W x W</b> Cover Price = CA x (Price per m <sup>2</sup> + <b>SHWDD</b> Shaping surcharge per m <sup>2</sup> )
	<b>RECTANGULAR</b>  <b>CA = L x W</b> Cover Price = CA x Price per m <sup>2</sup>		<b>OVAL</b>  <b>CA = L x W</b> Cover Price = CA x (Price per m <sup>2</sup> + <b>SHWDD</b> Shaping surcharge per m <sup>2</sup> )
	<b>ROMAN END</b>  <b>CA = L x W</b> Cover Price = CA x Price per m <sup>2</sup>		<b>FREEFORM/KIDNEY</b>  <b>CA = L x W</b> Cover Price = CA x (Price per m <sup>2</sup> + <b>SHWDD</b> Shaping surcharge per m <sup>2</sup> )
	<b>DOUBLE ROMAN END</b>  <b>CA = L x W</b> Cover Price = CA x Price per m <sup>2</sup>		<b>SHAPED OVAL/PEAR</b>  <b>CA = L x W</b> Cover Price = CA x (Price per m <sup>2</sup> + <b>SHWDD</b> Shaping surcharge per m <sup>2</sup> )
	<b>WALK IN STAIRS/BAYS</b>  <b>CA = L x W + (L2 x W2)</b> Cover Price = CA x Price per m <sup>2</sup> Add 1 x <b>SHWD</b> Charge for Bay Shaping		<b>DOG LEG/LAZY 'L'</b>  <b>CA = L x W + (L2 x W2)</b> Cover Price = CA x (Price per m <sup>2</sup> + <b>SHWDD</b> Shaping surcharge per m <sup>2</sup> )

Covers & Reels



Contact us now to order your **Lighting and Pool Flow requirements**

01424 857857

01424 875858

[info@plasticapools.net](mailto:info@plasticapools.net)

[www.plasticapools.net](http://www.plasticapools.net)

Find us on





## Deluxe Above Ground Pool Covers



- New made to measure Above Ground Pool covers
- Choice of two materials as below
- Mesh Weave material that allows rainwater to pass through
- Deluxe Tarpaulin material that blocks all debris and light
- Use during the Summer or Winter
- Comes complete with elasticated tie-downs and wall clips



### Deluxe Above Ground Pool Covers

DISCOUNT/ PRODUCT CODE	DESCRIPTION	PRICE EACH
L PWD100	Mesh Weave Above Ground Debris per m <sup>2</sup>	12.45
L PWD200	Deluxe Tarpaulin Above Ground Debris per m <sup>2</sup>	15.60

## Premium Wooden Pool Winter Covers



- Winter covers for Plastica Premium Wooden Pools

### Wooden Pool Winter Covers

DISCOUNT/ PRODUCT CODE	DESCRIPTION	PRICE EACH
L PWA115	Cover for 4m Knightsbridge	78.00
L PWA118	Cover for 5m Mayfair	103.00
L PWA120	Cover for 6m Kensington	131.00
L PWA225	Cover for 5.5m x 3.6m Belgravia	127.00
L PWA229	Cover for 6.5m x 3.6m Bayswater	132.00
L PWA233	Cover for 8.1m x 4.6m Westminster	180.00
L PWA216	Cover for Exercise Pool	59.00



Covers  
& Reels

## Intex Winter Covers



### Easy Set

DISCOUNT/ PRODUCT CODE	DESCRIPTION	PRICE EACH
L 28020	8'	10.00
L 28022/E	12'	17.60
L 28023/E	15'	23.80



### Metal Frame

DISCOUNT/ PRODUCT CODE	DESCRIPTION	PRICE EACH
L 28031	12'	20.20
L 28032	15'	27.80

## Above Ground Winter Covers

MADE  
TO  
ORDER

- Woven polyethylene
- Comes complete with Winch and Cable

### Oval

DISCOUNT/ PRODUCT CODE	DESCRIPTION	PRICE EACH
L PWA214	8' x 12'	42.00
L PWA215	10' x 15'	59.00
L PWA216	10' x 16'	59.00
L PWA224	12' x 24'	103.00
L PWA225	15' x 21'	127.00
L PWA229	16' x 28'	132.00
L PWA230	15' x 30'	142.50
L PWA232	16' x 32'	154.00
L PWA233	18' x 33'	180.00



### Diameter

DISCOUNT/ PRODUCT CODE	DESCRIPTION	PRICE EACH
L PWA112	12'	61.00
L PWA115	15'	78.00
L PWA116	16'	82.00
L PWA118	18'	103.00
L PWA120	21'	131.00
L PWA124	24'	155.00

### Winch & Cable

DISCOUNT/ PRODUCT CODE	DESCRIPTION	PRICE EACH
K ACW1001	Aluminium Cable Winch	8.00
K VCCC100	Vinyl Coated Cover Cable 100ft	22.00

## Plastica Cover Pump

- Automatic start and stop
- Low voltage
- Ballast tank filled to required weight using water
- Simple water sensor probe
- Removable pre-filter



### Plastica Cover Pump

DISCOUNT/ PRODUCT CODE	DESCRIPTION	PRICE EACH
V PCP001	Cover Pump	168.00

## Air Pillow

- Designed to fit under winter cover to eradicate water build up on the cover surface

### Air Pillow

DISCOUNT/ PRODUCT CODE	DESCRIPTION	PRICE EACH
L PWA300	1.2m x 1.52m inflated	25.00

(Two pillows are recommended for ovals over 12' x 20')

