

Above Ground



Above
Ground

bespoke
POOL SALES



Bespoke Sales LTD.
sales@bespokepoolsales.co.uk
(UK) Tel: 1 001268 710425

Premium Wooden Pool Kits



We appreciate that customers require the freedom to specify exactly what they need with their wooden pool. Now each pool can be customised to suit the customers needs, making it easier to up-spec to a top of the range piece of equipment that can be enjoyed for years to come.

We have listed what we regard as essential components and optional extras. On top of this, individual product discounts apply, which is great news for our customers. We can still offer wooden pools we have listed in previous years or bespoke wooden pools - just call us for more information.

For the full range go to www.plasticpools.net

It is important to read through each option to see what comes with each kit, as most of the equipment has been separated.

FREE
delivery
England and
Wales
mainland

All our Structure Kits contain the following:



A robust timber structure - Using 44mm pressure treated redwood timber, which is all selected from renewable sources. Included are all necessary timber supports and fixings, along with an external wooden ladder and internal Stainless Steel ladder.

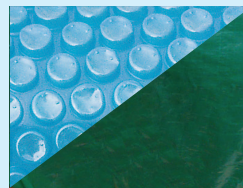

Summer Solar Cover and Winter Debris Cover - (Standard Debris Cover unavailable for Chelsea)

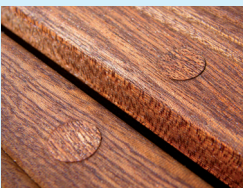

An exotic two piece hardwood top shelving - Featuring our own reversible bespoke profile, designed to make fixing as neat as possible using our plug and pellet hidden fixings.

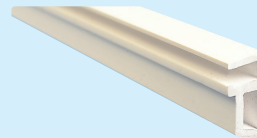

Side mount Liner lock - Ready to receive your choice of liner.



Metal braces - For pools that require metal braces these are included in the structure kit. On premium pools, these are cleverly boxed in to keep the wonderful timber aesthetics.

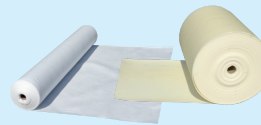

Foam and Felt underlay - Giving our tailored liners a beautiful soft touch as well as added protection, complete with spray adhesive and underlay tape.

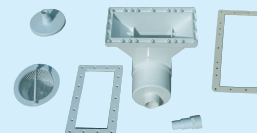

White goods kit - Wide mouth skimmer, return and low level suction where appropriate.

Above
Ground



Filtration Kit - We recommend our super reliable 0.75hp iflo pump and filter package, as well as Essential Plumbing Kit to complete your installation. (Extra fittings available if plant situated away from pool)

Upgraded Endurance 1hp Pump plus 24" filter & Essential plumbing kit including 2 main drains for the Chelsea wooden pool.

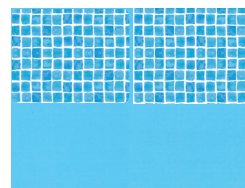

Liner options - Our liners are now priced as separate options to give you more choice and make quotations easier. Simply select the style and pattern required and add to your order. See pages 48 & 49 for liner options.



Maintenance Kit contains - Backwash hose, chemical starter kit, vac head, vac hose, telescopic pole, leaf net and brush - everything you need to keep your pool beautifully clean.

Optional extras



Heating - If you are looking to heat your wooden pool, we have specified our recommended heating methods for you to choose from.



Lighting - After a hugely successful season with the Mini Chroma Lights we have produced a complete Lighting Package for wooden pools. Available in brilliant white or full remote-control colour-change setup.

*Please note we strongly recommend equipment we have selected for each wooden pool. If you wish to upgrade please speak to one of our advisors.

Wooden Pool Filtration Enclosures



Made in the UK

- Securely house your pool filtration, heating etc
- Full height of pool
- Designed to be fitted to skimmer wall
- Double front doors
- Easily removable top for complete access
- Top trap for easy skimmer maintenance

Wooden Pool Filtration Enclosure

DISCOUNT/ PRODUCT CODE	DESCRIPTION	PRICE EACH
L2 WFE100	Standard Wooden Pool Plant Enclosure	350.00



Backboard shown for illustration purposes only

Wooden Pool Pipework Kit



Made in the UK

- Pipework Kit for addition of electric heaters or other plant

Wooden Pool Pipework Kit

DISCOUNT/ PRODUCT CODE	DESCRIPTION	PRICE EACH
L2 WPU200K	Pipework Kit	60.00

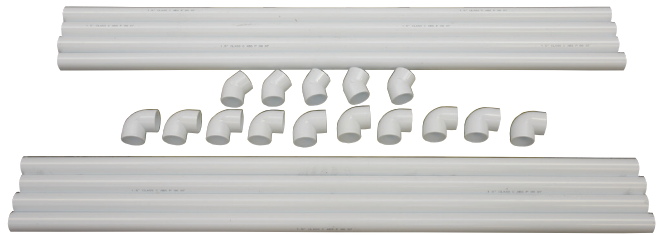

Above
Ground

Wooden Pool Brace Kits



Made in the UK

Braces

DISCOUNT/ PRODUCT CODE	DESCRIPTION	PRICE EACH
L2 WPB011K	Exercise Pool, contains 2 braces	470.00
L2 WPB012K	Belgravia, contains 2 braces	470.00
L2 WPB013K	Bayswater, contains 4 braces	825.00
L2 WPB013K	Large Stretched Eco, contains 4 braces	825.00
L2 WPB014K	Westminster, contains 6 braces	1175.00
L2 WPB016K	Chelsea, contains 12 braces	2275.00



Richmond



Volume 8970 Litres
1973 galls

FREE
delivery
England and
Wales
mainland



The Richmond Wooden Pool is our most compact pool enabling you to make the most of the corner of a smaller garden

Standard Pool Package Example List Price £4895.00*

Contains Structure Kit, Filtration Kit, Plain Liner option and Maintenance Kit

Richmond*

DISCOUNT/ PRODUCT CODE	DESCRIPTION	PRICE EACH
L2 WSK008	⚙️ ▲ Structure Kit*	3675.00

Filtration Kit*

DISCOUNT/ PRODUCT CODE	DESCRIPTION	PRICE EACH
L2 WFK001	⚙️ ▲ iFlo Filter Pump Pack c/w Essential Plumbing*	455.00
L2 WPU200K	⚙️ ▲ Wooden Pool Extra Pipework Kit	60.00

Liner Options*

DISCOUNT/ PRODUCT CODE	DESCRIPTION	PRICE EACH
A PLI4211	⚙️ ▲ Plain Liner 0.75mm*	637.20
A PLI421	⚙️ ▲ Plain Liner with Tileband 0.75mm	715.50
A PLI4212	⚙️ ▲ All-over patterned Liner 0.75mm	880.20

Maintenance Kit*

DISCOUNT/ PRODUCT CODE	DESCRIPTION	PRICE EACH
M WMK001	⚙️ ▲ Maintenance Pack & Starter Kit*	128.65

Light Package Options*

DISCOUNT/ PRODUCT CODE	DESCRIPTION	PRICE EACH
K WMK001	⚙️ ▲ Mini Chroma White LED Kit contains 1 white light c/w 100W Transformer & Deck Box Kit	265.75
K WMK001	⚙️ ▲ Mini Chroma RGB LED Kit c/w Remote contains 1 RGBW light c/w sync panel 100W Transformer & Deck Box Kit	460.75

Heating Options*

DISCOUNT/ PRODUCT CODE	DESCRIPTION	PRICE EACH
K HSE056	⚙️ ▲ HeatSeeker 5.6kW	1224.00
H 8T86	⚙️ ▲ Elecro 6kW	560.00

Filtration Enclosure

DISCOUNT/ PRODUCT CODE	DESCRIPTION	PRICE EACH
L2 WFE100	⚙️ Standard Wooden Pool Plant Enclosure	350.00

Knightsbridge



Volume 11500 Litres
2500 galls

FREE
delivery
England and
Wales
mainland



The Knightsbridge Wooden Pool is a compact 4m internally octagonal structure with all the high-end quality filtration equipment usually associated with in-ground swimming pools.

Standard Pool Package Example List Price £5140.00*

Contains Structure Kit, Filtration Kit, Plain Liner option and Maintenance Kit

Knightsbridge*

DISCOUNT/ PRODUCT CODE	DESCRIPTION	PRICE EACH
L2 WSK001	🔴🟢 Structure Kit*	3825.00

Filtration Kit*

DISCOUNT/ PRODUCT CODE	DESCRIPTION	PRICE EACH
L2 WFK001	🔴🟢 iFlo Filter Pump Pack c/w Essential Plumbing*	455.00
L2 WPU200K	🔴🟢 Wooden Pool Extra Pipework Kit	60.00

Liner Options*

DISCOUNT/ PRODUCT CODE	DESCRIPTION	PRICE EACH
A PLI4011	🔴🟢 Plain Liner 0.75mm*	731.60
A PLI401	🔴🟢 Plain Liner with Tileband 0.75mm	821.50
A PLI4012	🔴🟢 All-over patterned Liner 0.75mm	1010.60

Maintenance Kit*

DISCOUNT/ PRODUCT CODE	DESCRIPTION	PRICE EACH
M WMK001	🔴🟢 Maintenance Pack & Starter Kit*	128.65

Light Package Options*

DISCOUNT/ PRODUCT CODE	DESCRIPTION	PRICE EACH
K WMK001	🔴🟢 Mini Chroma White LED Kit contains 1 white light c/w 100W Transformer & Deck Box Kit	265.75
K WMK001	🔴🟢 Mini Chroma RGB LED Kit c/w Remote contains 1 RGBW light c/w sync panel 100W Transformer & Deck Box Kit	460.75

Heating Options*

DISCOUNT/ PRODUCT CODE	DESCRIPTION	PRICE EACH
K HSE056	🔴🟢 HeatSeeker 5.6kW	1224.00
H 8T86	🔴🟢 Electro 6kW	560.00

Filtration Enclosure

DISCOUNT/ PRODUCT CODE	DESCRIPTION	PRICE EACH
L2 WFE100	🔴🟢 Standard Wooden Pool Plant Enclosure	350.00

Above
Ground

Mayfair



Volume 22450 Litres
4938 galls

FREE
delivery
England and
Wales
mainland



The Mayfair Wooden Pool is a 5m internally octagonal structure with all the high-end quality filtration equipment usually associated with in-ground swimming pools.

Standard Pool Package Example List Price £6305.65*

Contains Structure Kit, Filtration Kit, Plain Liner option and Maintenance Kit

Mayfair*

DISCOUNT/ PRODUCT CODE	DESCRIPTION	PRICE EACH
L2 WSK009	⚙️ ▲ Structure Kit*	4660.00

Filtration Kit*

DISCOUNT/ PRODUCT CODE	DESCRIPTION	PRICE EACH
L2 WFK001	⚙️ ▲ iFlo Filter Pump Pack c/w Essential Plumbing*	455.00
L2 WPU200K	⚙️ ▲ Wooden Pool Extra Pipework Kit	60.00

Liner Options*

DISCOUNT/ PRODUCT CODE	DESCRIPTION	PRICE EACH
A PLI4021	⚙️ ▲ Plain Liner 0.75mm*	1062.00
A PLI402	⚙️ ▲ Plain Liner with Tileband 0.75mm	1192.50
A PLI4022	⚙️ ▲ All-over patterned Liner 0.75mm	1467.00

Maintenance Kit*

DISCOUNT/ PRODUCT CODE	DESCRIPTION	PRICE EACH
M WMK001	⚙️ ▲ Maintenance Pack & Starter Kit*	128.65

Light Package Options*

DISCOUNT/ PRODUCT CODE	DESCRIPTION	PRICE EACH
K WMK001	⚙️ ▲ Mini Chroma White LED Kit contains 1 white light c/w 100W Transformer & Deck Box Kit	265.75
K WMK001	⚙️ ▲ Mini Chroma RGB LED Kit c/w Remote contains 1 RGBW light c/w sync panel 100W Transformer & Deck Box Kit	460.75

Heating Options*

DISCOUNT/ PRODUCT CODE	DESCRIPTION	PRICE EACH
K HSE095	⚙️ ▲ HeatSeeker 9.5kW	1612.00
H 8T89	⚙️ ▲ Electro 9kW	603.00

Filtration Enclosure

DISCOUNT/ PRODUCT CODE	DESCRIPTION	PRICE EACH
L2 WFE100	⚙️ Standard Wooden Pool Plant Enclosure	350.00

Above
Ground

Hampstead

HEAVY
ITEM



Made in the UK

Volume 25200 Litres
5550 galls

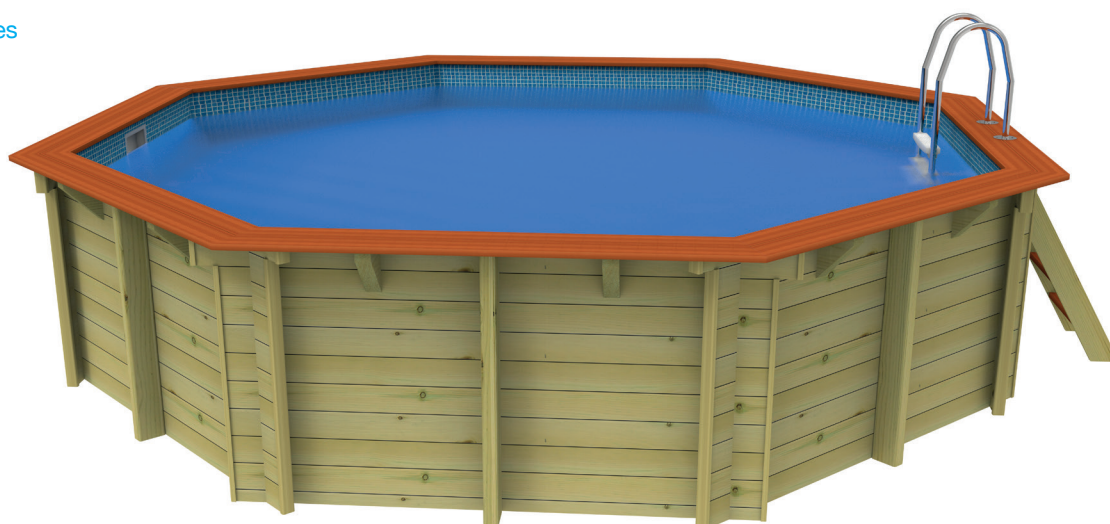

FREE
delivery
England and
Wales
mainland

The Hampstead Wooden Pool is a great sized pool for most gardens, which measures 5.5m internally.

Standard Pool Package Example List Price £6535.00*

Contains Structure Kit, Filtration Kit, Plain Liner option and Maintenance Kit

Hampstead*

DISCOUNT/ PRODUCT CODE	DESCRIPTION	PRICE EACH
L2 WSK002	🔧📦 Structure Kit*	4795.00

Filtration Kit*

DISCOUNT/ PRODUCT CODE	DESCRIPTION	PRICE EACH
L2 WFK001	🔧📦 iFlo Filter Pump Pack c/w Essential Plumbing*	455.00
L2 WPU200K	🔧📦 Wooden Pool Extra Pipework Kit	60.00

Liner Options*

DISCOUNT/ PRODUCT CODE	DESCRIPTION	PRICE EACH
A PLI1111	🔧📦 Plain Liner 0.75mm*	1156.40
A PLI111	🔧📦 Plain Liner with Tileband 0.75mm	1298.50
A PLI1112	🔧📦 All-over Patterned Liner 0.75mm	1597.40

Maintenance Kit*

DISCOUNT/ PRODUCT CODE	DESCRIPTION	PRICE EACH
M WMK001	🔧📦 Maintenance Pack & Starter Kit*	128.65

Light Package Options*

DISCOUNT/ PRODUCT CODE	DESCRIPTION	PRICE EACH
K WMK001	🔧📦 Mini Chroma White LED Kit contains 1 white light c/w 100W Transformer & Deck Box Kit	265.75
K WMK001	🔧📦 Mini Chroma RGB LED Kit c/w Remote contains 1 RGBW light c/w sync panel 100W Transformer & Deck Box Kit	460.75

Heating Options*

DISCOUNT/ PRODUCT CODE	DESCRIPTION	PRICE EACH
K HSE095	🔧📦 HeatSeeker 9.5kW	1612.00
H 8T8A	🔧📦 Electro 12kW	617.00

Filtration Enclosure

DISCOUNT/ PRODUCT CODE	DESCRIPTION	PRICE EACH
L2 WFE100	🔧📦 Standard Wooden Pool Plant Enclosure	350.00

Above
Ground

Belgravia



Volume 21000 Litres
4600 galls

FREE
delivery
England and
Wales
mainland



The Belgravia Wooden Pool is a 3.694m x 5.564m internally stretched octagonal structure, perfect for all sizes of garden and great for the more serious swimmer.

Standard Pool Package Example List Price £6797.00*

Contains Structure Kit, Filtration Kit, Plain Liner option and Maintenance Kit

Belgravia with Braces Kit*

DISCOUNT/ PRODUCT CODE	DESCRIPTION	PRICE EACH
L2 WSK003	⚙️ ▲ Structure Kit including Brace Kit, contains 2 braces*	5175.00

Filtration Kit*

DISCOUNT/ PRODUCT CODE	DESCRIPTION	PRICE EACH
L2 WFK001	⚙️ ▲ iFlo Filter Pump Pack c/w Essential Plumbing*	455.00
L2 WPU200K	⚙️ ▲ Wooden Pool Extra Pipework Kit	60.00

Liner Options*

DISCOUNT/ PRODUCT CODE	DESCRIPTION	PRICE EACH
A PLI4042	⚙️ ▲ Plain Liner 0.75mm*	1038.40
A PLI404	⚙️ ▲ Plain Liner with Tileband 0.75mm	1166.00
A PLI4012	⚙️ ▲ All-over Patterned Liner 0.75mm	1434.40

Maintenance Kit*

DISCOUNT/ PRODUCT CODE	DESCRIPTION	PRICE EACH
M WMK001	⚙️ ▲ Maintenance Pack & Starter Kit*	128.65

Light Package Options*

DISCOUNT/ PRODUCT CODE	DESCRIPTION	PRICE EACH
K WMK001	⚙️ ▲ Mini Chroma White LED Kit contains 1 white light c/w 100W Transformer & Deck Box Kit	265.75
K WMK001	⚙️ ▲ Mini Chroma RGB LED Kit c/w Remote contains 1 RGBW light c/w sync panel 100W Transformer & Deck Box Kit	460.75

Heating Options*

DISCOUNT/ PRODUCT CODE	DESCRIPTION	PRICE EACH
K HSE095	⚙️ ▲ HeatSeeker 9.5kW	1612.00
H 8T89	⚙️ ▲ Electro 9kW	603.00

Filtration Enclosure

DISCOUNT/ PRODUCT CODE	DESCRIPTION	PRICE EACH
L2 WFE100	⚙️ Standard Wooden Pool Plant Enclosure	350.00

Bayswater



Volume 25000 Litres
5500 galls



FREE
delivery
England and
Wales
mainland

The Bayswater Wooden Pool is a 3.694m x 6.564m internally stretched octagonal structure. It is the bigger brother of the Belgravia, but with an extra 1m length making an incredible difference.

Standard Pool Package Example List Price £7837.00*

Contains Structure Kit, Filtration Kit, Plain Liner option and Maintenance Kit

Bayswater with Braces Kit*

DISCOUNT/ PRODUCT CODE	DESCRIPTION	PRICE EACH
L2 WSK004	⚙️ ▲ Structure Kit with Brace Kit, contains 4 braces*	6050.00

Filtration Kit*

DISCOUNT/ PRODUCT CODE	DESCRIPTION	PRICE EACH
L2 WFK001	⚙️ ▲ iFlo Filter Pump Pack c/w Essential Plumbing*	455.00
L2 WPU200K	⚙️ ▲ Wooden Pool Extra Pipework Kit	60.00

Liner Options*

DISCOUNT/ PRODUCT CODE	DESCRIPTION	PRICE EACH
A PLI4051	⚙️ ▲ Plain Liner 0.75mm*	1203.60
A PLI405	⚙️ ▲ Plain Liner with Tileband 0.75mm	1351.50
A PLI4052	⚙️ ▲ All-over Patterned Liner 0.75mm	1662.60

Maintenance Kit*

DISCOUNT/ PRODUCT CODE	DESCRIPTION	PRICE EACH
M WMK001	⚙️ ▲ Maintenance Pack & Starter Kit*	128.65

Light Package Options*

DISCOUNT/ PRODUCT CODE	DESCRIPTION	PRICE EACH
K MCLED02K	⚙️ ▲ Mini Chroma White LED Kit contains 2 white lights c/w 100W Transformer & Deck Box Kit	450.50
K MCRGB02K	⚙️ ▲ Mini Chroma RGB LED Kit c/w Remote contains 2 RGBW lights c/w sync panel 100W Transformer & Deck Box Kit	720.50

Heating Options*

DISCOUNT/ PRODUCT CODE	DESCRIPTION	PRICE EACH
K HSE095	⚙️ ▲ HeatSeeker 9.5kW	1612.00
H 8T8A	⚙️ ▲ Elecro 12kW	617.00

Filtration Enclosure

DISCOUNT/ PRODUCT CODE	DESCRIPTION	PRICE EACH
L2 WFE100	⚙️ Standard Wooden Pool Plant Enclosure	350.00

Above
Ground

Westminster



Volume 39200 Litres
8600 galls



FREE
delivery
England and
Wales
mainland

The Westminster Wooden Pool is a huge 4.611m x 8.201m internally stretched octagonal structure. Designed for the larger garden. Perfect for the larger family as well as keen swimmers.

Standard Pool Package Example List Price £9354.00*

Contains Structure Kit, Filtration Kit, Plain Liner option and Maintenance Kit

Westminster with Braces Kit*

DISCOUNT/ PRODUCT CODE	DESCRIPTION	PRICE EACH
L2 WSK005	⚙️ ▲ Structure Kit contains 6 braces*	7095.00

Filtration Kit*

DISCOUNT/ PRODUCT CODE	DESCRIPTION	PRICE EACH
L2 WFK001	⚙️ ▲ iFlo Filter Pump Pack c/w Essential Plumbing*	455.00
L2 WPU200K	⚙️ ▲ Wooden Pool Extra Pipework Kit	60.00

Liner Options*

DISCOUNT/ PRODUCT CODE	DESCRIPTION	PRICE EACH
A PLI4171	⚙️ ▲ Plain Liner 0.75mm*	1675.60
A PLI417	⚙️ ▲ Plain Liner with Tileband 0.75mm	1881.50
A PLI4172	⚙️ ▲ All-over Patterned Liner 0.75mm	2314.60

Maintenance Kit*

DISCOUNT/ PRODUCT CODE	DESCRIPTION	PRICE EACH
M WMK001	⚙️ ▲ Maintenance Pack & Starter Kit*	128.65

Light Package Options*

DISCOUNT/ PRODUCT CODE	DESCRIPTION	PRICE EACH
K MCLED02K	⚙️ ▲ Mini Chroma White LED Kit contains 2 white lights c/w 100W Transformer & Deck Box Kit	450.50
K MCRGB02K	⚙️ ▲ Mini Chroma RGB LED Kit c/w Remote contains 2 RGBW lights c/w sync panel 100W Transformer & Deck Box Kit	720.50

Heating Options*

DISCOUNT/ PRODUCT CODE	DESCRIPTION	PRICE EACH
K HSE125	⚙️ ▲ HeatSeeker 12.5kW	1858.00
H 8T8C	⚙️ ▲ Electro 18kW	736.00

Filtration Enclosure

DISCOUNT/ PRODUCT CODE	DESCRIPTION	PRICE EACH
L2 WFE100	⚙️ Standard Wooden Pool Plant Enclosure	350.00

Chelsea

HEAVY
ITEM



Made in the UK

Volume 57400 Litres
12600 galls



The Chelsea Pool is a 5m x 10m internally rectangular pool, our largest wooden swimming pool and the flagship of our Premium range. Great above ground or submerged.

Standard Pool Package Example List Price £14255.00*

Contains Structure Kit, Filtration Kit, Plain Liner option and Maintenance Kit

Chelsea with Braces Kit*

DISCOUNT/ PRODUCT CODE	DESCRIPTION	PRICE EACH
L2 WSK006	Structure Kit contains 12 braces* (standard debris cover not included)	10595.00

Filtration Kit*

DISCOUNT/ PRODUCT CODE	DESCRIPTION	PRICE EACH
L2 WFK002	Endurance Filter Pump Pack c/w Essential Plumbing*	1419.00
L2 WPU200K	Wooden Pool Extra Pipework Kit	60.00

Liner Options*

DISCOUNT/ PRODUCT CODE	DESCRIPTION	PRICE EACH
A PLI1101	Plain Liner 0.75mm*	2100.40
A PLI110	Plain Liner with Tileband 0.75mm	2358.50
A PLI1102	All-over Patterned Liner 0.75mm	2901.40

Maintenance Kit*

DISCOUNT/ PRODUCT CODE	DESCRIPTION	PRICE EACH
M WMK002	Maintenance Pack & Starter Kit*	140.65

Light Package Options*

DISCOUNT/ PRODUCT CODE	DESCRIPTION	PRICE EACH
K MCLED03K	Mini Chroma White LED Kit contains 3 white lights c/w 100W Transformer & 3 Deck Box Kits	635.25
K MCRGB03K	Mini Chroma RGB LED Kit c/w Remote contains 3 RGBW lights c/w sync panel 100W Transformer & 3 Deck Box Kits	980.25

Heating Options*

DISCOUNT/ PRODUCT CODE	DESCRIPTION	PRICE EACH
K HSE170	HeatSeeker 17kW	2940.00

Filtration Enclosure

DISCOUNT/ PRODUCT CODE	DESCRIPTION	PRICE EACH
L2 WFE100	Standard Wooden Pool Plant Enclosure	350.00

Above
Ground

Exercise Pool



Volume 8150 Litres
1795 galls



FREE
delivery
England and
Wales
mainland

The Exercise Pool is a 2.426m x 3.916m internally and comes with a choice of 3 over the wall Counter Current Systems to accommodate most users.

Standard Pool Package Example List Price £7946.00 with Badu Perla 1.6kW Counter Current System*

Contains Structure Kit, Filtration Kit, Plain Liner option, Maintenance Kit and Badu Perla Counter Current System

Exercise Pool*

DISCOUNT/ PRODUCT CODE	DESCRIPTION	PRICE EACH
L2 WSK007	Structure Kit with Brace Kit, contains 2 braces*	4395.00
K 3BTE0354	Aquajet 50 1.1kW Counter Current System	1240.00
K AQUA100	Aquajet 100 1.1kW Counter Current System	2200.00
K BAD015	Badu Perla 1.6kW Counter Current System	3017.00
K BAD006	Badu Riva 2.2kW Counter Current System	2200.00

More information on Counter Current Systems on pages 42 - 43 and 196

Filtration Kit*

DISCOUNT/ PRODUCT CODE	DESCRIPTION	PRICE EACH
L2 WFK001	iFlo Filter Pump Pack c/w Essential Plumbing*	455.00
L2 WPU200K	Wooden Pool Extra Pipework Kit	60.00

Liner Options*

DISCOUNT/ PRODUCT CODE	DESCRIPTION	PRICE EACH
A PLI4181	Plain Liner 0.75mm*	566.40
A PLI418	Plain Liner with Tileband 0.75mm	636.00
A PLI4182	All-over Patterned Liner 0.75mm	782.40
A PLI418R	2.8 metre Race Line welded to centre of liner floor (optional extra)	165.00

Maintenance Kit*

DISCOUNT/ PRODUCT CODE	DESCRIPTION	PRICE EACH
M WMK001	Maintenance Pack & Starter Kit*	128.65

Light Package Options*

DISCOUNT/ PRODUCT CODE	DESCRIPTION	PRICE EACH
K MCLED01K	Mini Chroma White LED Kit contains 1 white light c/w 100W Transformer & Deck Box Kit	265.75
K MCRGB01K	Mini Chroma RGB LED Kit c/w Remote contains 1 RGBW light c/w sync panel 100W Transformer & Deck Box Kit	460.75

Heating Options*

DISCOUNT/ PRODUCT CODE	DESCRIPTION	PRICE EACH
K HSE056	HeatSeeker 5.6kW	1224.00
H 8T89	Electro 9kW	603.00

Filtration Enclosure

DISCOUNT/ PRODUCT CODE	DESCRIPTION	PRICE EACH
L2 WFE100	Standard Wooden Pool Plant Enclosure	350.00

X-Stream Exercise Pool

HEAVY
ITEM



Made in the UK

FREE
delivery
England and
Wales
mainland

Volume 8150 Litres
1795 galls



X-Stream Counter Current Unit

The X-Stream Pool is a 2.426m x 3.916m pool. This comes with a choice of two X-Stream through the wall Counter Current Systems.

Complete Exercise Pool package with X-Stream Duo System £9975.00

Contains Structure Kit, Filtration Kit, Plain Liner, Maintenance Kit, X-Stream Duo Counter Current Unit, Control Unit, Complete Plumbing Kit, 2 x Wiper Pumps.

X-Stream Exercise Pool*

DISCOUNT/ PRODUCT CODE	DESCRIPTION	PRICE EACH
L2 WSK0071	Structure Kit with Brace Kit, contains 2 braces, plus single pre-cut out for X-Stream Counter Current Unit*	4745.00
K XST001K	X-Stream Single Kit c/w Control Unit, complete Plumbing Kit, 1 x Nadorsel Counter Current Pump	3482.00
K XST002K	X-Stream Duo Kit c/w Control Unit, complete Plumbing Kit, 2 x Wiper Counter Current Pumps	4080.00

More information on Counter Current Systems on pages 42 - 43 and 196

Filtration Kit*

DISCOUNT/ PRODUCT CODE	DESCRIPTION	PRICE EACH
L2 WFK001	iFlo Filter Pump Pack c/w Essential Plumbing*	455.00
L2 WPU200K	Wooden Pool Extra Pipework Kit	60.00

Liner Options*

DISCOUNT/ PRODUCT CODE	DESCRIPTION	PRICE EACH
A PLI4181	Plain Liner 0.75mm*	566.40
A PLI418	Plain Liner with Tileband 0.75mm	636.00
A PLI4182	All-over Patterned Liner 0.75mm	782.40
A PLI418R	2.8 metre Race Line welded to centre of liner floor (optional extra)	165.00

Maintenance Kit*

DISCOUNT/ PRODUCT CODE	DESCRIPTION	PRICE EACH
M WMK001	Maintenance Pack & Starter Kit*	128.65

Light Package Options

DISCOUNT/ PRODUCT CODE	DESCRIPTION	PRICE EACH
K MCLED01K	Mini Chroma White LED Kit contains 1 white light c/w 100W Transformer & Deck Box Kit	265.75
K MCRGB01K	Mini Chroma RGB LED Kit c/w Remote contains 1 RGBW light c/w sync panel 100W Transformer & Deck Box Kit	460.75

Heating Options*

DISCOUNT/ PRODUCT CODE	DESCRIPTION	PRICE EACH
K HSE056	HeatSeeker 5.6kW	1224.00
H 8T89	Electro 9kW	603.00

Filtration Enclosure

DISCOUNT/ PRODUCT CODE	DESCRIPTION	PRICE EACH
L2 WFE100	Standard Wooden Pool Plant Enclosure	350.00

Above
Ground

Counter Current Units

- Operate with air switch button (not supplied)
- PINCC17 - Controls 1 x 3hp pump (13.4amp)
- PINCCDUO - Controls 2 x 3hp pumps (11amp) with one press of air switch, time delay between pumps to reduce start-up current.
- Compact enclosure



Counter Current Controllers

DISCOUNT/ PRODUCT CODE	DESCRIPTION	PRICE EACH
K PINCC17	Counter Current Controller (single pump 13.4a)	110.00
K PINCCDUO	Counter Current Controller (dual pump 11a)	235.00

ESPA Nadorself

DISCOUNT/ PRODUCT CODE	DESCRIPTION	PRICE EACH
K NCP300	Nadorself 300	925.00



ESPA Wiper 3

DISCOUNT/ PRODUCT CODE	DESCRIPTION	PRICE EACH
K WIP300	Wiper3 300 Single Phase 3HP	524.00



See page 43 for further details

Small Eco

HEAVY
ITEM



The Eco range of pools are specifically designed pool packages to give customers the luxury of a complete wooden pool package at a low cost. It measures compact 4m internally (Volume 11500L/2500galls)

FREE
delivery
England and
Wales
mainland

Package contains:

- Redwood Wall Structure
- Two Piece Softwood Top
- Corner Cover Plates
- Internal Stainless Ladder
- External Softwood Ladder
- Felt Underlay for floor
- 0.375mm Plain Blue Liner
- Skimmer and Return Fitting
- 360mm Sand Filter
- 6-way Multiport Valve
- 0.75hp Pump
- Flexible Pipe and Fittings
- Installation Manual



Small Eco

DISCOUNT/ PRODUCT CODE	DESCRIPTION	PRICE EACH
L5 EWP102K	Small Eco Kit	2499.99

Large Eco

HEAVY
ITEM



Made in the UK

The Large Eco is a 5.5m octagonal internally (Volume 21400L/4700galls) and is a great sized pool for most gardens at a fantastic budget.

FREE
delivery
England and
Wales
mainland

Package contains:

- Redwood Wall Structure
- Two Piece Softwood Top
- Corner Cover Plates
- Internal Stainless Ladder
- External Softwood Ladder
- Felt Underlay for floor
- 0.375mm Plain Blue Liner
- Skimmer and Return Fitting
- 360mm Sand Filter
- 6-way Multiport Valve
- 0.75hp Pump
- Flexible Pipe and Fittings
- Installation Manual

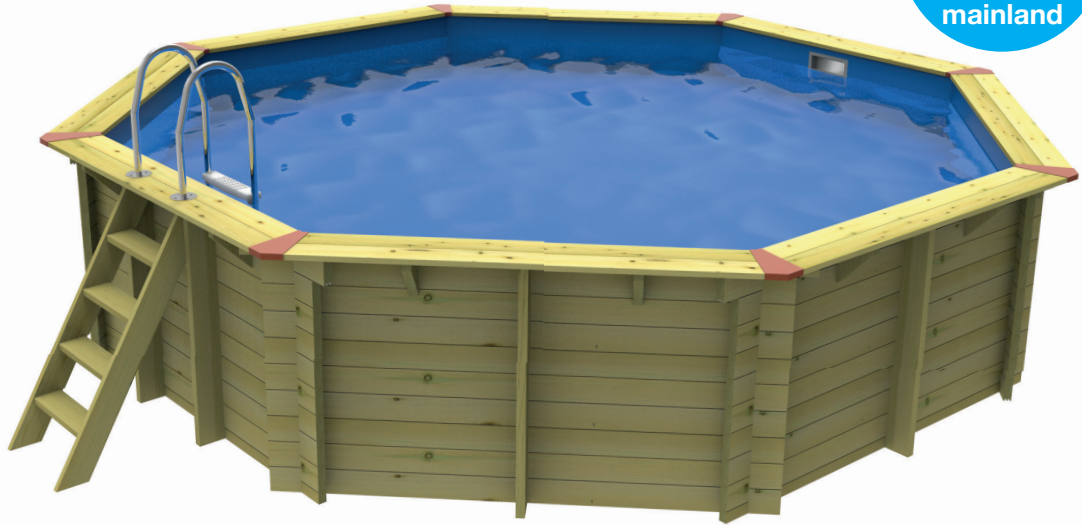

Large Eco

DISCOUNT/
PRODUCT CODE

DESCRIPTION

PRICE
EACH

L5 EWP103K

🔴🟢 Large Eco Kit

3333.00

Large Stretched Eco

HEAVY
ITEM



Made in the UK

The Large Stretched Eco is a great sized pool for families and more serious swimmers at a fantastic budget. (Volume 34200L/7523galls)

FREE
delivery
England and
Wales
mainland

Package contains:

- Redwood Wall Structure
- Two Piece Softwood Top
- Corner Cover Plates
- Internal Stainless Ladder
- External Softwood Ladder
- Felt Underlay for floor
- 0.375mm Plain Blue Liner
- Skimmer and Return Fitting
- 360mm Sand Filter
- 6-way Multiport Valve
- 0.75hp Pump
- Flexible Pipe and Fittings
- Installation Manual



Above
Ground

Large Stretched Eco

DISCOUNT/
PRODUCT CODE

DESCRIPTION

PRICE
EACH

L5 EWP104K

🔴🟢 Large Stretched Eco Kit

4416.66

Wooden Pool Accessories

- Switches pump on when the water falls below set temperature
- Supplied complete with temperature probe
- Digital display of temperature
- Low and high set point are adjustable (on/off)

Frost Stat

DISCOUNT/ PRODUCT CODE	DESCRIPTION	PRICE EACH
K DHG-2	Frost Protection Thermostat Controller	106.00



- Compact design with wired remote time clock for small plant room
- Suitable for 0.75hp to 1hp pumps as standard
- Option to supply circuit breaker for pumps up to 3hp
- Built-in 100w 12v transformer for LED lights

Control Panel

DISCOUNT/ PRODUCT CODE	DESCRIPTION	PRICE EACH
K PI31014LTEID	Control Panel (filtration + 100w transformer)	244.00

Note: When using Mini Chroma RGBW you will require a BRIO-RC instead of the BRIO100-RC supplied in the light kit.

NB: Panel should be mounted inside



Circuit Breakers

DISCOUNT/ PRODUCT CODE	DESCRIPTION	PRICE EACH
K GZ1M07	1.6 - 2.5amp (0.33hp = 2.2amp)	25.60
K GZ1M08	2.5 - 4amp (0.50hp = 3.12amp)	25.60
K GZ1M14	6 - 10amp (1.5hp = 7.6amp)	25.60
K GZ1M16	9 - 14amp (2hp = 10.4amp)	25.60

The above circuit breakers are to replace the standard units supplied with PI31014LTEID and PI310ID Control Panels. The adjustable dial must be set to the correct amp setting, in correspondence with the pumps registration plate.

- Compact design
- No need for conduit or deck box

Mini Chroma Niche

DISCOUNT/ PRODUCT CODE	DESCRIPTION	PRICE EACH
K PF10R192	Mini Chroma Niche for c/w backnut	35.00

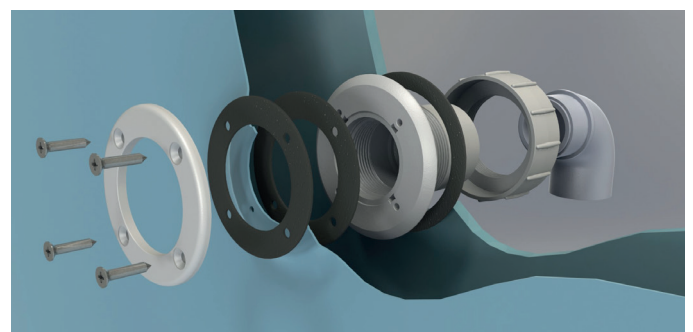



45 YEARS  **Plastica**

**Looking for competitive Above Ground Pool prices?
Why not contact us NOW**

bespoke
POOL SALES 

Bespoke Sales LTD.
sales@bespokepoolsales.co.uk
(UK) Tel: 1 001268 710425

**Above
Ground**

Wooden Fun Pool



- Redwood Walls & Structure
- Single Piece Softwood Top
- Mid Blue Liner and Felt Underlay
- Pipework and fittings
- Installation Guide
- Can be positioned on a flat level lawn
- Filtration upgrade available
- 10ft models include skimmer and inlet cut-out
- 8ft model includes inlet and low level suction cut-out
- Standard packages includes Cartridge Filter
- Upgrade packages includes 0.25hp Filter Pump Pack

FREE
delivery
England and
Wales
mainland

A new addition to the affordable above ground pool market. Aesthetically pleasing to compliment your garden. Can be used above ground or submerged in ground.

Fun pools come with the same great 10 year warranty and quality of manufacture as our Premium Wooden Pools.



8ft Fun Pool



10ft Fun Pool - 4ft depth

Fun Pool		
DISCOUNT/ PRODUCT CODE	DESCRIPTION	PRICE EACH
L5 WFP008K	8ft Fun Pool	666.66
L5 WFP010K	10ft Fun Pool	999.99
L5 WFP010UK	10ft Fun Pool (Upgraded)	1085.32
L5 WFP0104K	10ft Fun Pool - 4ft depth	1166.66
L5 WFP0104UK	10ft Fun Pool - 4ft depth (Upgraded)	1249.99



10ft Fun Pool



Standard Package Filtration
Intex 28638BS



Upgrade Package Filtration
Krystal Klear - 28644



Recommended Ladders
28072 (up to 0.9m models) or 28074
(1.24m deep model)



Recommended Heater
Electro Plug n Play - Nano N-AGP-
UK-T

Above
Ground

Wooden Pool Covers



Made in the UK

Richmond

DISCOUNT/ PRODUCT CODE	DESCRIPTION	PRICE EACH
R WPC903	400 Blue Cover for Richmond Wooden Pool 12m ²	121.50
R3 WPC904	500 Sol+Guard Cover for Richmond Wooden Pool 12m ²	170.40
I PWD003WP	Deluxe Tarp AG WD Cover for Richmond Wooden Pool 18m ²	280.80
V PSV301B	Blue Poolsaver Cover for Richmond Wooden Pool 15m ²	780.00

Knightbridge / Small Eco

DISCOUNT/ PRODUCT CODE	DESCRIPTION	PRICE EACH
R WPC102	400 Blue Cover for Knightsbridge Wooden Pool 14m ²	141.40
R3 WPC101	500 Sol+Guard Cover for Knightsbridge Wooden Pool 14m ²	198.80
I PWD001WP	Deluxe Tarp AG WD Cover for Knightsbridge Wooden Pool 21m ²	327.60
V PSV101B	Blue Poolsaver Cover for Knightsbridge Wooden Pool 18m ²	936.00

Mayfair

DISCOUNT/ PRODUCT CODE	DESCRIPTION	PRICE EACH
R WPC202	400 Blue Cover for Mayfair Wooden Pool 21m ²	212.10
R3 WPC201	500 Sol+Guard Cover for Mayfair Wooden Pool 21m ²	298.20
I PWD002WP	Deluxe Tarp AG WD Cover for Mayfair Wooden Pool 29m ²	452.40
V PSV201B	Blue Poolsaver Cover for Mayfair Wooden Pool 15m ²	1352.00

Hampstead

DISCOUNT/ PRODUCT CODE	DESCRIPTION	PRICE EACH
R WPC802	400 Blue Cover for Hampstead Wooden Pool 26m ²	262.60
R3 WPC801	500 Sol+Guard Cover for Hampstead Wooden Pool 26m ²	369.20
I PWD008WP	Deluxe Tarp AG WD Cover for Hampstead Wooden Pool 35m ²	546.00
V PSV801B	Blue Poolsaver Cover for Hampstead Wooden Pool 32m ²	1664.00

Large Stretched Eco Covers

DISCOUNT/ PRODUCT CODE	DESCRIPTION	PRICE EACH
R WPC902	400 Blue Cover for Large Eco Stretched 39m ²	393.90
R3 WPC901	500 Sol+Guard Cover for Large Eco Stretched 39m ²	553.80
I PWD009WP	Deluxe Tarp AG WD Cover for Large Eco Stretched 49m ²	763.60
V PSV901B	Blue Poolsaver Cover for Large Eco Stretched 46m ²	2392.00

Belgravia Covers

DISCOUNT/ PRODUCT CODE	DESCRIPTION	PRICE EACH
R WPC402	400 Blue Cover for Belgravia Wooden Pool 21m ²	212.10
R3 WPC401	500 Sol+Guard Cover for Belgravia Wooden Pool 21m ²	298.20
I PWD004WP	Deluxe Tarp AG WD Cover for Belgravia Wooden Pool 29m ²	452.40
V PSV401B	Blue Poolsaver Cover for Belgravia Wooden Pool 26m ²	1352.00

Bayswater Covers

DISCOUNT/ PRODUCT CODE	DESCRIPTION	PRICE EACH
R WPC502	400 Blue Cover for Bayswater Wooden Pool 24m ²	242.40
R3 WPC501	500 Sol+Guard Cover for Bayswater Wooden Pool 24m ²	340.80
I PWD005WP	Deluxe Tarp AG WD Cover for Bayswater Wooden Pool 33m ²	514.80
V PSV501B	Blue Poolsaver Cover for Bayswater Wooden Pool 30m ²	1560.00

Westminster Covers

DISCOUNT/ PRODUCT CODE	DESCRIPTION	PRICE EACH
R WPC602	400 Blue Cover for Westminster Wooden Pool 38m ²	383.00
R3 WPC601	500 Sol+Guard Cover for Westminster Wooden Pool 38m ²	440.96
I PWD006WP	Deluxe Tarp AG WD Cover for Westminster Wooden Pool 49m ²	748.80
V PSV601B	Blue Poolsaver Cover for Westminster Wooden Pool 45m ²	2340.00

X-Stream Exercise Pool Covers

DISCOUNT/ PRODUCT CODE	DESCRIPTION	PRICE EACH
R WPC702	400 Blue Cover for X-Stream Exercise Wooden Pool 10m ²	101.00
R3 WPC701	500 Sol+Guard Cover for X-Stream Exercise Wooden Pool 10m ²	142.00
I PWD007WP	Deluxe Tarp AG WD Cover for X-Stream Exercise Wooden Pool 17m ²	218.40
V PSV701B	Blue Poolsaver Cover for X-Stream Exercise Wooden Pool 13m ²	676.00

Chelsea Pool Covers

DISCOUNT/ PRODUCT CODE	DESCRIPTION	PRICE EACH
R WPC1012	400 Blue Cover for Chelsea Wooden Pool 50m ²	505.00
R3 WPC1011	500 Sol+Guard Cover for Chelsea Wooden Pool 50m ²	710.00
I PWD1011WP	Deluxe Tarp AG WD Cover for Chelsea Wooden Pool 63m ²	982.80
V PSV1011B	Blue Poolsaver Cover for Chelsea Wooden Pool 58m ²	3016.00



Above
Ground

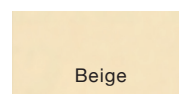
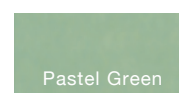

Poolsaver Covers are available in Blue, Green, Pastel Green and Beige colours. Please state which you require when ordering.

Wooden Pool Dimensions

HEAVY
ITEM

When purchasing a Plastica wooden pool, you will be sure to find the help you need to build your product to a high standard.

If the wooden pool requires metal braces, you can pre order them to be delivered before the rest of the pool package you have chosen. This means you can build the recommended concrete base and position your metal braces, well before having your pool delivered. This can save you time and for smaller sites can save you working space.

The wooden structure does not require any further treatment.

On Premium Pools we recommend the use of decking oil to keep your hard wood top shelving in beautiful condition.

All pools are supplied with plan drawing laminates and a self- build installation manual.

For further technical information on Plastica Wooden Pools you can go to www.woodenpools.net. There you can find information such as Metal Brace positions, concrete base drawings, Installation Manuals and more.

	External		Internal			Concrete Base		
	Length	Width	Length	Width	Height	Length	Width	Thickness
Richmond	3.927m	3.927m	3.399m	2.266m	1.177m	4.087m	4.087m	0.150m
Knightsbridge	4.213m	4.213m	3.695m	3.695m	1.177m	4.383m	4.382m	0.150m
Mayfair	5.129m	5.129m	4.611m	4.611m	1.177m	5.299m	5.299m	0.150m
Hampstead	5.600m	5.600m	5.082m	5.082m	1.312m	5.770m	5.770m	0.150m
Belgravia	6.082m	4.212m	5.564m	3.695m	1.312m	6.252m	4.382m	0.150m
Bayswater	7.082m	4.212m	6.564m	3.695m	1.312m	7.252m	4.382m	0.150m
Westminster	8.719m	5.129m	8.201m	4.699m	1.312m	8.889m	5.299m	0.150m
Chelsea	10.518m	5.518m	10.000m	5.000m	1.312m	10.688m	5.688m	0.150m
Exercise	4.434m	2.994m	3.916m	2.426m	1.177m	4.604m	3.114m	0.150m
Riva Exercise	4.434m	2.994m	3.916m	2.426m	1.177m	4.604m	3.114m	0.150m
Eco Small octagon	4.240m	4.240m	3.695m	3.695m	1.177m	4.383m	4.383m	0.150m
Eco Large octagon	5.600m	5.600m	5.082m	5.082m	1.177m	5.770m	5.770m	0.150m
Eco Large Stretched	8.045m	5.600m	7.527m	5.082m	1.177m	8.215m	5.770m	0.150m
10ft Fun pool 3ft deep	3.046m	3.046m	2.817m	2.817m	0.899m	3.734m	3.734m	0.150m
10ft Fun pool 4ft deep	3.046m	3.046m	2.817m	2.817m	1.239m	3.734m	3.734m	0.150m
8ft Fun pool	2.484m	2.484m	2.252m	2.252m	0.739m	3.172m	3.172m	0.150m



Above
Ground

PRICE
HELD FOR
2017



All filter pump units must be placed 2 metres away from the pool. We recommend filtration is turned off when pool is in operation.

- Easy to set up
- Semi-rigid structure
- Made from re-inforced PVC
- Galvanised steel frame
- 12' complete with 2m³ per hour filter pump
- 15' comes with 3.8m³ per hour filter pump, ladder, ground cloth, cover and DVD
- 18' comes with 5.7m³ per hour filter pump, ladder, ground cloth, cover and DVD

Metal Frame

DISCOUNT/ PRODUCT CODE	DESCRIPTION	PRICE EACH
L 28212BS	12' x 30"	177.00
L 28236BS	15' x 48"	434.00
L 28252	18' x 48"	635.00

45 YEARS  **Plastica**

Looking for competitive Above Ground Pool prices?
Why not contact us **NOW**

bespoke
POOL SALES 

Bespoke Sales LTD.
sales@bespokepoolsales.co.uk
(UK) Tel: 1 001268 710425

Above
Ground

Easy Set Pool



All filter pump units must be placed 2 metres away from the pool. We recommend filtration is turned off when pool is in operation.

- Ten minute set up
- Supplied with a pump-filtration system
- Made from re-inforced PVC
- 8' supplied as pool only
- 12' complete with 2m³ per hour filter pump
- 15' complete with 3.8m³ per hour cartridge filter pump, ladder, groundsheet, cover and DVD

Easy Set			PRICE EACH
DISCOUNT/PRODUCT CODE	DESCRIPTION		
L 28110	8' x 30"		43.00
L 28146BS	12' x 36"		129.00
L 28168BS	15' x 48"		310.00

Easy Set Starter Pool

PRICE HELD FOR 2017



- Quick and easy for parents to set-up
- Just the right size for younger kids to enjoy
- Bold aqua colour

Easy Set			PRICE EACH
DISCOUNT/PRODUCT CODE	DESCRIPTION		
L 28101	6' x 20"		29.00

Relax Splasher Water Treatment Kit

- 1kg Stabilised Chlorine Granules
- 0.75kg pH Minus
- 0.5kg pH Plus
- pH / Chlorine Test Strips
- Guide to Operating Splasher Pools

**BULK
PRICES
AVAILABLE**



Relax Splasher Water Treatment Kit

DISCOUNT/ PRODUCT CODE	DESCRIPTION	PRICE EACH
T3 RCH080	Relax Splasher Pool Water Treatment Kit	26.75

Relax Large Above Ground Water Treatment Kit

- 1kg Stabilised Chlorine Granules
- 1.5kg pH Minus
- 1kg pH Plus
- 0.5 Litre Concentrated Algicide
- pH / Chlorine Test Strips
- Guide to Operating Above Ground Pools

**BULK
PRICES
AVAILABLE**



Relax Above Ground Water Treatment Kit

DISCOUNT/ PRODUCT CODE	DESCRIPTION	PRICE EACH
T3 RCH063	Above Ground Pool Water Treatment Kit	47.50

Floating Fountain



Grecian Triple Tier Fountain – NAF100



Grecian Triple Tier Fountain – NAF100

Floating Fountain

DISCOUNT/ PRODUCT CODE	DESCRIPTION	PRICE EACH
L NAF100	Grecian Triple Tier Fountain	34.00

Above
Ground

Skimmers

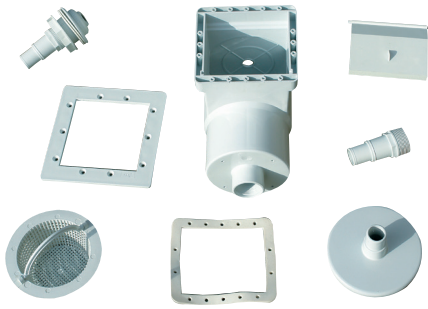

Standard Skimmer – ENS100

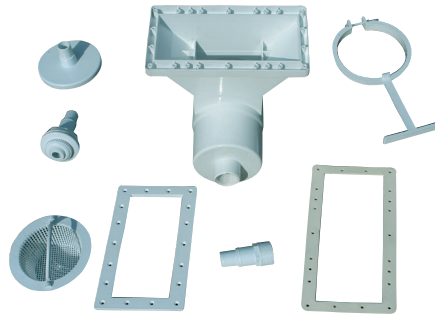

Wide Angle Skimmer – ENS110



Surface Skimmer – 28000/E

Through Wall Skimmer

DISCOUNT/ PRODUCT CODE	DESCRIPTION	PRICE EACH
L ENS100	Standard (1.5" female threaded outlet)	38.00
L ENS110	Wide Angle (1.5" female threaded outlet)	48.00

Wall Mount Surface Skimmer

DISCOUNT/ PRODUCT CODE	DESCRIPTION	PRICE EACH
L1 28000/E	Wall Mount Surface Skimmer	26.50



Surface Skimmer – 28000/E

Cartridge Filter Pump Units

- Easy installation
- Double insulated with air release valve
- Automatic timer

28602BS suitable for 10' Metal Frame, 8' & 10' Easy Set Pool
 28604BS suitable for 12' Metal Frame, 8' & 12' Easy Set Pool
 28638BS suitable for 15' Metal Frame & 15' Easy Set Pool
 28636BS suitable for 18' Metal Frame Pool

Cartridge Filter Pump Units

DISCOUNT/ PRODUCT CODE	DESCRIPTION	PRICE EACH
L 28602BS	1,136 litres per hour	38.00
L 28604BS	1,798 litres per hour	50.00
L 28638BS	2,839 litres per hour	70.00
L 28636BS	4,466 litres per hour	130.00
L 29060	Accessory Hose 1.5m x 38mm	16.30

Type H filter cartridge fits filter model 28602

Type A filter cartridge fits filter models 28604, 28638 and 28636

Type B filter cartridge fits filter model and 28634

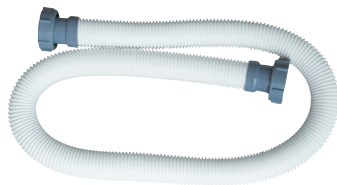

Accessory Hose – 29060



28604BS



28638BS

Above Ground

Cartridges for Above Ground Filter Pump Units

DISCOUNT/ PRODUCT CODE	DESCRIPTION	PRICE EACH
S 29007	Intex Type H Filter Cartridge	3.70
S 29000	Intex Type A Filter Cartridge	4.20
S 29002	Intex Type A Filter Cartridges Twin Pack	8.00
S 29003	Intex Type A Filter Cartridges Triple Pack	11.50
S 29005	Intex Type B Filter Cartridge	9.90

Filter Cartridge Cleaners

DISCOUNT/ PRODUCT CODE	DESCRIPTION	PRICE EACH
S 29082	Multi-function Cartridge Cleaner	6.00
S3 FFLOSSV1	Filter Flossing Cleaning Tool	24.99
S3 FPICV1	Power Pic Cleaning Tool	16.95



Power Pic Cleaning Tool FP1CV1



FilterFlosser Cleaning Tool FFLOSSV1



Multi-function Cartridge Cleaner 29082

Krystal Clear™ Filter Pump Packs

- 6-way multiport valve
- 24 hour automatic timer
- Pressure gauge
- Comes in display box
- Complete with connectors and flexible pipe for Intex pool

Krystal Clear

DISCOUNT/ PRODUCT CODE	DESCRIPTION	PRICE EACH
L 28644	0.25hp 4m³ per hour filter pump pack	199.00
L 28646	0.5hp 6m³ per hour filter pump pack	228.00
L 28648	0.6hp 8m³ per hour filter pump pack	297.00

28644 specification:

- 4m³ per hour flow rate
- 10" (254mm) diameter tank
- 0.25hp pump
- 8.5kg glass media capacity
- 12kg sand media capacity



Connectors and flexible pipe supplied

28646 specification:

- 6m³ per hour flow rate
- 12" (350mm) diameter tank
- 0.5hp pump
- 16kg glass media capacity
- 23kg sand capacity

28648 specification:

- 8m³ per hour flow rate
- 14" (360mm) diameter tank
- 0.6hp pump
- 25kg glass media capacity
- 35kg sand media capacity



Krystal Clear – 28644BS

Krystal Clear

DISCOUNT/ PRODUCT CODE	DESCRIPTION	PRICE EACH
L 56672BS	0.95hp 9.2m³ per hour filter pump pack	249.00

56672BS specification:

- 9.2m³ per hour
- 16" (410mm) diameter tank
- 0.95hp pump
- 38kg glass media capacity
- 55kg sand capacity (not supplied)



Connectors and flexible pipe supplied



Krystal Clear – 56672BS

Rigid Pipe Conversion Kit

DISCOUNT/ PRODUCT CODE	DESCRIPTION	PRICE EACH
L AFP071	Rigid pipe conversion kit	35.90

Converts to 1.5" rigid ABS pipe

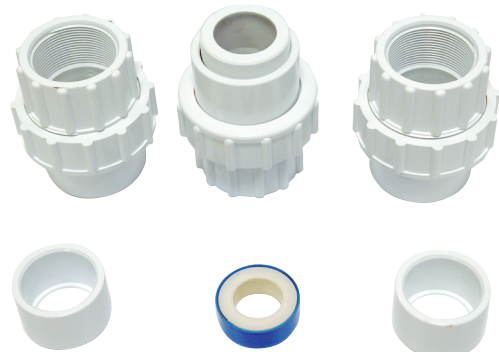

Rigid Pipe Conversion Kit – AFP071

Above
Ground

iFlo™ 500 Filter Pump Pack

- 0.75hp pump
- 500mm blow moulded filter tank
- Outstanding value
- Simple to install
- Ultra quiet, self priming
- Quality 7-way multi-port valve
- Union connectors for quick installation and servicing

iFlo 500

DISCOUNT/ PRODUCT CODE	DESCRIPTION	PRICE EACH
O2 SFP500	Filter Pump Pack	383.00



Azur/FreeFlo™ Filter Pump Pack

- Ideal starter upgrade from small above ground cartridge filters
- Compact sand filter/pump system with multiport valve
- Single piece thermoplastic moulded tank
- Union connectors for quick installation and servicing

Azur/FreeFlo™ Filter Pump Pack

DISCOUNT/ PRODUCT CODE	DESCRIPTION	PRICE EACH
O FS-15A6-FF10	0.33hp Pump, 375mm Filter, 6-way Valve	489.00
O FS-19A6-FF12	0.5hp Pump, 475mm Filter, 6-way Valve	540.00
O FS-22A6-FF15	0.75hp Pump, 560mm Filter, 6-way Valve	607.00



Nano Plug & Play Heater



Made in the UK

- Titanium elements
- Safety thermal cut-out included (manual reset)
- 2m power cord with UK plug
- 230V single phase 13amp load
- Flow switch - no pump interlock required
- Fully pre-wired
- Control thermostat
- 3 year warranty

Supplied connection options:

- 1.5" female threaded
- 50mm plain female socket unions
- 1.5" plain female socket unions
- 1.5" / 1.25" hometail connectors

Nano Plug & Play Heater

DISCOUNT/ PRODUCT CODE	DESCRIPTION	PRICE EACH
H N-AGP-UK-T	3kW	331.60



Can be mounted horizontal or vertical

Elecro EVO Electric Heaters with Titanium Elements



- Titanium elements
- Reversible flow switch
- No pump interlock is required
- Fully controlled with Schneider contactor for super safe operation
- May be wall or floor mounted using swivel foot
- BS 316L Stainless Steel flow tube (ENI.4432) as standard
- ABS Solvent weld unions for 1.5"/50mm rigid pipe and hose tails for 1.25"/1.5mm flexible pipe
- 100% operational efficiency throughout product life
- 3 year warranty



Single Phase

DISCOUNT/ PRODUCT CODE	DESCRIPTION	PRICE EACH
H 8T83 3kW		548.00
H 8T84 4.5kW		553.00
H 8T86 6kW		560.00
H 8T89 9kW		603.00
H 8T8A 12kW		617.00
H 8T8B 15kW		685.00
H 8T8C 18kW		736.00

Single Phase

Power Output	Volt	Amp
3kW	230v	13
4.5kW	230v	20
6kW	230v	27
9kW	230v	40
12kW	230v	53
15kW	230v	66
18kW	230v	79

Intex 2kW Heater

- Compatible with Easy Set or Metal Frame pools (up to 12')
- 220-240v
- Easy setup and operation
- Water level sensor
- New or retro-fit
- Includes thermometer



Intex 2kW Heater

DISCOUNT/ PRODUCT CODE	DESCRIPTION	PRICE EACH
L 28684	🔌 Intex 2kW Heater	134.00

Above
Ground

Solar Pod™

- For above ground pools up to 4,500 litres
- Compact size of 580mm x 580mm
- Coil made of strong polypropylene
- Strong transparent polycarbonate dome
- Easy connection
- Connect multiple units for larger pools
- Works with existing pool pump*
- Minimal tools required (Philips screwdriver and silicon lubricant)
- Tilts to achieve best angle for sun
- No servicing required (other than winterising)



- Solar Pod includes:
- 1m and 0.36m hoses
 - Main base with stand
 - 1.25" to 1.5" hose reducer
 - Collared tube adaptor
 - Hose clamps
 - Side hose connector x2
 - Hose ID 38mm
 - Clear dome
 - Solar protection cover

Solar Pod™

DISCOUNT/ PRODUCT CODE	DESCRIPTION	PRICE EACH
K POD001	Solar Pod	95.00
K POD051	Solar Pod Accessories Kit	10.50
K POD053	Additional Hose (Short – 375mm x 1.5")	6.35
K POD054	Additional Hose (Long – 975mm x 1.5")	16.80

Note: For use with Intex standard filtration you will need to purchase 1.25" hose (see page 163).

Note: The heating efficiency of Solar Pods is directly related to climatic conditions. Plastica cannot guarantee that solar heating will maintain a constant pool temperature and recommend installation of a secondary heat source.

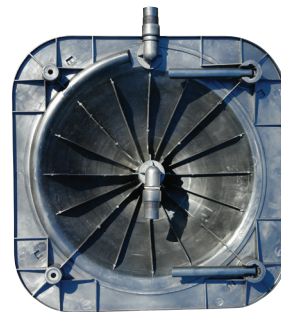

Solar Pod Accessories Kit –
POD051

Note: Any more than 3 Solar Pods should be plumbed in parallel.

Solar Pod™ Plus

- For above ground pools up to 9,000 litres
- 780mm x 780mm x 450mm
- Coil made of strong polypropylene
- Strong transparent dual polycarbonate domes
- Easy connection
- Connect multiple units for larger pools
- Works with existing pool pump*
- Minimal tools required (Philips screwdriver and silicon lubricant)
- Tilts to achieve best angle for sun
- No servicing required (other than winterising)
- Reflective underside for optimum heat gain



- Solar Pod Plus includes:
- Hose ID 38mm
 - Main base with stand
 - 1.25" to 1.5" hose reducer
 - Collared tube adaptor
 - Hose clamps
 - 1m and 0.36m hoses
 - Side hose connector x2
 - Clear dome
 - Solar protection cover

Solar Pod™ Plus

DISCOUNT/ PRODUCT CODE	DESCRIPTION	PRICE EACH
K POD002	Solar Pod Plus	199.00
K POD052	Solar Pod Plus Accessories Kit	13.00
K POD053	Additional Hose (Short – 375mm x 1.5")	6.35
K POD054	Additional Hose (Long – 975mm x 1.5")	16.80



Solar Pod Plus
Accessories Kit – POD052

Note: The heating efficiency of Solar Pods is directly related to climatic conditions. Plastica cannot guarantee that solar heating will maintain a constant pool temperature and recommend installation of a secondary heat source.

Above Ground Solar Heating Panels

Kit consists of

- 0.61m x 6.1m Solar Panel
- 2 x End Stops
- 1 x Connector Hose
- 2 x Jubilee Clips
- 2 x Threaded Connector (1.5")
- 1 x PTFE Tape



Solar Heating Panels

DISCOUNT/ PRODUCT CODE	DESCRIPTION	PRICE EACH
L SOM001	Solar Heating Kit 0.61m x 6.1m	180.80
L SOM010	Hardware Kit	43.95
L SOM011	Connector Hose	9.40
L SOM050	Roof Mounting Kit	52.50
L SOM060	High Wind Kit	35.00
L SOM070	Diverter Valve Kit	52.50

Note: Roof Mounting Kit is still required with High Wind Kit.



Diverter Kit – SOM070



High Wind Kit – SOM060



Roof Mounting Kit – SOM050



Hardware Kit – SOM010

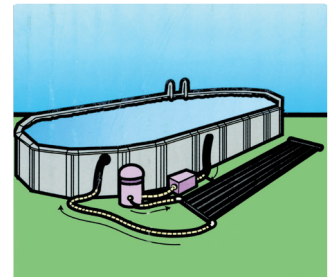
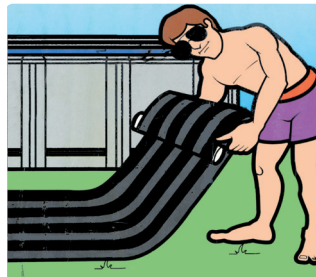
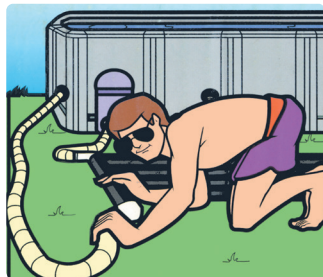
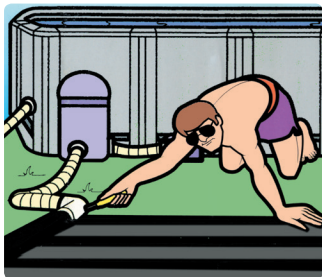

Recommendations for Round Pools

Pool Diameter (feet)	Pool Diameter (metres)	Recommended No. of Panels
8ft	2.4m	1
12ft	3.6m	3
15ft	4.5m	4
18ft	5.4m	5
24ft	7.3m	9

Recommendations for Wooden Pools

Pool Diameter (feet)	Pool Diameter (metres)	Recommended No. of Panels
13ft Octagonal	4m Octagonal	3
16ft Octagonal	5m Octagonal	5
20ft Octagonal	6m Octagonal	6
12ft x 18ft	4m x 5.9m	4
12ft x 22ft	4m x 6.9m	5

Recommendations for Oval Pools

Pool Diameter (feet)	Pool Diameter (metres)	Recommended No. of Panels
16ft x 10ft	4.8m x 3m	3
12ft x 24ft	3.7m x 7.4m	6
12ft x 32ft	3.7m x 9.7m	8

Note: The heating efficiency of Solar Panels is directly related to climatic conditions. Plastica cannot guarantee that solar heating will maintain a constant pool temperature and recommend installation of a secondary heat source.

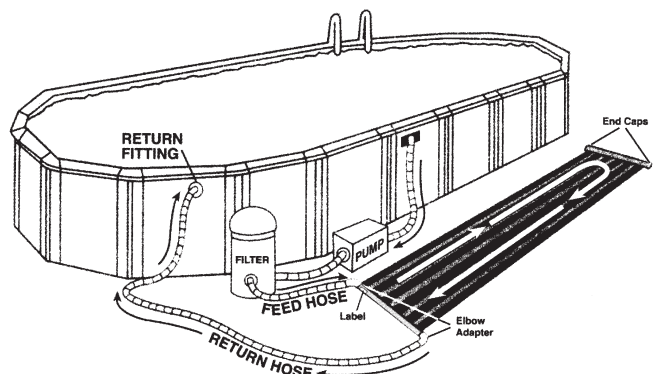

Wooden Pool Ladder



- Stainless steel ladder attaches to wooden top rail
- For any depth of pool

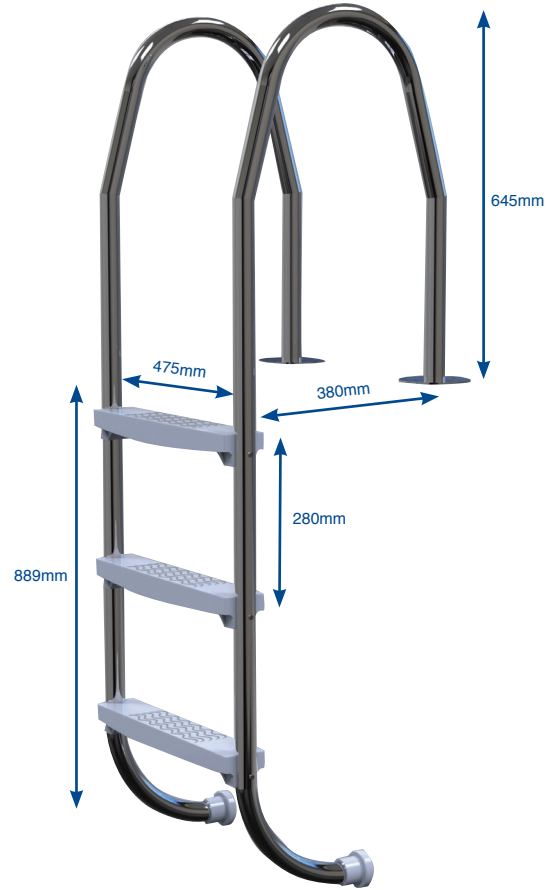

Wooden Pool Ladder

DISCOUNT/ PRODUCT CODE	DESCRIPTION	PRICE EACH
D PSL600AK	3-Tread	340.00
D PSL600AKR	3-Tread removable	365.00
S ESC001	Cover Plate to suit PSL600AK	18.85

Decking Ladder

- Stainless steel adjustable ladder
- 48-52" depth pools
- Level of decking can be up to 0.2m below top of pool
- Stainless steel sliding flange adjusts height

Decking Ladder

DISCOUNT/ PRODUCT CODE	DESCRIPTION	PRICE EACH
D PSL601AK	4-Tread	386.00

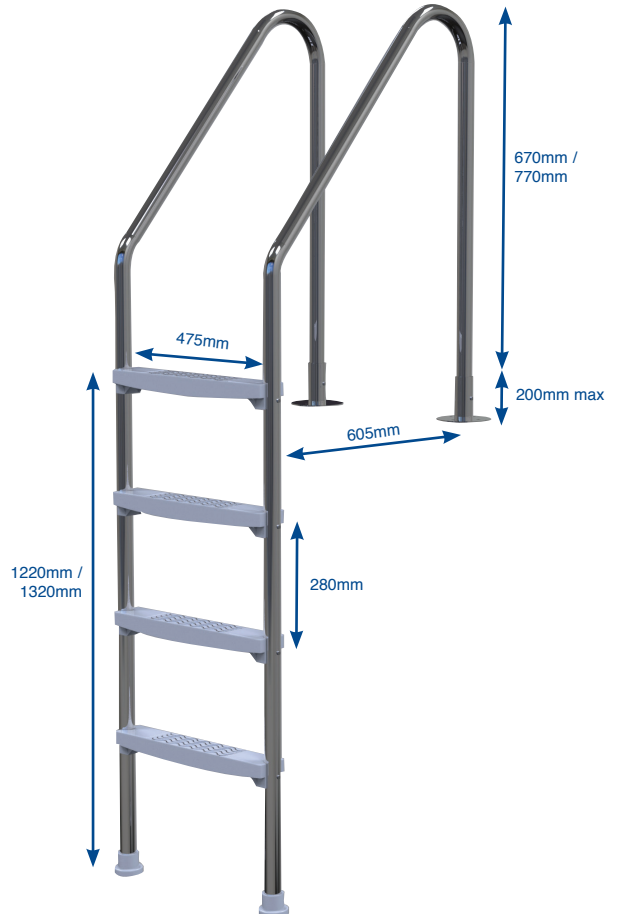

Above
Ground

Above Ground Pool Ladders

- Removable outside staircase
- Bridge type construction
- 520mm width
- Handrail height selection
- Easy 8 piece assembly
- One piece staircase

Decking Ladder

DISCOUNT/ PRODUCT CODE	DESCRIPTION	PRICE EACH
N ZAP320 48"/52"		227.50



42" Ladder – 28061
48" Ladder – 28062



36" & 42" Ladder – 28072
48" & 52" – 28074

Above Ground Pool Ladders

DISCOUNT/ PRODUCT CODE	DESCRIPTION	PRICE EACH
L 28061 42"		54.00
L 28062 48"		79.00
L 28072 36" and 42" with removable steps		88.30
L 28074 48" and 52" with removable steps		117.00

- Coated steel frame
- High impact plastic steps
- For pool walls 36" to 52" high
- Models 28072 and 28074 have removable steps

Foot Bath

- Reduces debris and dirt from entering the pool
- Perfect for all Intex ladders
- Anti-slip bottom for safety
- Size 56cm x 46cm x 9cm
- 11.5 litres water capacity

Foot Bath

DISCOUNT/ PRODUCT CODE	DESCRIPTION	PRICE EACH
L 29080 Foot Bath		6.70



Above Ground Pool Liners

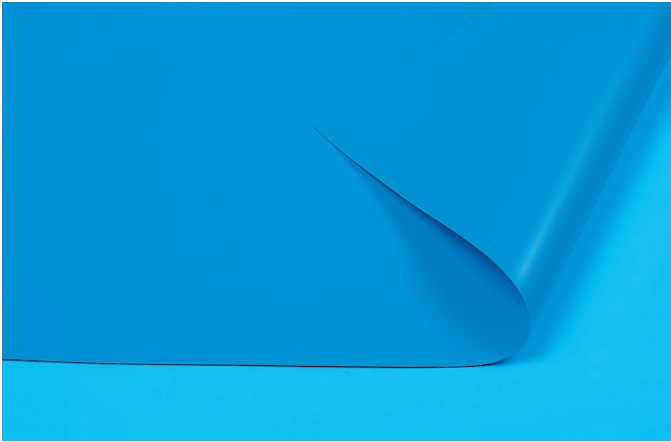

• Overlap Liners

Economy Diameter Liners

DISCOUNT/ PRODUCT CODE	DESCRIPTION	PRICE EACH
L SAL012	12' x 3'	98.00
L SAL215	15' x 3'6"	144.00
L SAL018	18' x 4'	238.00
L SAL024	24' x 4'	350.00

Vinyl Liners – 16 thou (0.4mm)

DISCOUNT/ PRODUCT CODE	DESCRIPTION	PRICE EACH
L PLA400	Per sq. m.	11.10

Note: Liners are pool size

45 YEARS  **Plastica**

Looking for competitive Above Ground Pool prices?
Why not contact us NOW

bespoke
POOL SALES 

Bespoke Sales LTD.
sales@bespokepoolsales.co.uk
(UK) Tel: 1 001268 710425

Above Ground Pool Solar Covers

- Budget solar cover for above ground pools
- Reduce heating costs and chemical usage
- 200 micron
- 0.22kg per sq.m
- 1 year pro-rata warranty (UK & Eire only)

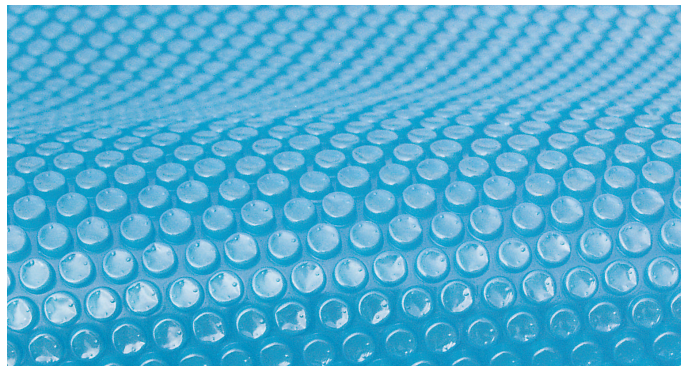

Note: These covers require trimming on site

Oval

DISCOUNT/ PRODUCT CODE	DESCRIPTION	PRICE EACH
L ASC112	10' x 15'	47.90
L ASC113	10' x 16'	48.40
L ASC114	12' x 18'	62.70
L ASC117	12' x 20'	67.50
L ASC122	12' x 22'	72.70
L ASC124	12' x 24'	78.05
L ASC126	12' x 28'	89.25
L ASC132	16' x 28'	111.25
L ASC118	15' x 30'	112.45
L ASC134	16' x 32'	124.10
L ASC136	18' x 33'	143.15

Diameter

DISCOUNT/ PRODUCT CODE	DESCRIPTION	PRICE EACH
L ASC008	8'	24.80
L ASC010	10'	32.10
L ASC012	12'	37.50
L ASC015	15'	61.65
L ASC016	16'	69.90
L ASC018	18'	84.80
L ASC024	24'	148.45

Premium Wooden Pool Solar Covers

- Budget solar cover for wooden pools
- Reduce heating costs and chemical usage
- 200 micron
- 0.22g per sq.m
- 1 year pro-rata warranty (UK & Eire only)



Note: These covers require trimming on site

Premium Wooden Pool

DISCOUNT/ PRODUCT CODE	DESCRIPTION	PRICE EACH
L WPC100	Cover for 4m Knightsbridge	45.60
L WPC200	Cover for 5m Mayfair	65.65
L WPC300	Cover for 6m Kensington	86.00
L WPC400	Cover for 5.5m x 3.6m Belgravia	64.50
L WPC500	Cover for 6.5m x 3.6m Bayswater	70.50
L WPC600	Cover for 8.1m x 4.6m Westminster	99.50
L WPC700	Cover for 4.2m x 3.9m Exercise Pool	32.00

Above
Ground

Cover Repair

Cover Repair

DISCOUNT/ PRODUCT CODE	DESCRIPTION	SUITABLE FOR	PRICE EACH
PLR150	Cover Repair Tape 50mm x 33m roll	All covers	8.40
PLR255	Repair Material 0.15m (6") wide per m	Supercovers	1.65
PLR230	Cover Repair Kit (4 patches per kit)	All covers	3.50



Premium Reel System

- Anti-spin locking device on wheels
- Complete with connectors for new or existing covers
- Tube extends from 3.66m to 5.49m
- Maximum area of cover 50 sq.m.

Above Ground Reel

DISCOUNT/ PRODUCT CODE	DESCRIPTION	PRICE EACH
G2 ERC310 Above Ground		409.00

- 2 fixed stands
- Height adjustable
- Fixed to the pool side

Deck Reel

DISCOUNT/ PRODUCT CODE	DESCRIPTION	PRICE EACH
G2 ERC320 Decking		458.00

- Ideal for wooden pools or decked surrounds
- One fixed end fastens to the surround
- Universal joint enables reel to be moved away from pool side

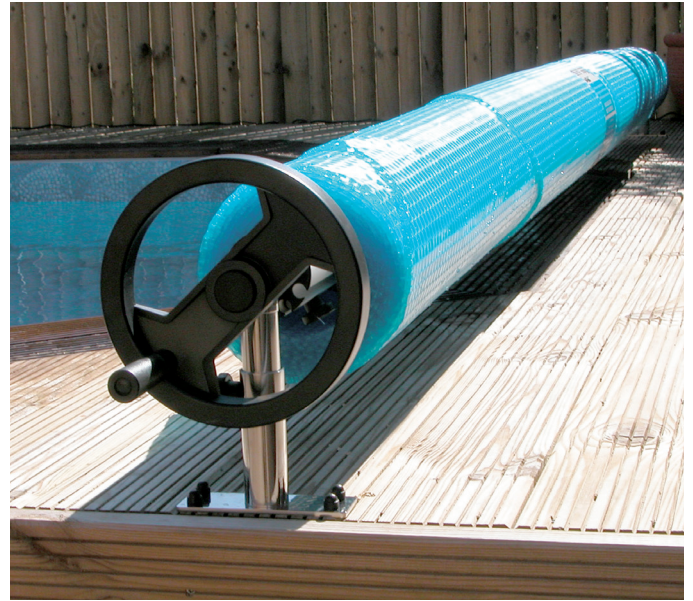

Above Ground – ERC310

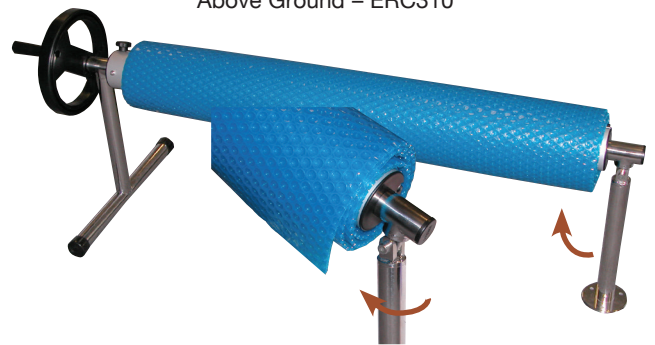

Decking Reel – ERC320

Deluxe Above Ground Pool Covers

MADE
TO
ORDER

- New made to measure Above Ground Pool covers
- Choice of materials
- Mesh Weave material that allows rainwater to pass through
- Deluxe Tarpaulin material that blocks all debris and light
- Use during the Summer or Winter
- Comes complete with elasticated tie-downs and wall clips

Deluxe Above Ground Pool Covers

DISCOUNT/ PRODUCT CODE	DESCRIPTION	PRICE EACH
L PWD100	Mesh Weave Above Ground Debris per m ²	12.45
L PWD200	Deluxe Tarpaulin Above Ground Debris per m ²	15.60

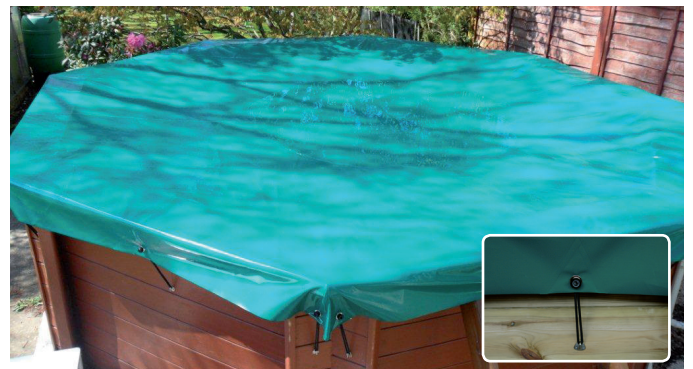

Premium Wooden Pool Debris Covers

Premium Wooden Pool

DISCOUNT/ PRODUCT CODE	DESCRIPTION	PRICE EACH
L PWA115	Cover for 4m Knightsbridge	78.00
L PWA118	Cover for 5m Mayfair	103.00
L PWA120	Cover for 6m Kensington	131.00
L PWA225	Cover for 5.5m x 3.6m Belgravia	127.00
L PWA229	Cover for 6.5m x 3.6m Bayswater	132.00
L PWA233	Cover for 8.1m x 4.6m Westminster	180.00
L PWA216	Cover for Exercise Pool Cover	59.00



Intex Winter Debris Covers

Easy Set

DISCOUNT/ PRODUCT CODE	DESCRIPTION	PRICE EACH
L 28020	8'	10.00
L 28022/E	12'	17.60
L 28023/E	15'	23.80

Metal Frame

DISCOUNT/ PRODUCT CODE	DESCRIPTION	PRICE EACH
L 28031	12'	20.20
L 28032	15'	27.80



Above Ground Winter Debris Covers

- Woven polyethylene
- Comes complete with Winch and Cable

Oval

DISCOUNT/ PRODUCT CODE	DESCRIPTION	PRICE EACH
L PWA214	8' x 12'	42.00
L PWA215	10' x 15'	59.00
L PWA216	10' x 16'	59.00
L PWA224	12' x 24'	103.50
L PWA225	15' x 21'	127.00
L PWA229	16' x 28'	132.00
L PWA230	15' x 30'	142.50
L PWA232	16' x 32'	154.00
L PWA233	18' x 33'	180.00

Diameter

DISCOUNT/ PRODUCT CODE	DESCRIPTION	PRICE EACH
L PWA112	12'	61.00
L PWA115	15'	78.00
L PWA116	16'	82.00
L PWA118	18'	103.00
L PWA120	21'	131.00
L PWA124	24'	155.00

These covers are not porous so a cover pump can be used to remove excess water (page 170)



Winch & Cable

DISCOUNT/ PRODUCT CODE	DESCRIPTION	PRICE EACH
K ACW1001	Aluminium Cable Winch	8.00
K VCCC100	Vinyl Coated Cover Cable 100ft	22.00

Air Pillow

DISCOUNT/ PRODUCT CODE	DESCRIPTION	PRICE EACH
L PWA300	1.2m x 1.52m inflated	25.00

(Two pillows are recommended for ovals over 12' x 20')

Cover Saver



Cover Saver

DISCOUNT/ PRODUCT CODE	DESCRIPTION	PRICE EACH
L ACS001	Above Ground Cover Saver Syphon Device	20.00

Pool Maintenance Kit

- For in-ground and wooden pools
- Complock Pole
- Deep Leafnet
- Triangular Vacuum Head
- Vacuum Hose
- Brush



Pool Maintenance Kit

DISCOUNT/ PRODUCT CODE	DESCRIPTION	PRICE EACH
M PMK100K 🌟	Small (with 9m Vac Hose)	125.00
M PMK300K 🌟	Large (with 12m Vac Hose)	144.00

Magic Vac Maintenance Kit

- Economic above ground pool maintenance kit

Magic Vac Maintenance Kit

DISCOUNT/ PRODUCT CODE	DESCRIPTION	PRICE EACH
L MMK100 🌟	Magic Vac Maintenance Kit	24.50



Above Ground Suction Cleaner

- Connects to skimmer or dedicated suction line
- Easy installation
- Quiet operation
- Suitable for all pool types
- Supplied with 10m of hose in sections

Suction Cleaner

DISCOUNT/ PRODUCT CODE	DESCRIPTION	PRICE EACH
H2 PAC002	Cleaner	90.00

Note: Requires a minimum of 0.5hp pump for correct operation



Bespoke Sales LTD.
 sales@bespokepoolsales.co.uk
 (UK) Tel: 1 001268 710425

Intex Standard Pool Maintenance Kits

- 2.39m Telescopic Pole
- Interchangeable vacuum and skimmer heads
- For use with pools up to 16'

Intex Pool Maintenance Kit

DISCOUNT/ PRODUCT CODE	DESCRIPTION	PRICE EACH
M 28002/E 🌟 Standard		16.20



Intex Deluxe Pool Maintenance Kits

- 2.79m Telescopic Pole
- Vacuum sucks debris off pool wall and through filter
- Durable and deep mesh skimmer net
- Attaches to the pool outlet connector with a 7.5 hose
- For use with pools up to 18'
- Requires a pump with minimum flow rate of 800 gallons p/h

Intex Pool Maintenance Kit

DISCOUNT/ PRODUCT CODE	DESCRIPTION	PRICE EACH
M 28003/E 🌟 Deluxe		41.60



Hand Held Vacuum Kit

- Suitable for all pools and spas
- Easy to configure
- Various attachments
- Wall clip storage

Hand Held Vacuum Kit

DISCOUNT/ PRODUCT CODE	DESCRIPTION	PRICE EACH
K DSP917 Vacuum Kit		33.00



Above
Ground

Above Ground LED Light

- Fixes to inlet
- 216 LED's
- Multi-colour RGB
- 11 static colours, 5 colour sequences
- Remote control can operate upto 5 lights
- 12v 16W
- Energy Rating B



LED Light

DISCOUNT/ PRODUCT CODE	DESCRIPTION	PRICE EACH
K LED005	⊕ Above Ground	175.00

Above
Ground

45 YEARS  **Plastica**

Contact us now to order your
Above Ground requirements

bespoke
POOL SALES 

Bespoke Sales LTD.
sales@bespokepoolsales.co.uk
(UK) Tel: 1 001268 710425